

SOUNDPRO®
SOUND LEVEL METERS
SERIES SE/DL
USER MANUAL



SOUNDPRO® SOUND LEVEL METERS SERIES SE/DL

Dangers, Warnings, Cautions & Battery



DANGER!

Failure to observe the following procedures may result in serious personal injury

- Not for use in explosive or hazardous locations. This product is **not** intrinsically safe.



WARNING!

Failure to observe the following procedures could damage the instrument

- Read the manual before operation.
- **DO NOT** store in temperatures exceeding 60°C (140°F).
- **DO NOT** immerse in liquids.
- Condensation may damage your instrument.
- Substitution of components may impair the accuracy of the instrument. Repair should be performed by authorized service personnel only.



Caution!

General

- The battery in this instrument has limited shelf life, even if never used.
- A non-condensing environment is required for proper measurements.

Intended Use:

The SoundPro meter measures sound pressure levels in air. Consult your company's safety professional for local standards, or call TSI at 1-800-680-1220 (USA) or (651) 490-2860.

ii



Intended Use:
Octave bands

(This page intentionally left blank)

TABLE OF CONTENTS

Dangers, Warnings, Cautions & Battery	i	Navigating	18
Intended Use:	i	Turning off	18
Introduction	1	Basic setups	19
Models and options	1	Changing microphone settings	20
Frequency resolution	2	Time and date	21
Octave bands	2	Measurement type (SLM, 1/1, 1/3, STI-PA, RT60)	22
Third -octave bands	3	Meter 1/Meter 2 Parameters (i.e. response time, weighting)	23
Naming bands	3	Measurement setup (for community noise)	24
Analysis type	4	C-A measurement settings	26
Logging explained	5	Logging	27
Physical Characteristics	5	Logging options	27
The Display	5	Exceedance level	27
Hardware interfaces	5	Filters	27
Memory card slot	6	Logging interval	27
USB port	6	Setting logging options	28
AC/DC port	6	Setting up display options	29
Power jack	6	Language	30
Auxiliary port	6	Backlight	31
Information screen	7	Contrast	32
Screen contents	7	Advanced setups	33
Detection Management Software DMS	7	Auto-Run	33
DMS Start Page	8	Setting up auto-run	33
Getting Started	9	Date setting	34
Checking the equipment	9	Days of week setting	36
Installing the preamp	10	Auto-run shutdown screen	37
Microphone and accessories	10	Auto-run shutdown screen explained	38
Class/Type 1 and Class/Type 2 instrument	11	Timed run setting	38
Windscreen	11	Level-triggered auto-on setting	39
Providing power	12	Locking setup or run mode	41
Installing Batteries	12	Setting secure run or secure setup (locking)	41
Battery power explained	13	About Secure Run	41
Checking or changing type	13	About Secure Setup	42
Using power supply or auto adapter	15	Disabling secure run or secure setup (unlocking)	44
Turning on	15	Secure code backup number	44
Start screen and the keypad	16	Digital outputs/Triggering	45
SoundPro functionality	17	Tracking runs	45
The keypad explained	17	Digital outputs and SPL	46
Indicators explained	18		

Communications	46	Additional options	69
DMS/Serial	47	Reverberation	69
Mass Storage	47	Reverberation time (RT60).....	69
Viewing real-time measurements remotely	48	Reverberation (RT60) methods	71
GPS	49	Interrupted noise	71
GPS display	49	Impulse noise	71
GPS explained.....	49	Reverberation options.....	72
Preparing to measure and running	51	Setting up reverberation.....	73
Virtual meters	51	Running reverberation test.....	74
Meter 1/Meter 2 explained.....	51	Reverberation results.....	75
Measurement notation (IEC/ISO)	51	RT60 summary screen.....	75
Overview of running a session/study	52	Viewing RT60 values of each band.....	76
Preparing to measure	53	Deleting RT60 value in a filtered band	76
Sessions and Studies	53	Decay curve screen	77
Measurement range	54	Tabular RT60 screen	78
Calibrate	55	Curves	78
Calibration screen	55	Captured curves	79
Pre-Calibration	55	Captured curve applications	79
Post-Calibration	55	Setting up captured curves	80
Performing a calibration	56	Running captured curves	81
Running a session/study	58	Criterion curve families	82
Measurement navigation	59	Types of Criterion Curves	83
Using soft keys in measurement screens.....	59	Setting up criterion curves	83
Changing displayed measurement	59	Audiometric background curves	85
Analysis type, time response and weighting.....	60	Setting up audiometric background curves.....	85
Measurement screen icons	61	Running and viewing curves	87
Descriptor types	61	Curve measurements and results	87
Measurement screens	62	Speech Intelligibility	89
Bar Chart and Filtered Bar Chart.....	62	STI-PA testing.....	89
Community Noise screen	63	Zones	89
Dosimetry screen	63	Selecting STI scale or CIS scale.....	89
Dosimetry measurements.....	64	STI scale	89
Tabulation screens	64	Common Intelligibility Scale (CIS).....	89
1/1 and 1/3 octave analysis measurement results	64	When to take STI-PA readings?.....	90
Time History/Back-erase screen	65	Conducting a STI-PA test (overview of steps)	90
Back-erasing	65	STI-PA setup.....	91
Results of back-erasing	65	Conducting a level setup (for STI-PA)	93
Stopping a session	67	Running a speech intelligibility study	93
Stopping and pausing	67	STI-PA results screens	94
RT60, Curves, and STI-PA	69	STI-PA measurement and scale results screen	94
		STI-PA modulation screen	94
		STI-PA modulation envelope screen.....	96

Storing background noise/capture curve	96	Instrument noise.....	118
Applying captured curves for STI-PA testing.....	98	Environmental effects	118
Viewing Past Measurements	101	Temperature	118
Files	101	Humidity	118
File directories	101	User interface	119
File directory screen explained.....	102	Display	119
Viewing past sessions/studies (review mode)....	102	Keypad.....	119
Loading and deleting files.....	105	Languages	119
Session directory	106	Input/output	119
Navigating in a session/config. directory	106	Microphones	120
Naming and renaming files	107	AC/DC outputs.....	121
Configuration directory.....	108	Communications ports	121
Saving (& naming) setup file (config. file)	108	Measurements	121
Viewing, loading, deleting setup files (config.) ...	109	Types	121
Memory card	109	Ranges.....	121
Compatibility.....	110	Measurement parameters.....	121
Formatting a card with the SoundPro Sound Level		Other.....	122
Meter	110	Calibration	122
Communicating	111	Studies and sessions	122
Communicating with a PC	111	Special features	122
Using Detection Management Software DMS....	111	Security.....	122
Using an external card reader	111	Back-erase.....	122
Working with measurement data in DMS	111	Logging (optional)	123
DMS and working with SoundPro data.....	112	Part numbers.....	123
AC/DC output	113	Replacement parts.....	123
AC output	113	Optional parts.....	123
DC output	113	Port pinouts.....	124
Specifications	115	AC/DC jack	124
Conformance to standards.....	115	Auxiliary connector.....	125
Acoustics	115	Block Diagram for SoundPro Sound	
EMC emissions and immunity	115	Level Meter	126
References	115	Glossary of Terms	127
Mechanical characteristics.....	116	Customer service.....	137
Electrical characteristics	116	Technical Support Contacts.....	137
Power sources	116	Service Contact Information.....	137
Preamplifier (removable)	117	Returning for Service	138
Meters.....	117	Calibration	138
Bandwidth.....	117	Warranty	139
Octave filters (optional).....	118	Index.....	141
Third-octave filters (optional).....	118		

FIGURES

1-1: SoundPro Models SE and DL and Option 1 and Option 2	1	4-13: Digital-Out screen	45
1-2: Octave bands.....	2	4-14: QSP/Serial	47
1-3: Third Octave bands	3	4-15: Mass Storage	47
1-4: Hardware Interface Panel.....	5	4-16: Log to Port.....	48
1-5: The Unit Information screen	7	4-17: Comm-Set screen for GPS data	49
2-1: Identify SoundPro equipment	9	4-18: Viewing GPS coordinates in COMM-Set screen	50
2-2: SoundPro & Preamp.....	10	5-1: Bar chart screen (A) and Filtered Bar Chart (B).....	54
2-3: SoundPro with microphone and windscreen ..	11	5-2: Attaching calibrator to SoundPro	56
2-4: Installing batteries.....	12	5-3: Setting pre-cal screen	57
2-5: Battery check screen	13	5-4: Calibration history screen.....	57
2-6: Selecting Setup in the Start Screen.....	14	5-5: Post-Calibrate history screen	58
2-7: Selecting battery type in battery check screen	14	5-6: Bar Chart screen in run mode	58
2-8: Attaching the charger adapter with the plug adapter	15	5-7: Selecting measurements with Lookup soft key.....	60
2-9: Base (or bottom) of SoundPro	15	5-8: Example measurement icons & descriptors....	61
2-10: SoundPro SE/DL start screen and keypad	16	5-9: Bar Chart screen and Filtered Bar Chart screen.....	62
3-1: Microphone Settings (Signal Input screen).....	20	5-10: Community Noise screen	63
3-2: Time and Date Settings	21	5-11: Dosimetry screen	63
3-3: Measurement type and start screen	22	5-12: Tabulation screen for octave filtering	64
3-4: Meter 1 and Meter 2 parameters	23	5-13: Back-erasing	65
3-5: Measures screen for community noise settings.....	24	5-14: Time Log screen	66
3-6: C-A measurement settings for Meter 1 and Meter 2.....	26	5-15: Stopping and pausing	67
3-7: Logged Data Chart example.....	27	6-1: Reverb Time.....	70
3-8: Logging screen explained.....	28	6-2: Interrupted noise example.....	71
3-9: Display setup screen	29	6-3: Reverb Time Setup screen	73
3-10: Language screen.....	30	6-4: Reverb Time Setup screen	75
3-11: Backlight setting.....	31	6-5: RT60 bar chart screen	76
4-1: Auto-Run with Date selected	34	6-6: Decay curve screen	77
4-2: Setting Date parameters for Auto-Run #1	35	6-7: Tabular octave filtering RT screen	78
4-3: Example of setting up Auto-Run (QSP-II).....	36	6-8: Selecting measurement type for curves.....	80
4-4: Day of the Week (DOW) setup	37	6-9: Captured Curves and Survey mode.....	81
4-5: Auto-Run Shutdown screen.....	37	6-10: Selecting 1/1 or 1/3 for measurement type	81
4-6: Timed Run setup screen.....	38	6-11: Capturing a curve (CAP-1).....	82
4-7: Level-Triggered screen.....	39	6-12: Selecting measurement type for curves.....	83
4-8: Secure/Lock option	42	6-13: Curves setup screen example.....	84
4-9: Secure/Lock screen	42	6-14: 1/1 or 1/3 octave measurement type for audiometric testing	85
4-10: Adding code for secure/lock screen.....	43	6-15: Selecting measurement type for curves.....	86
4-11: Secure/lock run prompt.....	43		
4-12: Secure/lock setup prompt.....	44		

6-16: Audiometric booth setup in the curves screen	86	7-3: File menu screen.....	103
6-17: Curve results.....	88	7-4: Data File screen	103
6-18: Measurement type selection (STIPA)	92	7-5: Selecting past study data (review mode)	104
6-19: STI-PA setup screen	92	7-6: Viewing past data example	104
6-20: Level set-up and average decibel level	93	7-7: Loading and deleting files	105
6-21: STI-PA measurement (scale results) screen ..	94	7-8: Examples of directory screens	106
6-23: STI-PA Modulation envelope screen	96	7-9: Naming a file in the Data File screen	107
6-26: Captured curves/background noise	98	7-10: Saving/Creating setup file (config. file).....	108
6-27: Post CAP-1 applied during STI-PA test.....	98	7-11: Viewing, loading, deleting setup files	109
7-1: File Screen.....	102	A-1: Pinout for the AC/DC output jack	124
7-2: Start menu screen	102	A-2: Auxiliary connector	125

TABLES

1-1: Acoustical range bands	4	5-3: Measurement screens explained	59
2-1: Keypad explained	17	5-4: Measurement icons and screen descriptors explained	61
2-2: Screen Indicators	18	6-1: Reverb time set-up options	72
3-1: Required microphone settings.....	19	6-2: Tabular RT60 field explanation	78
3-2: Measures screen explained	25	6-3: Measures setup screen parameters explained	91
4-1: Level triggered auto-on settings explained.....	40	8-1: AC output.....	113
5-1: Measurement notations.....	51		
5-2: Sessions and studies explained	53		

(This page intentionally left blank)

Introduction

The SoundPro SE and DL series of Sound Level Meters (SLM) from TSI are advanced instruments with highly adaptable characteristics. This manual explains the features and functions of all models in the series and points out distinctions between the models.

Models and options

There are twelve models in the SoundPro SE and DL series meters. The differences between models are accounted for by three primary characteristics: accuracy of measurement, frequency resolution, and the types of data stored. The table in Figure 1-1 summarizes the characteristics of all twelve models and includes add-on features for Reverberation, Speech Intelligibility and Acoustic Spectral Curves.

Part #	Model	Class/Type 2	Class/Type 1	Summary and Statistical Data	Time History Data	1/1 Octave RTA	1/3 Octave RTA
SP-SE-2	SoundPro SE SLM	X		X			
SP-SE-2-1/1	SoundPro SE 1/1 Octave RTA	X		X		X	
SP-SE-2-1/3	SoundPro SE 1/1 & 1/3 Octave RTA			X			
SP-SE-1	SoundPro SE Sound Level Meter		X	X			
SP-SE-1- 1/1	SoundPro SE 1/1 Octave RTA		X	X		X	
SP-SE-1-1/3	SoundPro SE 1/1 & 1/3 Octave RTA		X	X		X	X
SP-DL-2	SoundPro DL Datalogging SLM	X		X	X		
SP-DL-2 – 1/1	SoundPro DL 1/1 Octave Datalogging RTA			X			
SP-DL-2 – 1/3	SoundPro DL 1/1 & 1/3 Octave Datalogging RTA	X		X	X	X	X
SP-DL-1	SoundPro DL Datalogging SLM		X	X	X		
SP-DL-1 – 1/1	SoundPro DL 1/1 Datalogging RTA		X	X	X	X	
SP-DL-1 – 1/3	SoundPro DL 1/1 & 1/3 Octave Datalogging RTA		X	X	X	X	X

Part #	Description	Compatible with the following models:			
Option-1	Speech Intelligibility (STI-PA) and Acoustic Spectral Curves	SP-SE-2-1/1 SP-SE-2-1/3	SP-SE-1-1/1 SP-SE-1-1/3	SP-DL-2-1/1 SP-DL-2-1/3	SP-DL-1-1/1 SP-DL-1-1/3
Option-2	Speech Intelligibility (STI-PA) with accessories and Acoustic Spectral Curves	SP-SE-2-1/1 SP-SE-2-1/3	SP-SE-1-1/1 SP-SE-1-1/3	SP-DL-2-1/1 SP-DL-2-1/3	SP-DL-1-1/1 SP-DL-1-1/3
Reverberation	Reverberation measurement and RT60 analysis (part number: 053-768)	(SoundPro SE and DL models with 1/1 and/ or 1/3 only) includes:			
		SP-SE-2-1/1 SP-SE-2-1/3	SP-SE-1-1/1 SP-SE-1-1/3	SP-DL-2-1/1 SP-DL-2-1/3	SP-DL-1-1/1 SP-DL-1-1/3

Figure 1-1: SoundPro Models SE and DL and Option 1 and Option 2

Frequency resolution

The sounds we hear are rarely pure tones at a single frequency but rather a mixture of frequencies of varying amplitudes. Some sounds, such as a whistle or a horn, have frequencies concentrated in relatively narrow regions of the audio spectrum, which ranges from approximately 20 Hz to 20,000 Hz. Other sounds, more generally thought of as noise, include components from many regions of the entire spectrum. When analyzing sound as noise, we usually are concerned with the total impact of the sound signal. In other words, we are usually satisfied with a broadband measurement of sound in the environment. When we are seeking to isolate a sound from other sounds, for instance to detect the source of a sound or to measure how much particular sounds contribute to the overall sound level, we may want to look at the frequency components of the sound.

Octave bands

The ability of an instrument to separate a signal into its frequency components is known as a spectral analysis. In sound pressure measurement, the audio spectrum is divided into adjacent frequency bands called octaves, where the center frequency of each octave band is twice the center frequency of the octave band directly below it. There are eleven octave bands in the audio spectrum.

Figure 1-2 illustrates the relationship between the bandwidth of a typical sound measuring instrument and the octave bands that span the audio spectrum. Note that the highest and lowest octaves at 16 Hz and 16 kHz lie entirely within the bandwidth of the instrument.

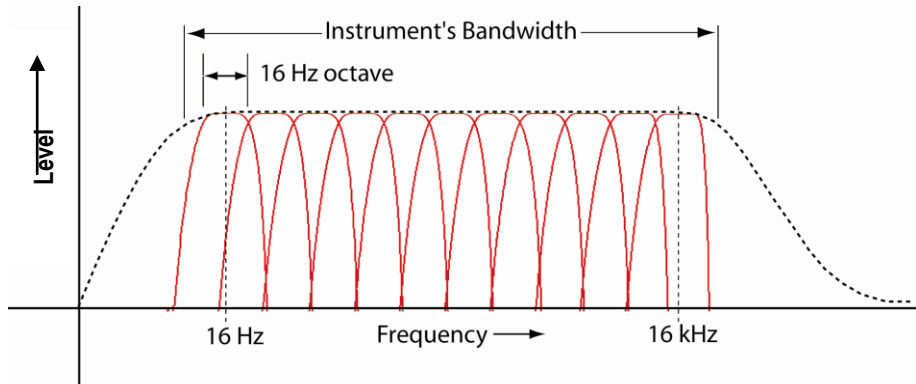

Figure 1-2: Octave bands

Third-octave bands

Each octave band can be divided into three adjacent bands called third-octave band. Because of the logarithmic relationship between adjacent bands, the center frequencies of third-octave bands differ from each other by 26%. For example, the center frequency of the next third-octave band above the 1000 Hz third-octave band is at 1260 Hz. Figure 1-3 is similar to Figure 1-2 but shows the thirty-three third-octave bands in relation to the instrument's bandwidth.

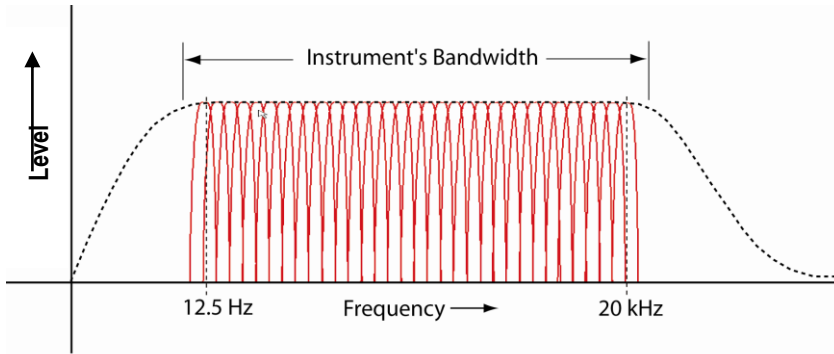

Figure 1-3: Third Octave bands

Naming bands

Bands are conventionally named for their center frequencies in accordance with acoustical industry standards. Table 1-1 (see below) identifies the SoundPro SE or DL models that have octave and third-octave bands option with their exact center frequencies and their corresponding standardized names.

Exact Center Frequency (Hz)	Names of Octave Bands (Hz)	Names of Third-octave Bands (Hz)
12.589		12.5
15.849	16	16
19.953		20
25.119		25
31.623	31.5	31.5
39.811		40
50.119		50
63.096	63	63
79.433		80
100.00		100
125.89	125	125
158.49		160

Exact Center Frequency (Hz)	Names of Octave Bands (Hz)	Names of Third-octave Bands (Hz)
199.53		200
251.19	250	250
316.23		315
398.11		400
501.19	500	500
630.96		630
794.33		800
1000.0	1000	1000
1258.9		1250
1584.9		1600
1995.3	2000	2000
2511.9		2500
3162.3		3150
3981.1	4000	4000
5011.9		5000
6309.6		6300
7943.3	8000	8000
10000		10000
12589		12500
15849	16000	16000
19953		20000

Table 1-1: Acoustical range bands

Analysis type

All SoundPro SE/DL instruments are capable of analyzing sound signals over the full bandwidth of the instrument also referred to as “broadband measurement.” If your instrument comes equipped with a filter, it can perform an octave or a third-octave analysis, or both, depending upon the type of filter installed. You can vary the analysis type between sessions, and the analysis type selection remains constant throughout the session.

Analysis types are identified in SoundPro SE/DL Sound Level Meter by the following names:

- **SLM** - Broadband measurements
- **1/1** - Octave filtering
- **1/3** - Third-octave filtering
- **STI-PA** -Speech Intelligibility

Logging explained

Although you can view the current sound pressure level at any time that the instrument is operating (See “Bar Chart and Filtered Bar Chart”), most measurements are reported for data obtained over the entire course of a study or session. In some circumstances; however, you may want to save intermediate measurement results. The SoundPro DL meter logging option provides you with that capability.

With logging enabled, you can save selected measurements at fixed intervals during a session. You can set logging to occur as often as once per second or as seldom as once per hour. Once the logging characteristics are determined, the setup remains the same for the duration of the session.

Logged data is automatically saved to the instrument’s memory card and can be viewed in QSP II (“Information screen”).

- ☑ **NOTE:** You must use a compatible SD card. For information about replacing the SD card, see “Compatibility.”

Physical Characteristics

The Display

The transfective LCD display contains an area on the top of the screen for indicators including run, pause, stop icons and a run time clock. The middle of the screen contains a fine resolution of pixels in which data is displayed both numerically and graphically. This is explained in further detail in Chapter 2, “The Display and keypad”).

Hardware interfaces

The Hardware Interface Panel, shown in Figure 1-4, is located under a hinged cover in the base of the instrument. The cover can be lifted by a tab at one side, and snapped shut again by closing and pressing firmly at the center.

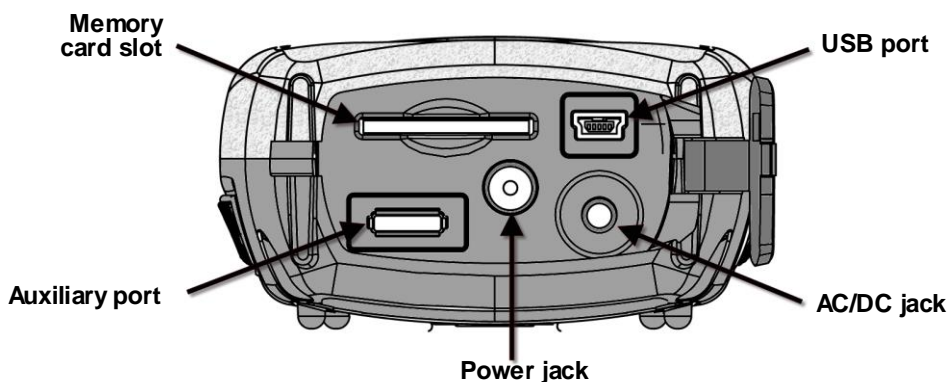

Figure 1-4: Hardware Interface Panel

Memory card slot

A Secure Digital (SD) removable memory card is shipped with each SoundPro SE/DL instrument. The card should always be in place when you are operating the instrument. More information about operating with the memory card can be found under “Memory card.”

- NOTE:** You must use a compatible SD card. For information about replacing the SD card, see “Compatibility.”

USB port

Each SoundPro SE/DL instrument ships with a USB cable. One end fits the mini B port in the instrument. The other end fits a standard USB connector on a personal computer. A USB connection to a personal computer allows files to be transferred, settings to be downloaded to the instrument, and post-session analysis to be performed in the computer using data files created in the instrument.

AC/DC port

Connect a cable with a standard 3.5-mm stereo plug to this jack to obtain AC and DC output signals. Users are responsible for providing their own cable.

Power jack

DC power can be delivered to the instrument through the Power jack. Power will be taken from the external source rather than the instrument’s batteries when the external source provides 8 to 16 volts DC (300 mA minimum).

Two optional sources for this power are available: a switching power supply connected to an AC source and DC power provided through the accessory jack of most automobiles. For the technical specifications, see “Power sources” in Appendix A. Part numbers are given under “Optional parts” in Appendix A.

Auxiliary port

Use this port to connect the SoundPro SE/DL instrument to other devices. The two types of functions, described below, are available through the terminals of this port. A pinout of the port is provided under “Auxiliary connector.”

- **Digital I/O** - A group of contacts within the port provides one, logic-level input and three, logic-level outputs. See “Digital Outputs/Triggering” for information about configuring and using the triggers.
- **RS-232** - A group of contacts within the port supports the RS-232 protocol for communication between the instrument and other devices, such as a Global Positioning Satellite (GPS) receiver. See “GPS” for information about configuring the port for this purpose.

Information screen

Every SoundPro SE/DL instrument describes its unique characteristics in its Information screen. In the Start screen, press ▲/▼ to select **Unit Info** then press . The Unit Info screen appears (Figure 1-5).

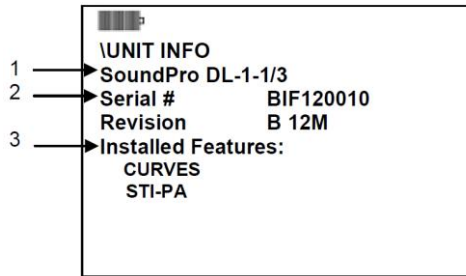

Figure 1-5: The Unit Information screen

Screen contents

The lines indicated in Figure 1-7 will contain the following information.

- Line 1** Model number showing, in order, the TSI designation (SE or DL), the Class/Type (1 or 2) and the filter, if installed (1/1, 1/3 or blank).
- Line 2** Unique serial number assigned when the instrument was manufactured.
- Line 3** The installed feature's field lists any extra options (**Note:** These may be additionally purchased features as displayed above for Curves and STI-PA.)

NOTE: It is worthwhile to record Information screen data in the event that you need assistance and the instrument refuses to power up. For TSI assistance, see "Contacting TSI."

Detection Management Software DMS

TSI Detection Management Software DMS is used to record, report, chart and analyze data collected for assessment of select occupational health hazards in the workplace. Designed for dosimetry, sound level measurements, heat stress assessments and environmental monitoring, the software helps safety and occupational professionals:

- Retrieve, download, share and save instrument data
- Generate insightful charts and reports
- Export and share recorded data
- Perform "What If" analysis and recalculate data based on selected time intervals
- Set up instruments and check for firmware updates

Some data can only be displayed in DMS. One example is logging data obtained when logging is enabled in an instrument equipped with that option ("Logging"). Another example is with the GPS function. When enabled the data is viewable in DMS.

DMS Start Page

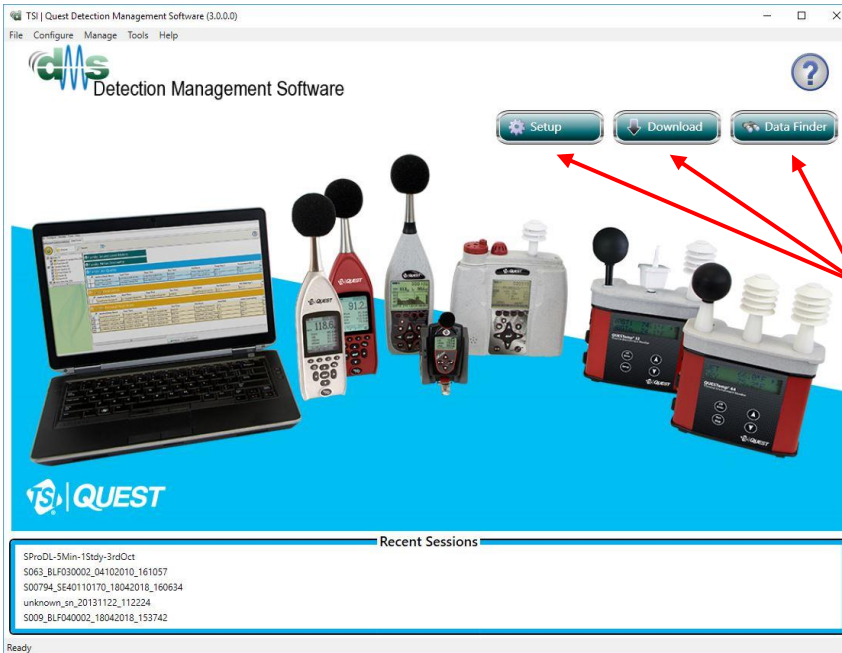

Navigational buttons

- (1) Setup
- (2) Download
- (3) Data Finder
(look at your session data or use Quick Report feature)

Getting Started

This chapter provides the basic information you need to “get up and go” essentially right out of the box, including getting your first glimpses of SPL.

Checking the equipment

If you received your instrument in a storage case, remove all the packaging and acquaint yourself with the equipment, so you can quickly get started. The items below are included in a “standard” SoundPro SE or DL kit.



Figure 2-1: Identify SoundPro equipment

Installing the preamp

The preamplifier is detachable for storage purposes or if you want to connect an extension cable for distance monitoring.

➤ **Connecting to the instrument**

Place the preamp connector over the mating connector at the top of the instrument. Gently press down while rotating the preamp until the preamp connector drops slightly in place.



Figure 2-2: SoundPro & Preamp

1. While pressing the connector together to engage the threads, rotate the black knob clockwise to secure the preamp to the instrument. It will fit snugly.

➤ **Connecting an extension cable**

Extension cables are available from TSI as options and are typically used to distance the instrument body from the microphone to reduce distorting reflections from the instrument's case.

1. Attach the cable to the base as if it were the preamp and then follow the steps above "Connecting to the instrument." Attach the preamp to the other end of the cable.

Microphone and accessories

The instrument is ordered either for Class/Type 1 or Class/Type 2 use. See "Distinctions between models" for information about this classification. The microphones are treated differently for the two classes of instruments.

Class/Type 1 and Class/Type 2 instrument

The SoundPro Sound Level Meter is shipped with the Type 1 in a protective case with a serial number labeled on the side of the microphone. Similarly, the SoundPro instrument with the Class/Type 2 microphone is also shipped in a protective case. To attach and remove the microphone, please follow one of the types below:

- **BK4936 microphone** - Remove the microphone from its case and thread it on the SoundPro SE/DL preamp in accordance with the instructions provided in the microphone case. *Note that the BK4936 microphone is provided with a Random Incidence Corrector (RIC). Use the same microphone instructions for information about using and installing that device.*
- **All other Class/Type 1 microphones** - Remove the microphone from its protective case and thread it on the preamp. Before using, be sure to remove the plastic cap and save it in the case for future use.
- **Class/Type 2 microphones** – Remove the microphone from its protective case and thread it on the preamp. Before using, be sure to remove plastic cap and save it in the case for future use.



- NOTE:** To properly remove the microphone, please adhere to the caution sticker located on the backside of the instrument and the drawing to the right.

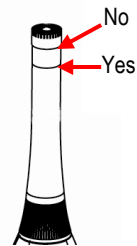

Windscreen

Use a windscreen that fits the tip of the microphone to reduce sound disturbances caused by physical contact and wind turbulence. TSI provides the WS-7 windscreen that fits a 1/2-inch microphone with every instrument kit. If you did not order a 1/2-inch microphone, or if you have one of different size, you may want to order a windscreen for the other size.



Figure 2-3: SoundPro with microphone and windscreen

Providing power

The instrument can be powered with internal batteries or from an external power source. There are two optional sources which include a universal power supply 9V/66A 2.1 mm and an auto DC jack cable 12V. (See Optional Parts, in Appendix A for more details.)

Installing Batteries

The instrument requires four AA-sized batteries. Disposable alkaline batteries are satisfactory, but you may also use rechargeable Nickel Metal Hydride (NiMH) batteries.

- **Rechargeable batteries** ~ The instrument does not contain a recharging circuit. Recharge batteries externally using the recharging device available from TSI or a compatible device available elsewhere.
- **Selecting batteries** ~ **DO NOT** mix battery types or batteries with significantly different charge levels.
 - ☑ **NOTE:** To avoid possible battery leakage, remove the batteries when the meter is not in use for prolonged periods.

➤ To install batteries

1. With the back of the instrument facing up, push the release latch to pop open the battery lid (Figure 2-1).

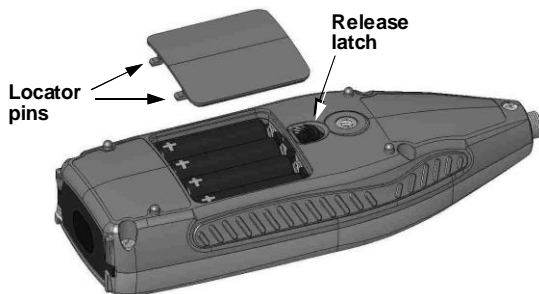

Figure 2-4: Installing batteries

2. Lift off the lid and set aside. Wedge out the four batteries.
3. Replace the batteries with fresh batteries, taking care that you orient all batteries with the positive ends toward the base, as shown in the drawing.
4. Re-insert the lid by fitting its locator pins into slots in the base end of the battery compartment. The lid should fit snugly when correctly inserted.
5. Press the top edge of the lid to snap it into the latch.
6. Verify or set the type in the **Battery Check** screen. (See the next section “Checking battery power.”)

Battery power explained

The battery check screen is used to determine the battery/power status of the instrument. When operating on batteries, the grey area in each cell graphic indicates the charge on each cell (Figure 2-5).

When operating on an external power source (see next section, “external power sources”), the external power will take precedence over batteries if installed.

Battery indicator

If all bars appear up to starting line, this indicates full battery power

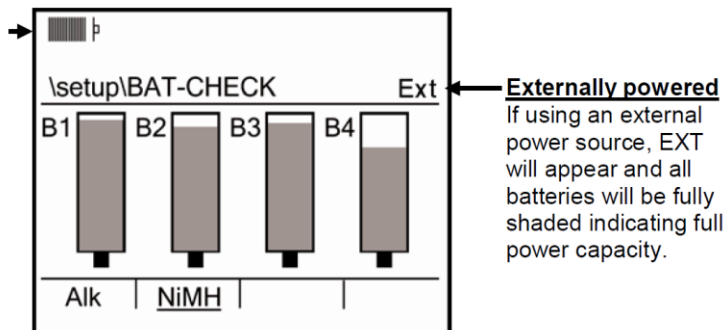



Figure 2-5: Battery check screen

Checking or changing type

The battery type selection in this display affects the accuracy of the Battery Indicator that appears in many SoundPro SE/DL meter displays.

- ☑ **NOTE:** It is recommended to match the battery type to the type of batteries installed in the instrument, or you may experience an unexpected shutdown.

➤ Battery Check screen

- Turn on the SoundPro SE/DL by pressing **On/Off/ESC** . You will be at the start screen.
 - If turned on, ensure you are at the start screen by pressing **On/Off/ESC**  repeatedly until the start screen appears.

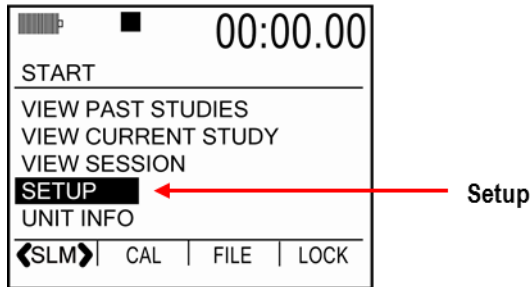





Figure 2-6: Selecting Setup in the Start Screen

- Press **Up/Down** / arrows to highlight **Setup** and then press **Enter** .
- In the Setup screen, select **Battery**, then press **Enter** . The **Battery Check** screen appears.

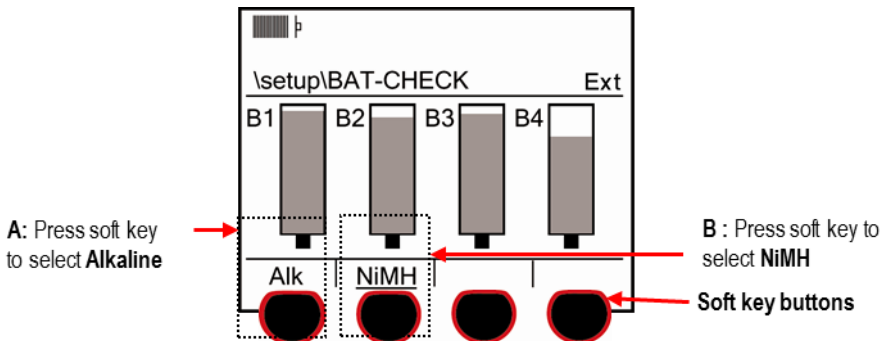



Figure 2-7: Selecting battery type in battery check screen

- Press the soft key that corresponds with the installed battery type (See “A” or “B” in Figure 2-7 for selection). The label above the soft key is underlined to indicate the current selection.
- When completed, press **On/Off/ESC**  once to return to the Setup screen and twice to return to the start screen.

Using power supply or auto adapter

If you obtained the optional Universal power supply 9V cable or the Auto DC Jack 12 VDC adapter from TSI, plug them into their respective power sources and the other end into the Power jack of the instrument. If the external power source provides the correct voltage (8-16 VDC) and sufficient current (300 mA minimum), it will be used in place of the batteries if they are installed in the instrument.



Figure 2-8 illustrates the assembly of the Universal power supply and the plug adapter. It slides into place by guiding it down the back cavity (opening) of the power supply.

- ☑ **NOTE:** The example is a typical adapter which may be different than the one you are using. Mechanically, it will function similarly.

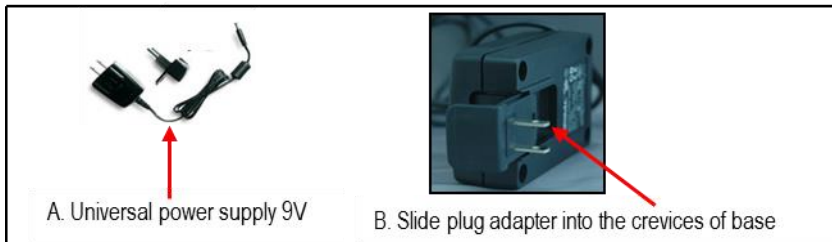

Figure 2-8: Attaching the charger adapter with the plug adapter

➤ Connecting power supply source

1. Ensure the power supply is assembled (for universal power supply only).
2. Plug the power cord into the power jack by opening the base cover. Attach the opposite end into the power supply (i.e., outlet/automobile jack) (as discussed in "Hardware interfaces.")

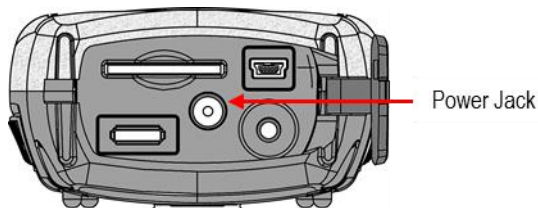



Figure 2-9: Base (or bottom) of SoundPro

3. Plug the opposite end into the power supply.

Turning on

1. To turn on the SoundPro meter, press the **On/Off/Esc**  key until the start screen appears.

Start screen and the keypad

The Start screen is the first screen you see when you power on and the last screen you see when you shut down. This essential main screen is also used to navigate through the menu options.

The keypad and soft keys are used to setup the instrument, run a study, stop a study, view your measurement values, and power on and off the meter.

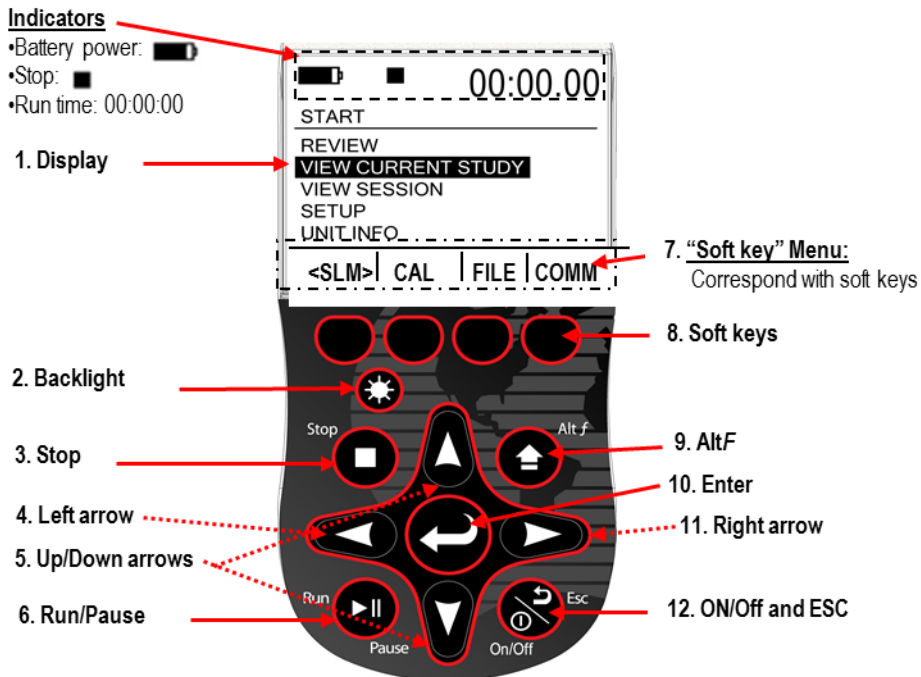

Figure 2-10: SoundPro SE/DL start screen and keypad

SoundPro functionality

The keypad explained

The SoundPro SE/DL keypad consists of three general types of keys: soft keys, navigation keys and dedicated keys.

Keypad	Explanation
1. Display	Used to view data, menus, and various indicators.
2. Backlight	Used to illuminate the background of the display/screen. (i.e., nighttime study.)
3. Stop	Used to stop your study when in the Run or Pause modes. A 3,2,1 countdown will appear as you continue to press the stop button.
4. Left arrow	Used to navigate left through menus and/or data.
5. Up/Down Arrows	Used to navigate through menus and/or data.
6. Run/Pause	Used to Run or Pause a study. (A run or pause indicator will appear at the top of the screen to signal you of the appropriate mode.)
7. Soft key menu	The soft key menu are additional menu options for setting measurement type (i.e, SLM, 1/1, etc.), Calibrating, Loading a study file, setting Lock/secure settings, and many more options.
8. Soft keys	The soft key buttons correspond with the soft key menu. (Please see Figure 2-10 above).
9. AltF	The AltF button (or Alternate functions) is used to expand the soft key menu at times.
10. Enter	Used frequently to execute an action. Typically used after you have first pressed one or more arrow keys to make a selection.
11. Right arrow	Used to navigate right through menus and/or data.
12. On/Off and ESC	Used to turn on the SoundPro meter, turn off, and to Escape (or move back one screen).

Table 2-1: Keypad Explained

Indicators explained

Status information is provided by the instrument at the top of the display. Below is a summary of all of the indicators.







Icon	Significance
	Battery charge status. This icon shows the status/level of the batteries. A full battery indicates one of the following: <ul style="list-style-type: none"> externally powered or the SoundPro meter is fully charged.
	Run state. This icon appears when a study is running.
	Paused state. This icon appears when the current session is open but paused.
	Stop state. This icon appears when the current session is stopped.
	Review mode. When the pause and stop icons appear, this indicates that you are viewing a saved file.
OL	Overload condition. When an overload occurs during a study, this indicator appears and remains lit until the beginning of the next study.
UR	Underrange condition. When an underrange condition occurs during a study, this indicator appears and remains lit until the beginning of the next study.
	Alternate functions. This icon appears below the Battery Charge Indicator when alternate functions are being displayed.

Table 2-2: Screen Indicators

Navigating

To navigate to menus and data screens, the **up/down ▲/▼ arrows** and **left/right arrows ◀/▶** are primarily used.

The **On/Off Esc**  button is also used as a navigational tool at any time you want to move back one level. If you press **ESC** repeatedly, you will return to the start screen.



Turning off

- To turn off the SoundPro, ensure the meter is stopped (i.e., ■ indicator will display on the top of the screen).
- Press and hold the On/Off/ESC  button until the start screen disappears.

Basic setups

This chapter covers the basic features and setups of SoundPro® SE/DL Sound Level Meter that establish the instrument's operating conditions. For information about the more advanced SoundPro SE/DL meter features and their setups, see Chapter 4, "Advanced setups." For information on setting-up and measuring add-on features (Reverberation, STI-PA, or Curves), please see Chapter 6.

- Microphone Settings
- Setting Date-Time
- Setting Measurement type (SLM, 1/1, 1/3, STI-PA)
- Setting up Meter 1/Meter 2 parameters
- Setting up Exceedance levels
- Setting up Logging
- Setting physical settings: backlight "on" time, contrast, choosing a language
- Microphone settings

With Class/Type 1 models, the microphone's sensitivity, range cap, and polarization can be checked and/or changed in the "**Signal Input**" menu (when stopped). Alternatively, Class/Type 2 models settings are viewable at any time the session is stopped but cannot be modified.

The following table displays the required microphone settings.







Signal Input	BK4936	QE7052	QE4110	QE4130	QE4150	QE4170
Sensitivity ^a	-28.0	-29.0	-49.1	-36.0	-26.0	-28.0
Range Cap (dB)	140	140	160	140	140	140
Polarization (V)	0	0	200	200	200	200

Table 3-1: Required microphone settings

Changing microphone settings

➤ Microphone settings

This procedure applies only to Class/Type 1 models.

1. Turn on the SoundPro SE/DL meter by pressing **On/Off/Esc** .
 - If turned on, ensure you are at the start screen by pressing **On/Off/Esc**  repeatedly until you return to start screen (see Figure 2-10).
2. Press **Up/Down**  /  arrows to highlight **Setup** and then press **Enter** .
3. In the Setup screen, select **Sig. Input**, then press **Enter** . The Signal Input screen appears.

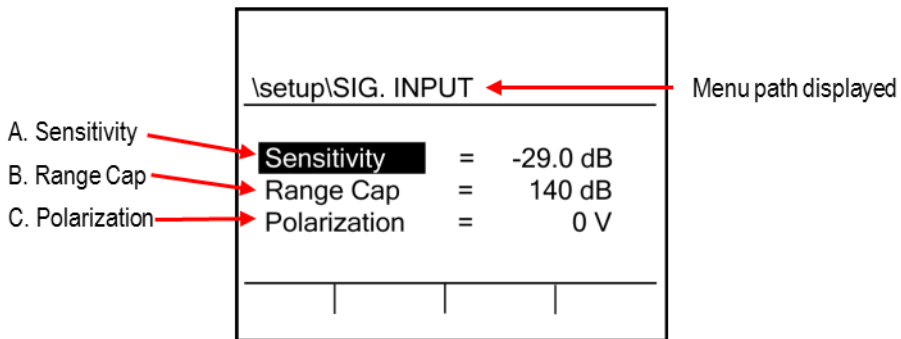





















Figure 3-1: Microphone Settings (Signal Input screen)

4. Signal Input **options** are explained below (refer to Figure 3-1 above).
 - A. **Sensitivity** ~ Calibration parameter for the selected microphone. This is a nominal value in decibels relevant to 1V/Pa.
 - B. **Range Cap** ~ Top of the measurement range for the microphone/ instrument combination. In any screen showing a decibel range, this setting affects the maximum value.
 - C. **Polarization** ~ A value of the polarization voltage for the microphone. Some microphones have an internal polarization, while others require a polarization provided by the instrument.
5. To change a signal input field, press **Up/Down**  /  arrows to highlight specific field(s).
6. Press **Enter** . The result will be one of the following:
 - **For Sensitivity and Range Cap** fields - The highlighting **moves** to the data field. Press **Up/Down**  /  arrows to change the value.
 - **Polarization** field - Polarization remains highlighted. Continue to press **Enter**  to change (or toggle) the value from 0 V to 200 V.
7. Once desired fields are changed, press **On/Off/ Esc**  twice to return to the Start screen.

Time and date

SoundPro SE/DL meter uses a 24-hour clock and specifies date by month and year.

➤ Changing time and date settings

1. Turn on the SoundPro SE/DL meter by pressing **On/Off/Esc** .
 - If turned on, ensure you are at the start screen by pressing **On/Off/esc**  repeatedly until you return to start screen (see Figure 2-10).
2. Press **Up/Down**  to highlight **Setup** and then press **Enter** .
3. In the Setup screen, select **Time-Date**, then press **Enter** .
4. In the Time-Date screen, press  to select either the **Time**, **Date**, **Day** fields. Then do one of the following:
 - a. For **Time** field, press **Enter**  repeatedly to highlight either the hour, minutes, or seconds. Next, press **Up/Down**  to change the value.
 - b. For **Date** field, press **Enter**  repeatedly to highlight either day, month, or year. Next, press **Up/Down**  to change the value.
 - c. For **Day** field, press **Enter**  repeatedly to highlight either day, month, or year. Next, press **Up/Down**  to change the value.

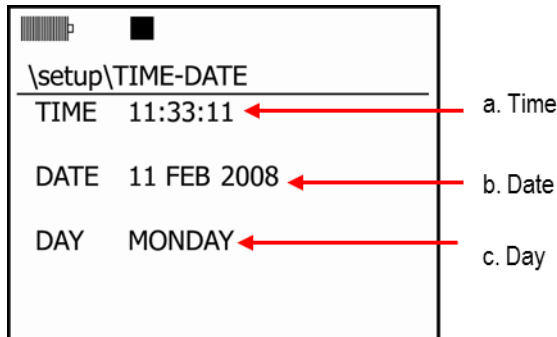



Figure 3-2: Time and Date Settings

NOTE: To move to between the time, day, day fields, press **Enter** repeatedly until one of these fields are highlighted and then press **Up/Down** arrow to move between the fields.



5. If you are finished working in the Time-Date screen, press **On/Off/Esc**  once to return to the Setup screen and twice to return to the Start screen.

Measurement type (SLM, 1/1, 1/3, STI-PA, RT60)

The measurement type is easily selectable at the start screen via a soft key button. This is assessable at all times unless you are running a study. To change or set the measurement type, ensure the SoundPro meter is stopped as indicated by the stop ■ icon. Depending on the options you ordered with your SoundPro meter it may or may not have all the measurement types indicated above.

☑ **NOTE:** For STI-PA and RT60, please see Chapter 6, “Additional Options.”

➤ Setting Measurement type

1. Turn on the SoundPro SE/DL meter by pressing **On/Off/Esc** .
 - If turned on and you are not at the start screen, press **On/Off/Esc**  repeatedly until the start screen appears (see Figure 3-3).
2. At the start screen, select the **first soft key button** repeatedly until the appropriate **measurement type** is selected.
 - You may have the following selectable options: Sound level meter (SLM), 1/1 octave, 1/3 octave, and/or STI-PA (Speech Transmission Index).

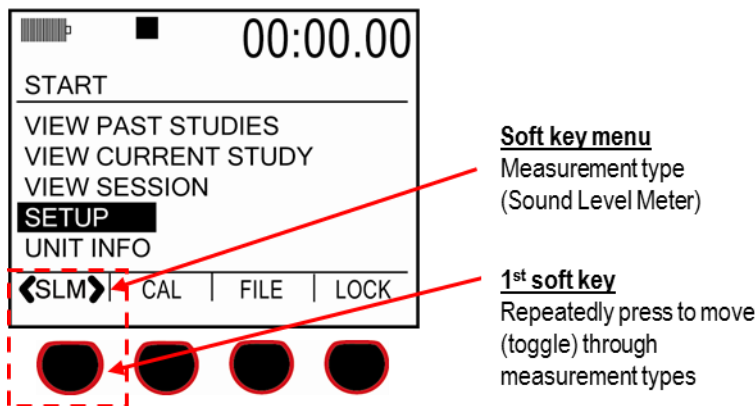









Figure 3-3: Measurement type and start screen

Meter 1/Meter 2 Parameters (i.e. response time, weighting)

Setting up Meter 1 and Meter 2 parameter settings are changed through the soft keys and the Measure Set screen of the SoundPro Sound Level Meter.

➤ Setting up Meter 1 and/or Meter 2 parameters

1. Ensure you are at the start screen.
 - If turned on, press **On/Off/Esc**  repeatedly until you return to the start screen (see Figure 3-3).
2. Press **Up/Down**  to highlight **Setup** and then press **Enter** .
3. Select **Meter Set** by pressing **Up/Down**  to highlight and then press **Enter** .
4. To set the **response time** for Meter 1, press the second soft key repeatedly until the either **Fast (F)**, **Slow (S)**, or **Impulse (I)** is selected.
 - An underline denotes which feature is selected.
5. To set the **weighting** for Meter 1, press the third soft key repeatedly until either **A**, **C**, **Z**, or **F** is underlined (or selected).
 - To set **Meter 2** response time and weighting, press 4th soft key until Meter 2 is selected. Then repeat steps 4 & 5.
6. To change the Meter parameters, press **Up/Down**  to select one of the Meter Set fields.
7. To change any of the values, press **Enter**  to move to the data fields.
 - Continue to press **Enter**  until the specified setting is selected. Press the **Left** arrow to return to the Meter Set fields.

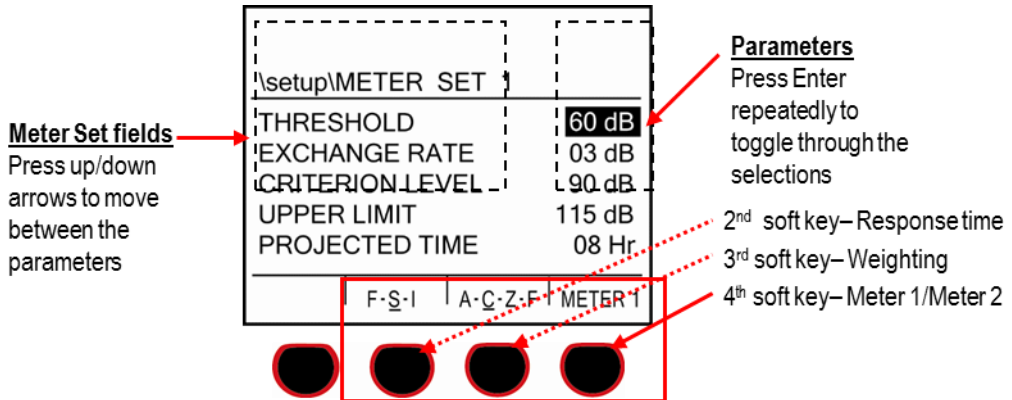







Figure 3-4: Meter 1 and Meter 2 parameters

- ☑ **NOTE:** For quick and easy access, there are three optional screens to change the timed response and the weighting. These are in the following SoundPro screens: Measures Set screen, View Current Study screen, and View Session study screen.

Measurement setup (for community noise)

The measure screen is used to select community noise settings for meter 1 only. Table 3-2 below explains the settings and options.

➤ **Setting up community noise measurements** (refer to figure 3-5 below)

1. Ensure you are at the start screen.
 - If turned on, repeatedly press **On/Off/Esc**  until you return to the start screen (see Figure 3-3).
2. Press **Up/Down**  to highlight **Setup** and then press **Enter** .
3. Select **Measures** from the Setup screen by pressing **Up/Down**  to highlight and then press **Enter** .
4. In the **Measures** screen, press **Up/Down**  to select one of the measurements. To select second column, first press **Up/Down** arrows then press **Right** arrow.

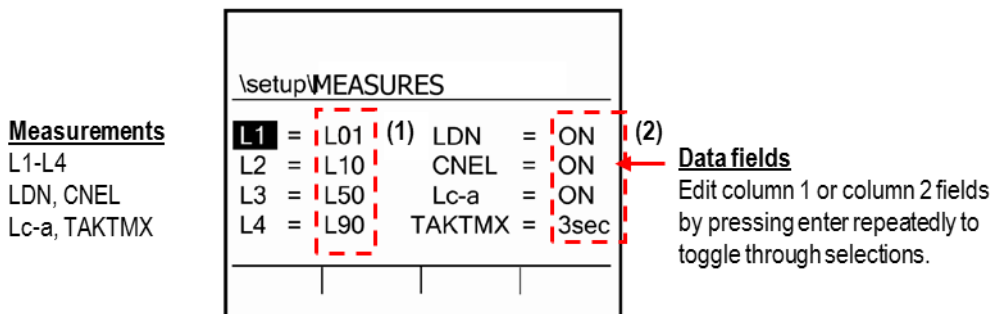









Figure 3-5: Measures screen for community noise settings

5. To make changes to the data fields, do one of the following:
 - **L1-L4** - Press **Enter**  to move to the data field. In the data field, repeatedly press **Enter**  to change your selection.
 - Press **▲/▼** arrows to change percentage.
 - **LDN** - Press **Enter**  to move to data field and continue to press **Enter**  to toggle between On/Off setting.
 - **CNEL** - Press **Enter**  to select data field. Press **Enter**  repeatedly to toggle between On/Off setting.
 - **Lc-a** - Press **Enter**  to select data field. If marked "N/A," see "C-A measurement settings."
 - **TAKTMX** - Press **Enter**  one or more times to select 3 sec., 5 sec., or Off.
6. To change other measurement settings, repeat steps 4–5.

7. When finished, press **On/Off/Esc**  to exit the screen.

The following table explains your selections in the Measures screen (Please see Appendix B, Glossary of Terms for more details.)

Measurements	Explanation
L1-L4 (Exceedance)	L1-L4 are types of exceedance levels. This is defined as the level exceeded by the measured noise level for an identified fraction of time. Exceedance levels may be calculated for many time fractions (or percentages). <ul style="list-style-type: none"> Optional Settings: Set to "Off" or to a percentage value of your choice (1-99%).
LDN	Representing the Day/Night sound level, this measurement is 24-hour average sound level where 10 dB is added to all of the readings that occur between 10pm to 7am. (Please see glossary of terms for more details). <ul style="list-style-type: none"> Optional Settings: Set to "Off" or "On."
CNEL	Community Noise Exposure Level. The accumulated exposure to sound measured in 24-hour sampling interval and artificially boosted during certain hours. <ul style="list-style-type: none"> Optional Settings: Set to "Off" or "On."
L_{c-a}	This measurement (also commonly called C-A measurement) is only available under certain conditions. Information about viewing and changing these meter settings is discussed under the next section, "C-A measurement settings." Optional Settings: Set to "On" and "Off." See C-A section below for parameter settings.
TAKTMX	A time average over a sampling that uses the highest level occurring during the preceding Taktrmaximal interval (either three or five seconds), and assumes it was present for the whole Taktrmx interval. <ul style="list-style-type: none"> Optional Settings: Set to "Off", "3sec", or "5sec"

Table 3-2: Measures screen explained

C-A measurement settings

The C-A measurement is determined from concurrent measurements of the SPL by both meters. It can only be made if certain settings for Meter 1 and Meter 2 are compatible. If any incompatibility exists, the Lc-a selection in this screen will be marked N/A (Not Available).

If you want to activate Lc-a, have the following settings in place before you visit the Measures screen.

- **Thresholds** - Both meters set to “Off” or the same value.
- **Exchange rates**- Both meters set to the same value.
- **Time response** - Both meters set to the same value.
- **Frequency weightings**- Meter 1 must be set to A-weighting; Meter 2 must be set to C-weighting.

Figure 3-6 is an example of the appropriate C-A settings for Meter 1 (left side) and Meter 2 (right side). (Please see “Meter 1/Meter 2 Parameters” for setup details.)

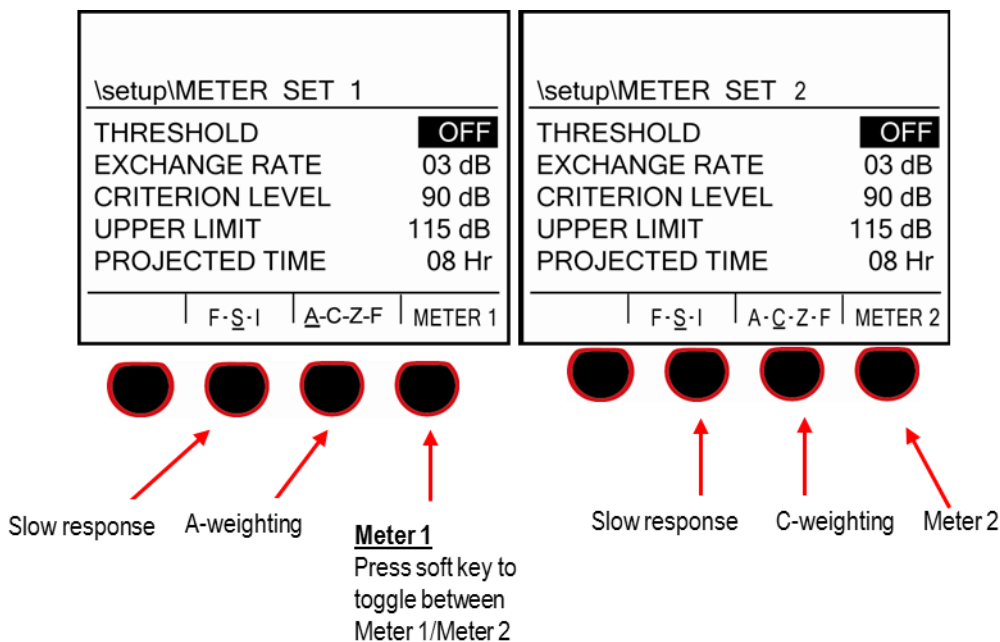

Figure 3-6: C-A measurement settings for Meter 1 and Meter 2

Logging

Logging options

If the logging option was purchased, you will have the following four types of measurement options:

- Average (AVG on the display), Peak, Maximum (MAX on the display), Minimum (MIN on the display).

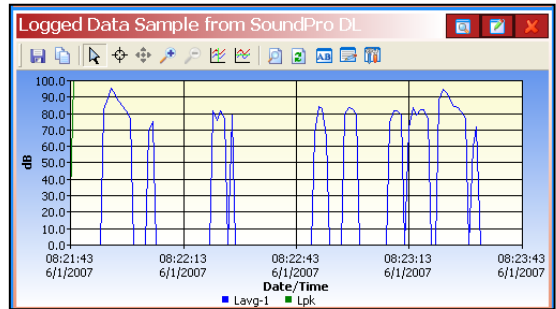

Figure 3-7: Logged Data Chart example

- ☑ **NOTE:** When logging is enabled and you are viewing these measurements on the SoundPro display, these are labeled as: L_avg (or L_eq if the exchange rate is set to 3 dB), L_Pk, L_Mx and L_Mn, respectively (See Chapter 5, “Preparing to measure and running.”)

Exceedance level

Up to two different exceedance level percentages, ranging from 1–99, can be set in the Meter 1 Logging screen when the logging interval is set to 1 minute.

- ☑ **NOTE:** If the logging interval field is not set to 1 minute, “N/A” (not available) will appear in the data field.

Filters

The filter option is either a “On” or “Off” setting in Meter 1 and is only available if the instrument contains a filter option.

- ☑ **NOTE:** The filter option must be set to “on” to data log filtered data.

Logging interval





The logging interval is the length of time between logging events.

- ☑ **NOTE:** The inverse of the logging interval is the logging rate.

Setting logging options

To set logging only options (Average, Peak, Maximum, and Minimum)

➤ Enabling or disabling logging options

1. Ensure you are at the start screen.
 - If turned on, repeatedly press **On/Off/Esc**  until you return to the start screen (see Figure 3-3 above).
 - To turn on, press and hold **On/Off/Esc**  until the start screen appears.
 2. Press **Up/Down ▲/▼** to highlight **Setup** and then press **Enter** .
 3. Select **Logging** by pressing **Up/Down ▲/▼** to highlight and then press **Enter** .
 4. To change the Logging options for Meter 1 do the following:
 - a. Press **Up/Down ▲/▼** to highlight either **AVG, PEAK, MAX, MIN**.
 - b. Once the measurement is selected, press **Enter**  button to toggle between “On” or “Off.” Press **right/left** arrow to move back to logging field.
- ☑ **NOTE:** If you are setting Meter 2 options, ensure you are on Meter 2 by pressing the Meter 1/ Meter 2 soft key, and then repeat step 4a-b.

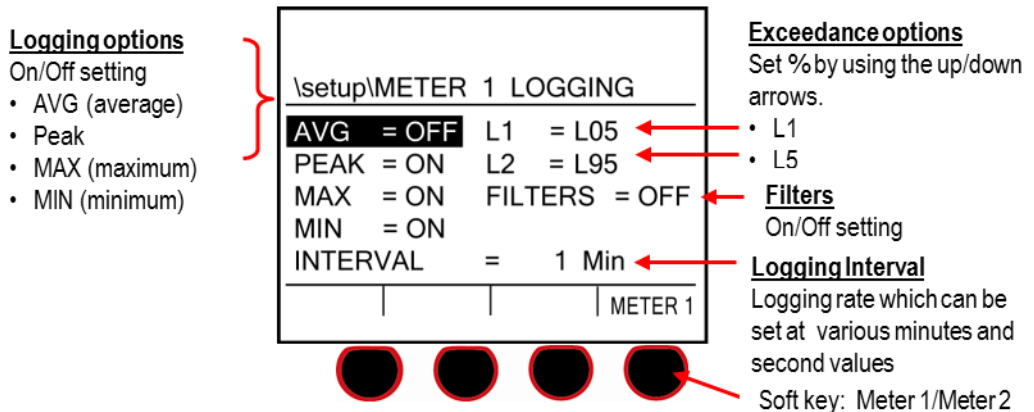















Figure 3-8: Logging screen explained

5. To change the **Exceedance Levels** on Meter 1, press **Up/Down ▲/▼** to select either L1 or L2.

6. Press **Enter**  to move to the data field. If it is Off and you want to set a percentage, press **Enter**  repeatedly until a percentage appears. To disable, repeatedly press **Enter**  until "Off" appears.
 - c. To change the percentage, repeatedly press **Up/Down**  /  to select a specific percentage.
 - d. Press right/left arrow to move back to **Exceedance level** field.
5. To change the **Filters** option, press **Up/Down**  /  to highlight "Filters" and then press **Enter** to toggle between "On" or "Off."
6. To change the **Logging Interval**, press **Up/Down**  /  to select "Interval."
 - a. Press **Enter**  to move to the data field (i.e., 1 minute). To change the value, repeatedly press **Up/Down**  /  until the appropriate minutes or seconds are displayed.
 - b. Press right/left arrow to move back to interval field.
7. To return to the Start screen, repeatedly press **On/Off/Esc**  button.

Setting up display options

The display's backlighting, contrast and language characteristics can be customized to suit your needs and preferences. These settings are available in the Display screen (Figure 3-9).

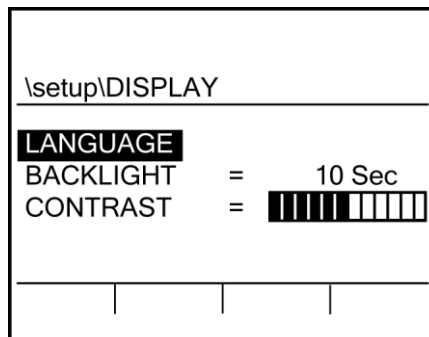









Figure 3-9: Display setup screen

Language

You can choose a different language for the displayed text. A change in language takes effect when you exit the Language screen.

➤ Changing the language

1. Ensure you are at the start screen.
 - If turned on, repeatedly press **On/Off/ESC**  until you return to the start screen (see Figure 3-3 above).
 - To turn on, press and hold **On/Off/ESC**  until the start screen appears.
2. Press **Up/Down** ▲ / ▼ to highlight **Setup** and then press **Enter** .
3. Select **Display** by pressing **Up/Down** ▲ / ▼ to highlight and then press **Enter** .
4. In the **Display** screen, ensure Language is highlighted (or press up/down arrow to select) and press **Enter** 
 - The Language screen appears. An asterisk (*) precedes the name of the currently selected language.
5. Press **Up/Down** ▲ / ▼ to select a language (an asterisk will appear if selected) and then press **Enter** .
6. **On/Off/ESC**  twice to return to the start screen. The new language will be displayed.

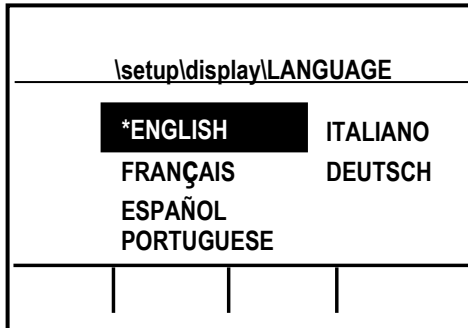
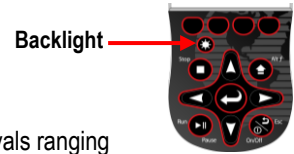

Figure 3-10: Language screen

Backlight

Typically, the SoundPro Sound Level Meter is shipped with the backlight setting enabled. With a quick press of the backlight button from the keypad, you can quickly turn on and turn off the backlight.



The backlight feature has an optional timed setting for various second intervals ranging from 1 second to 60 seconds. Once a timed setting is activated and you press the backlight button, the backlight will illuminate for the selected interval (i.e., 10 seconds) and then turn off.

- NOTE:** Backlighting consumes energy at an increased rate. Leaving it on while operating with batteries will decrease battery life by up to 10%.

➤ Setting or viewing Backlight options

1. From the start screen, press **Up/Down ▲ /▼** to highlight **Setup** and press **Enter ↵**.
2. In the **Setup** screen, press **Up/Down ▲ /▼** to highlight **Display** and press **Enter ↵**.
3. In the **Display** screen, press **Up/Down ▲ /▼** to highlight **Backlight**.
4. Press **Enter ↵** to move to the data field. Repeatedly press **Enter ↵** to toggle between “Manual” and “XX Sec” fields.
 - NOTE:** If you are not setting the timed backlight, skip step four.
5. To change the timed backlight, ensure you are on a timed value (i.e., 10 seconds) and repeatedly press **Up/Down ▲ /▼** to increase or decrease the time. Once set, press the **Left arrow**.

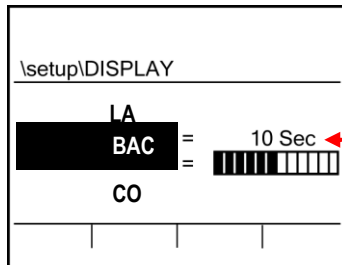



Figure 3-11: Backlight setting

Backlight settings

- **Manual** – The backlight is turned on and turned off by pressing the backlight button on the keypad.
- **Interval time** – repeatedly press Up/Down arrow to increase or decrease the seconds.



6. Press **On/Off/ESC**  twice to return to the start screen.
7. To set the backlight, press the backlight button on the keypad.

Contrast

The contrast adjustment affects all pixels in the LCD screen. Choose a level that looks best to you.

- ☑ **NOTE:** If the contrast level is set too high, icons and the RunTime clock in the Status Region of the display can be ghosted (visible in this display although they are not supposed to show). Reduce setting to avoid ghosting.

➤ Changing the contrast on the display

1. From the start screen, press **Up/Down ▲ /▼** to highlight **Setup** and press **Enter** .
2. In the **Setup** screen, press **Up/Down ▲ /▼** to highlight **Display** and press **Enter** .
3. Press **Up/Down ▲ /▼** to highlight **Contrast** and then press **Enter** .
4. Repeatedly press the left or right arrow to decrease or increase the contrast.

- ☑ **NOTE:** The contrast will change as you change the contrast color with the left or right arrows.

5. To exit the display screen, press the **On/Off/Esc**  twice to return to the Start screen.

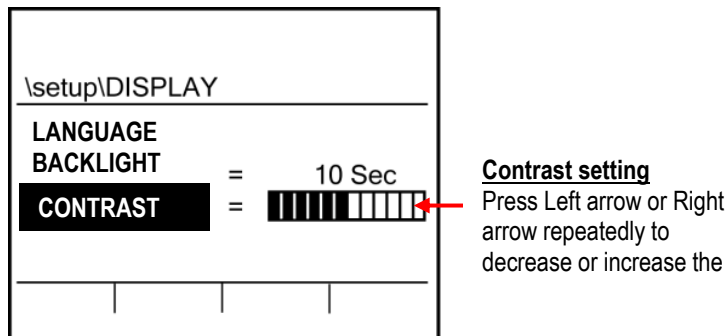

Figure 3-12: Contrast setting

Advanced setups

This chapter covers the SoundPro® models SE and DL features listed below, all of which provide capabilities beyond the essential ones required for basic model setup and basic sound measurement. For information about basic SoundPro models SE and DL features and setups, see Chapter 3, “Basic setups.” For information about the notation and navigation conventions that are used in these explanations, see Chapter 1, “Introduction.”

- **Auto-Run** - Similar to an “Auto-Start” feature, it will automatically start and stop sessions based on time, date, duration settings and level- triggered run mode (which is used to control runtimes of studies and sessions using internal and external signals.)
- **Triggering** - Control the runtimes of studies and sessions using internal and external signals.
- **Security** - Prevent certain uses of the instrument by anyone who does not know the security codes (available for all instruments).
- **Logging** - Periodically save selected measurements at a preset interval during all studies of a session (only for DL models).
- **GPS** - Obtain position and time information from the global positioning satellite system, and store that information with each study that you perform (only available if you have a compatible GPS receiver).

Auto-Run

SoundPro SE/DL has four automatic run modes which include: Date auto-start with duration, Day of the Week auto-start with duration, Timed Run (duration only setting), and Level Triggered Runs (or Level auto-start runs).

Setting up auto-run

All Auto-Run setups begin in the Auto-Run screen. The Auto-Run screen shows the current status of the Auto-Run feature. The following features are available: Disabled, Timed Run, DOW (day of week), Date, and Level-Triggered settings.

Date setting

A Date mode run wakes up the instrument from a powered down condition, runs the study, saves it, then powers down again and is only executable once. The parameters are selectable by specified dates and times with up to four programmable individual setups.

A plus sign preceding a number (i.e., +1) indicates if one of the four settings is enabled (or activated) where as a negative sign (i.e. -4) represents a disabled (or deactivated) setting.

➤ Setting up or changing auto-run with date parameter

1. From the start screen, press **Up/Down ▲ /▼** to highlight **Setup** and press **Enter ↵**.
2. Select **Auto-Run** by using **Up/Down ▲ /▼** to highlight and press **Enter ↵** to select.
3. In the Auto-Run screen, repeatedly press **Enter ↵** until **Date** appears.

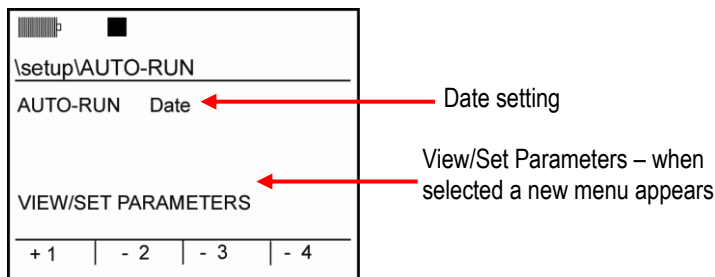

Figure 4-1: Auto-Run with Date selected

4. To select **View/Set Parameters**, press the **Down** arrow to highlight and press **Enter ↵**.
 5. Press one of the four soft keys in the Auto-Run Date screen to assign a numbered setting (i.e., "Auto-Run #1").
- ☑ NOTE:** If setting up for the first time, the Date screen will appear as "Auto-Run" "Off." To turn on Auto-Run # 1, #2, #3, or #4, select the appropriate soft key. (For example, Figure 4-3 displays setting up soft key #1 parameters. When activated a "+" symbol appears.)

6. To set **Date** values, press **Enter** (↵) to move to the first field.
 - To change the fields, press repeatedly **Up/Down** (▲/▼). To move between the day, month, and year fields, press the **right/left arrows**.

Auto-Run #1
Indicates which 1-4 soft keys is being viewed or set

Date Settings
Day, Month, Year fields

Time settings
Add Start time (S) (8:15:00am)
Add Duration (D)
(16 hr, 30min, 0 sec.) (or 6:30:00pm)

Example: Press first soft key to activate "Auto-run #1" settings

Figure 4-2: Setting Date parameters for Auto-Run #1

7. To enter **Start (S) Time** and **Duration (D) Time**, it is important to note that the settings are formatted as Hours:Minutes:Seconds and based on a 24-hour clock. In Figure 4-3, the Start time is indicated as "16:30:00" which is equivalent to 4:30pm.
 - To Set, press **Up/Down** arrows to increase/decrease values. To move between each increment, press **Enter** (↵).
8. To set additional Auto-Runs, repeatedly press **Enter** until "Auto-Run" is highlighted. Then press **Enter** (↵) to toggle on the Date and Time settings. Then follow steps 5-7.
9. To exit the screen, press **On/Off/Esc** (⏻) repeatedly until you return to the main screen. Press and hold the **On/Off/Esc** (⏻) to power off.
 - ☑ **NOTE:** To enable Auto-run, ensure the instrument is powered off and the date and time settings were programmed for the future.
10. When powered off, an Auto-Run shutdown screen will appear. (Please see section, "Auto-Run shutdown screen.")

Days of week setting

The Days of the Week (DOW) setting is a pre-programmed weekly auto-run with specified days, start time, duration. You can pre-program two auto-on settings with Sunday through Saturday parameters, one specific start time, and a specified duration for each auto-on setting. (See Figure 4-4 as an example for settings.)

- ☑ **NOTE:** In order for the Days of the Week mode to autorun, ensure the instrument is in the “off” position. The meter will then automatically switch into Auto-Run based on your setup.







Days of Week (Auto-Run) setting

To program Auto-On 1, first select the days of the week, then specify a start time for your test with a duration (to end your test).

Figure 4-3: Example of setting up Auto-Run (QSP-II)

A study run under the DOW mode wakes up the instrument from a powered down condition, runs the study, saves it then powers the instrument down again. The cycle repeats for the next time and day in the setup, and for the other Auto-on 2 if that is also activated in the mode.

➤ Setting the Date of Week (DOW)

- From the start screen, press **Up/Down ▲ /▼** to highlight **Setup** and press **Enter** .
- Select **Auto-Run** by using **Up/Down ▲ /▼** to highlight and press **Enter**  to select.
- In the **Auto-Run** screen, repeatedly press **Enter**  until **DOW** appears.
- Press the **Down arrow** to select **View/Set Parameters** and press **Enter** .
- To set the **Days**, press **Enter**  to move between the fields. To program a day, press **Up/Down ▲ /▼** to select a day setting. The first character of the day will appear when selected.
 - The Days field is organized in the following sequence: Sunday (S), Monday (M), Tuesday (T), Wednesday (W), Thursday (T), Friday (F), and Saturday (S).
 - For example, Figure 4-5 displays Sunday (S), Tuesday (T), Thursday (T), and Saturday (S) selected as pre-programmed run days.
- To set **Start time (S)** and **Duration (D)** for Auto-Run #1, press **Enter** repeatedly to move to Time line #1. Press **Up/Down** arrows to change the time and duration values. Press **Enter**  to toggle through the fields or press left/right arrows.
- (Skip this step if not setting auto-run #2.) To set auto-run #2, press soft key #2 until the screen displays a plus symbol in front of “2.” (This denotes it is “activated.”) Then repeat steps 5 – 6.

8. To exit the screen, press **On/Off/Esc**  repeatedly until you return to the main screen. Press and hold the **On/Off/Esc**  to power off.

Days field

Auto-run #2 is programmed to run Monday –Thursday and Saturday

Start time and duration

Auto-run #1 is programmed to run at 10:00am (“S”) for a duration (D) of 2 hours

\setup\AUTO-RUN\DOW								
Days		-	M	T	W	T	-	S
1	S	10:00:00	D	02:00:00				
2	S	14:00:00	D	02:00:00				
+ 1		+ 2						

Start time and duration

Auto-run #2 is programmed to run at 2:00pm (“S”) for a duration (D) of 2 hours

Figure 4-4: Day of the Week (DOW) setup

9. When powered off, an Auto-run shutdown screen will appear. (See section, “Auto-Run shutdown screen.”)

Auto-run shutdown screen

When either the Date mode or the Date of the Week (DOW) settings is enabled and you power down the instrument, you will be alerted by an Auto-Run Shutdown screen just before the instrument turns off. This screen, illustrated below, appears after the normal power-down countdown and remains visible for approximately ten seconds.

- NOTE:** The Auto-Run Shutdown screen never appears when Timed Run is enabled because that mode requires the instrument to be powered on.

Auto-Run (AR) #1 settings

- Date is displayed on first line
- Start time (ST) and runtime(RT) is displayed on second line

Auto-Run (AR) #2 settings

Displays the # of pre-programmed runs.

Shutdown\AUTO-RUN		DATE
AR #1	Tue 07 MAR 2008	
ST	13:00:00	RT 08:00:00
AR #2	Fri 10 MAR 2008	
ST	15:00:00	RT 02:00:00
Auto Runs configured: 3.		

Mode

- Either Date/ DOW

Figure 4-5: Auto-Run Shutdown screen

Auto-run shutdown screen explained

The Auto-Run Shutdown screen is a map of your auto-run settings. It identifies the mode, the activated setups in that mode (AR) and the order in which the setups will occur.

If Auto-Run is enabled in the Date mode and more than two setups are activated, only the first two will be shown because of limited screen space. If you power on the instrument after the first auto-run has been saved, view the study, and then power off the SoundPro meter, it will display the next two remaining auto-run settings.

- NOTE:** If the start time and date for a setup is already past, the run will not be identified in this screen.

Timed run setting

In Timed Run mode, you program the instrument's duration (or *timed run*) and then manually start your study, which can be applied as many times as you want. The auto-run will end when the duration expires.

➤ Viewing or changing the Timed Run setup

1. From the start screen, press **Up/Down** ▲ / ▼ to highlight **Setup** and press **Enter** ↵.
2. Select **Auto-Run** by using **Up/Down** ▲ / ▼ to highlight and press **Enter** ↵ to select.
3. In the **Auto-Run** screen, repeatedly press **Enter** ↵ until **Timed-Run** appears.
4. To set the duration, press **Enter** ↵ to toggle between the Hours, Minutes, and Seconds field. To change the time values, press **Up/Down** ▲ / ▼ repeatedly until the specified value is selected.
5. Press **On/Off/Esc** ⏻ repeatedly to return to the start screen. When you are ready to run your study, press **Run/Pause** ▶||.

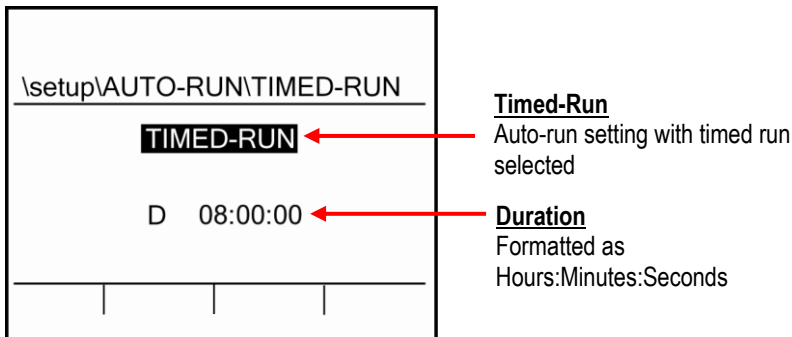

Timed-Run

Auto-run setting with timed run selected

Duration

Formatted as
Hours:Minutes:Seconds

Figure 4-6: Timed Run setup screen

Level-triggered auto-on setting

The level-triggered screen contains meter 1 parameters which include a Filter mode, Frequency level, “Level On” and “Level Off” modes, and a specification for either run/stop or run/pause modes.

➤ Viewing or changing level-triggered mode

1. From the start screen, press **Up/Down ▲/▼** to highlight **Setup** and press **Enter**.
2. Select **Auto-Run** by using **Up/Down ▲/▼** to highlight and press **Enter** to select.
3. In the Auto-Run screen, repeatedly press **Enter** until **Level-Triggered** appears.
4. Press the **Down** arrow to select **View/Set Parameters** and press **Enter**. The Level-Triggered Auto-Run screen will appear.
 - See Table 4-1 below for explanation of settings.

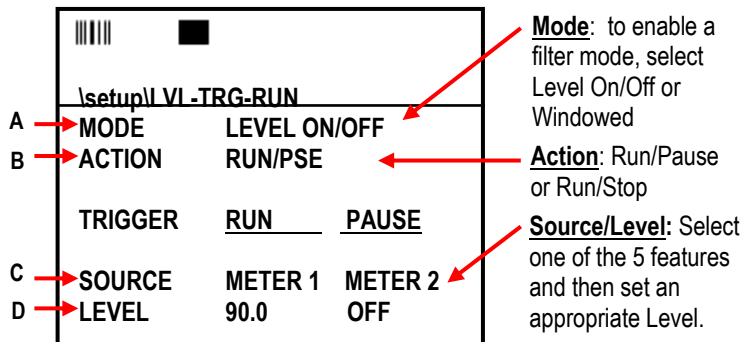









Figure 4-7: Level-Triggered screen

Level- Triggered	Explanation of Settings
A. Mode	<p>The mode, or Filtered Mode, can be set to Level On/Off and Windowed settings.</p> <ul style="list-style-type: none"> • In Level On/Off mode, the unit starts a run when the source level exceeds the specified criteria and stops/pauses when level falls below the off criteria. The on criteria is met and either pause or stop a run when the off criteria is met. • In Windowed mode, the unit starts a run when the selected criteria falls outside the defined window. This is intended primarily for curves but can also be used with broadband or individual filter measurements.
B. Action	<p>After selecting specific filter mode settings, the instrument is set to trigger based on Run/Pause mode or Run/Stop mode.</p>

Level- Triggered	Explanation of Settings
C. Source	<p>The source can be set to Meter 1, Meter 2, filters, curve, external trigger, timed run trigger mode, and a delay. which are explained below:</p> <ul style="list-style-type: none"> • Broadband: When selecting Meter 1 or Meter 2 for the triggering source, you then specify a specific value in the "level" field such as 85dB. • Filters: Octave band filters are selectable as a triggering source such as: 12.5 Hz, 16 Hz, 20 Hz through 20 kHz. NOTE: This is only available if they have purchased the 1/1 or 1/3 features. To select a filter, select an octave band value (.i.e. 10 kHz) in the source field. Then, select a Level value (i.e., 90dB). • Delay: When selecting Delay with a specified time value, it will trigger the auto-run after the timed-delay surpasses. (This is similar to setting a delay on a camera.) To select "Delay", select the Source as "Delay" and for Level select a specific time value (the range is from 00:01 seconds to 59:00 minutes). • Curve: If the curves feature has been purchased, you have the option of selecting one of the 4 captured curves to trigger a run. To select a captured curve, set the Source as "Curve" and then change the "Level" field to one of the following: CAP-1, CAP-2, CAP-3, or CAP-4. • EXT: External Trigger feature is triggered by the digital input on the curve indicator. To select external trigger, select "EXT" as the source field, and select "LO" for the level field. • TIMED: When selected as the RUN trigger, it will cause a delay of specified direction between the timed RUN button is pressed and the time the RUN actually starts. When selected as the PAUSE/STOP trigger, it sets a run length. To select under the Source and Pause fields, chose Timed. Next, select a timed value (or duration) in the Level field. (This is formatted as hours:minutes:seconds.)
D. Level	The level field corresponds with your selection from the Source field and is explained under "C. Source."

Table 4-1: Level Triggered Auto-On settings explained

5. To select the **Mode**, press **Enter**  repeatedly until you are viewing either **Level On/Off** or **Windowed**.
6. To move to the next field, press the **Down** arrow.
7. To set the **Action**, press **Enter**  repeatedly until you are viewing either **Run/Pause** or **Run/Stop**.
8. To move to the next field press the **Down** arrow.
9. To change the **Source**, press the right arrow. To select one of the five Sources (as explained above in Table 4-1), press **Enter**  repeatedly until you are viewing the appropriate feature.
10. To activate **Triggered Run** on the Meter 2, press the right arrow and select one of the five sources by pressing **Enter**  repeatedly until you are viewing the appropriate feature. (If you are only setting Meter 1, please skip this step.)
11. To move to the next field press the **Down** arrow.
12. To select a **Level**, press the Right arrow. Press **Enter**  repeatedly until you are viewing the appropriate setting.

13. Press **On/Off/Esc**  repeatedly to return to the start screen. When you are ready to run your study, press **Run/Pause** .

Locking setup or run mode

The locking or security feature is designed to lock the SoundPro meter during a run to ensure the study will not be stopped unless the lock feature is disabled. Likewise, this feature includes a locked (or secure) setup mode which will stop a user from editing a programmed setup. Once setup and enabled, the secure run or secure setup are unlocked, by pressing the Lock soft key and entering in the code.

NOTE: Security settings survive a shutdown.

Setting secure run or secure setup (locking)

Run Security and Setup Security are both enabled and disabled in the Lock screen. For **Secure Run**, you can be in pause or stop mode when locking.

For **Secure Setup**, you must be in stop mode to set and enable this feature.

About Secure Run

When you enable **Run Mode Security** and start a run, the Secure Run Mode screen appears (Figure 4-10). This will prevent users from viewing the measurements, changing parameters, and/or stopping the run. To stop the secured run, you will have to press the Lock soft key and enter in the code. Then, you would be able to stop the run by pressing the **Stop** key.

NOTE: With Run Mode security enabled, the Secure Run Mode screen always appears regardless whether the study was started manually, by Auto-Run or by Triggered studies.

About Secure Setup

Setup Mode security blocks access to setup screens while in stop mode. (**NOTE:** When in run mode, the SoundPro meter automatically blocks the user from changing settings to ensure the settings remain the same throughout the session.) Once enabled and the user selects setup, the Secure Setup mode prompt will appear and it prevents someone from changing settings until unlocked.

- Setting **secure** run or secure setup (locking)
 1. From the start screen, press the **Lock** soft key.

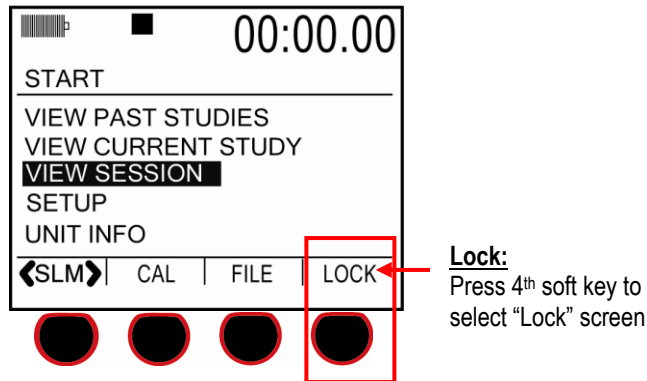

Figure 4-8: Secure/Lock option

2. In the Lock screen, there are two selectable fields:
 - **Secure Run Mode** with a status line
 - **Secure Setup Mode** with a status line.
 - Each **Status Line** is used to specify either a “disabled” state or an enabled state when a code is entered to assign an unlock code.

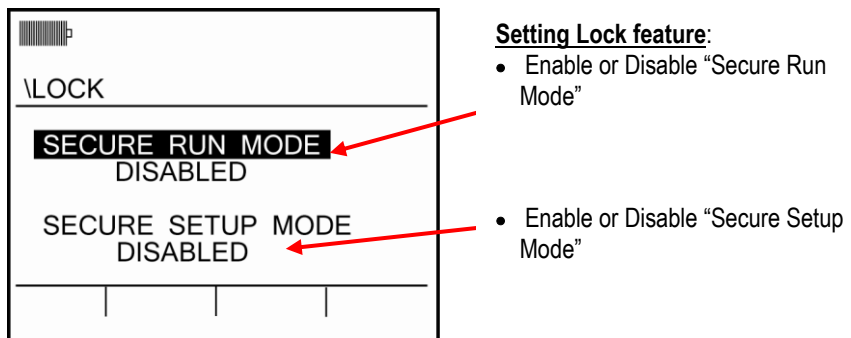

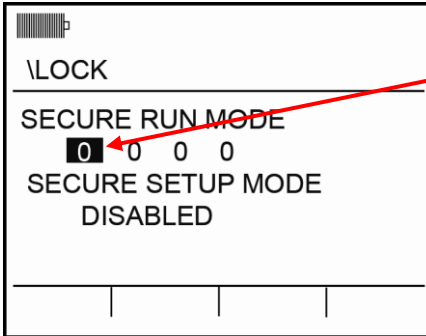

Figure 4-9: Secure/Lock screen



3. (Skip this step if securing setup and see step 4.) To set **Secure Run Mode**, press **Enter**  and "0000" will appear.

NOTE: If you want to set the code as "0000," press **Enter**  repeatedly until "enabled" appears. This will be the unlock code.



- Selected value is shaded
- Enter code by pressing up/down arrows to change value
Press enter to move to each field

Figure 4-10: Adding code for secure/lock screen

- To select a numeric code, press **Up/Down** arrows to select a number, press **Enter**  to toggle between the fields.
- Press **Enter**  to **Enable**.
- Press **On/Off/Esc** key to return to the **Start** screen. When you are ready to run a session, press the **Run/Pause** key and the Secure Run Mode prompt will appear. (See "Disabling secure run or secure setup" below for details on stopping the run.)

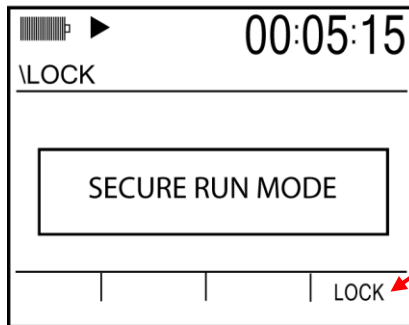

To unlock/unsecure
Press lock soft key and then enter in code.

Figure 4-11: Secure/lock run prompt

4. To set **Secure Setup Mode**, ensure it is highlighted by pressing **Down** arrow. Once selected, press **Enter** and "0000" will appear. (See Figure 4-10 for a screen example.) (Also, you must be in stop mode.)
- To select a numeric code, press **Up/Down** arrows to select a number, press **Enter**  to toggle between the fields.

- Press **On/Off/Esc**  repeatedly until the **Start** screen appears. This will **Enable** the Secure Setup (or locking setup).

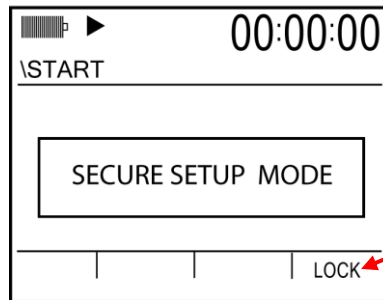

To unlock/unsecure

Press lock soft key and then enter in code.

Figure 4-12: Secure/lock setup prompt

Disabling secure run or secure setup (unlocking)

You can disable Setup Mode security only when the session is stopped.

➤ From Secure Run or Secure Setup screen

1. Both screens will have a Lock soft key (see Figures 4-11 or 4-12).
2. Press the **Lock** soft key and the code will appear (see Figure 4-10 for example).
3. Enter in the code (using **Up/Down** arrows to change value and **Enter** to move to next field).
4. Press **Enter** to exit the code field. Disabled will appear indicating the lock feature is turned-off.

Secure code backup number

If you forget your own security code, you can enter “9157” in the template to disable Secure Run Mode or Setup Mode Security.

➤ From the Start screen

1. In the Start screen, press the **Lock** soft key. The Lock screen appears.
2. Follow Steps 2-4 above, “Setting secure run or secure setup.”

Digital outputs/Triggering

All digital output signals (also referred to as “**Triggering**”) appear on pins of the Auxiliary Port (“Auxiliary port”). Manage these digital outputs in the Ext-Trigger screen.

Tracking runs

The instrument can be configured to use a digital output to signal the start or end of a run.

➤ Enabling or Disabling run/pause digital outputs/triggers

1. From the start screen, press **Up/Down ▲ /▼** to highlight **Setup** and press **Enter ↵**.
2. Select **Digital-Out** by using **Up/Down ▲ /▼** to highlight and press **Enter ↵** to select.
3. Press **◀/▶** to select **Output 1**.
4. Press **▶||** to **enable (Run/Pse)** or **disable (Off)** run tracking.
5. If you enabled and want to reverse the trigger logic, continue below. Otherwise, skip to step 9.
6. Press **◀/▶** to select Logic 123, then press **↵** to enter the first data field. The second data field is for Output 1.
7. Press **◀/▶** to select the second data field, then press **↵** to toggle the logic state. The displayed logic state is for a running study.
8. Press **↶** to **exit** the Logic 123 data field.
9. If finished, press **↶** to **exit** the screen.

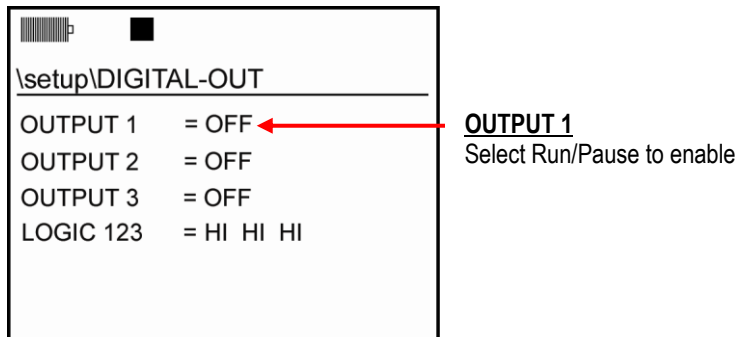











Figure 4-13: Digital-Out screen

Digital outputs and SPL

The instrument can also be configured to use a digital output to signal if the current SPL measurements exceeds a specified level.

➤ Managing SPL digital outputs (See Figure 4-13 above)

1. Open the **Digital-Out** screen, by selecting **Setup** from the start screen. (Press ▲/▼ arrows to select **Setup** and press .
2. Press ◀/▶ to select **Output 2** or **Output 3**, then press  to move the cursor to the data field at the right. You have two options for each output.
 - **OFF** - Disables SPL tracking for that output.
 - **dB level** - Enables and shows the current setpoint for that output.
3. Press  to toggle between these options. If you select “Off,” press  to exit the data field, then skip to the last step of this procedure. If you enable the trigger, continue below.
4. Press ◀/▶ if you want to change the setpoint.
5. Press  to exit the data field.
6. If satisfied with the trigger logic, skip to the last step of this procedure. To toggle the logic setting, continue below.
7. Press ◀/▶ to select **Logic 123** then press  to enter the first data field. The third and fourth data fields are for Output 1 and Output 2, respectively.
8. Press ◀/▶ to select the appropriate data field.
9. Press  to toggle the logic state. The displayed logic state is for SPL that equals or exceeds the setpoint.
10. Press  to exit the **Logic 123** data fields.
11. If finished working in the Ext-Trigger screen, press  to exit the screen.

Communications

The SoundPro Sound Level Meter has both USB and RS-232 communication channels. The majority of users should only require USB communications, which is vastly faster than the RS-232 channel which is intended for low speed modems GPS applications, and/or log-to-port applications but may be used to communicate to a PC as well. The optional 053-729 Serial Cable is required for RS-232 communications.

The SoundPro meter has two USB communications modes “QSP/Serial and “Mass Storage.

QSP/Serial

For QSP-II communications, USB should be set to “QSP/Serial” (Figure 4-14). The RS-232 channel should be turned off for low power consumption.

 \setup\COMM-SET	
USB	QSP/Serial
RS-232	Off/Lo-Pwr
BAUD-RATE	4800

Figure 4-14: QSP/Serial

Mass Storage

When the USB channel is set for Mass Storage mode, you will have direct access to the instruments SD card through programs such as “Windows® file manager.” Much the same way a small pocket USB flash drive operates. When obtaining data from the SoundPro meter via Mass Storage, it is important to remember that the data obtained is in Native SoundPro SES format (It cannot be read with Microsoft® Excel® spreadsheet program, Microsoft® Word® processing program, etc.) A SoundPro SES to XML conversion utility is available.

- NOTE:** When using Mass storage, you must use the Windows “Safely Remove Hardware” feature to un-mount the SoundPro meter from the PC in the same manner you must remove a flash drive. This “Windows” feature is usually found in the lower right-hand side of the windows systems tray.

 \setup\COMM-SET	
USB	Mass Storage
RS-232	Off/Lo-Pwr
BAUD-RATE	4800

Figure 4-15: Mass Storage

➤ USB communications

1. If a session is running, stop it.
2. In the **Start** screen, press ◀/▶ to select **Setup**, then press ↻. The Setup screen appears.
3. In the **Setup** screen, press the arrow keys to select **Comm Set**, then press ↻ and the Comm-Set screen appears.
4. USB should be Highlighted. Press ↻ to toggle between “DMS (QSP)/Serial” and “Mass Storage.”
5. If the RS-232 channel is not set to “Off/Lo-Pwr”, press the left arrow to highlight RS-232 and repeatedly press ↻ until Off/Lo-Pwr is displayed.
6. Press ↻ to exit the screen.
7. Connect the small end of the USB cable to the USB port (“Hardware interfaces”).
8. Connect the large end of the USB cable to a standard-sized USB connector on the computer.

Viewing real-time measurements remotely

On the SoundPro, the “**Log to Port**” feature, provides the functionality to stream logged data out the serial port at the log rate to an external device (such as a PC). With this feature, you are able to view logged measurements for broadband as well as filter band average measurements (depending on the model you ordered). It will not report Lmax, Lmin, or Lpk for each filter band.

➤ Turning on log to port

1. In the **Comm Set** screen (selectable via the Set-up screen), select RS-232 field (by pressing the down arrow).
2. Press ↻ repeatedly to turn on **LOG PRN**.

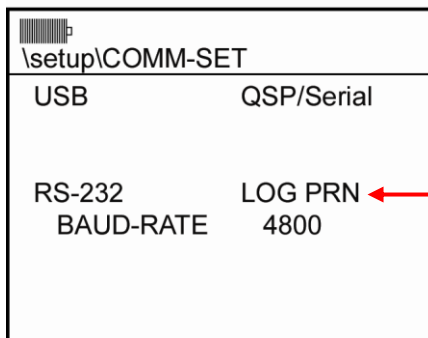

LOG to Port
Press **Enter** key repeatedly to activate

Figure 4-16: Log to Port

GPS

The SoundPro Sound Level Meter has the capability of embedding GPS information into study headers. To interface a GPS, you need a GPS receiver with RS-232 communications that conform to NMEA 0183 version 2 and the optional 053-729 Serial Cable. In many cases, a Male-Male DB-9 null modem connector will be required as well.

The SoundPro meter will keep a GPS fix for up to 1 minute before declaring it invalid at which time “No Fix” will appear if you are in the “COMM-SET” menu. In other screens where a RUN may be initiated, “GPS +” or “GPS-” is momentarily flashed in the Right Soft key indicating either a valid fix “GPS +” or an invalid or timed out fix “GPS-.”

- ☑ **NOTE:** GPS time can be viewed in the Comm Set screen but is not used in the instrument or added to session files. Time and date stamping in session files uses information that is manually entered (“Time and date”) or downloaded from QSP II (“Information screen”).

GPS display

You can view GPS data in the Comm-Set screen. The position coordinates are stored in each study, when GPS is enabled and can be viewed with DMS.

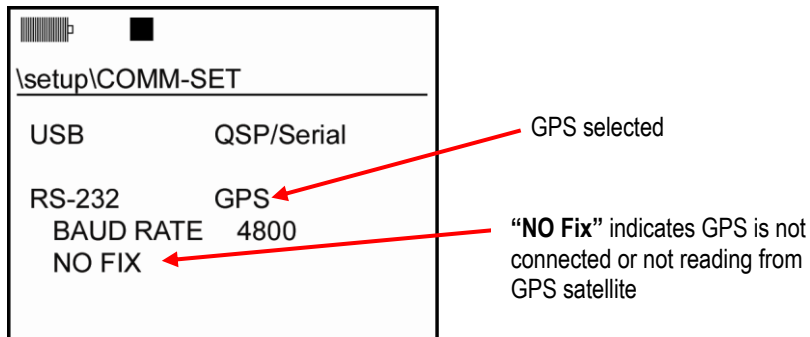

Figure 4-17: Comm-Set screen for GPS data

GPS explained

The top two screen selections, Interface and Baud Rate, specify the GPS setup, which is explained under “Enabling GPS communications,” below. The rest of the information in the screen appears when GPS communications is enabled and data is being received from a GPS satellite.

- Status line** - This data field at the right on this line tells you whether GPS is enabled or not. You may see “No Fix” below this line, which tells you that, although enabled, the instrument is not receiving the satellite signal.
- Position line** - When the satellite signal is being received, there will be two data fields on this line that give the instrument’s latitude (N or S) and longitude (E or W) position in degrees and minutes.

- **Other line** - When the satellite signal is being received, there will be two data fields on this line that give the instrument's altitude and time, in that order. The altitude is given in meters above mean sea level. The time is given for Greenwich, England (GMT) and differs in hours from your time by the number of time zones between your location and Greenwich.

➤ Enabling GPS communications

1. If a session is running, stop it.
2. Connect the RS-232 cable to the GPS receiver and to the auxiliary port of the SoundPro SE/DL instrument ("Auxiliary port").
3. Referring to the user manual for the GPS receiver, prepare the device to receive satellite signals.
4. In the SoundPro SE/DL Setup screen, press the arrow keys to select **Comm-Set** then press , and the Comm-Set screen appears.

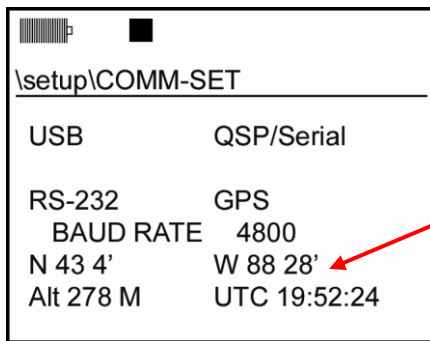



Figure 4-18: Viewing GPS coordinates in COMM-Set screen

5. Press the down arrow  to highlight "RS-232."
6. Repeatedly press  until "GPS" is displayed. The Baud rate should be kept at 4800 unless otherwise specified by your GPS manufacturer.
 - ☑ **NOTES:** If you are not using RS-232 communications in any way, you should keep the RS-232 channel set to the Off/Lo-Pwr setting.

Preparing to measure and running

This chapter explains the steps needed to prepare the SoundPro® Sound Level Meter for measuring and how to run measurements. It will also show you sample measurement result screens and explain the contents of the screens.

Virtual meters

SoundPro SE/DL meter operates with two parallel measurement systems called meters. Each meter obtains the same input from the microphone, processes the information through the same SoundPro SE/DL circuits and displays the measurement results in the same screens. The differences lie in the parameters used by each meter to process the signals. You can get different measurement results by setting the parameters for each meter differently.

Meter 1/Meter 2 explained

Meter 1 and Meter 2 enables you to setup and monitor two instruments in one (also referred to as a “virtual instrument”). “Meter 1” is the primary meter. “Meter 2” is the secondary meter. If a filter option is installed in the instrument, the filtered measurements are associated with “Meter 1” only.

Setting Meter 1/Meter 2 Parameters are explained in Chapter 3. (See Figure 3-4 for a screen example.)

Measurement notation (IEC/ISO)

Many of the instrument’s measurements are labeled in accordance with notation standardized jointly by the International Electrotechnical Commission (IEC) and the International Standards Organization (ISO). This notation identifies the measurement and the meter’s frequency and time response settings when the measurement was obtained. Table 5-1 provides a couple measurement examples. For additional information about measurements and measurement parameters, see Appendix B, “Glossary.”

Notation	Explanations
LCS	SPL measured with C-weighting and slow response.
LCS _{av}	Average SPL with C-weighting and slow response.
LAP _k	Peak SPL with A-weighting
LCS _{Mx}	Maximum SPL with C-weighting and slow response.
LCS _{Mn}	Minimum SPL with C-weighting and slow response.

Table 5-1: Measurement notations

Overview of running a session/study

The list below is a brief overview of the steps for running a study.

Quick Help List

1. Turn the SoundPro Sound Level Meter on and check your battery power (see Chapter 1).
2. Format the card or delete session files from the SoundPro meter.
 - Formatting the card will clear out all of data before your study begins. Choosing to select specific session files and delete will also clean up the instrument's sessions (see Chapter 7).
3. Adjust your settings to fit the specifications of your sound study (see Chapters 4 and 6).
4. Set the measurement range (see Chapter 5).
5. Calibrate the SoundPro meter (see Chapter 5).
6. Position the SoundPro meter in the field and connect appropriate external devices if applicable.
7. Press the **Run/Pause** key to start the session (see Chapter 5).
8. To Pause the session (if needed) press the **Run/Pause** key (see Chapter 5).
9. When you are ready to end your session/study, press the **Stop** key.
NOTE: You must be in pause mode to stop a session/study (see Chapter 5).
10. Review your measurement results on the SoundPro display (see Chapter 5). Or view results in QSP-II, see Communicating in Chapter 8.

Preparing to measure

Sessions and Studies

Before you begin running a session/study, there are a couple items to consider:

- Understanding sessions and studies
- Adjusting the measurement range before running a study
- Calibrating the instrument

The following components explain how the data is stored on the instrument.

Storing Data	Explanations
Session	A session is comprised of one or more studies and uses data derived or accumulated from those studies to arrive at session results. The measurements in a session are the same ones made in each study in the session. For example, the maximum SPL determined for each study in a session is compared to the maximums for each other study in the session to determine the maximum SPL for the entire session. Likewise, an average or an accumulation for a study is continued using data from subsequent studies in the session to arrive at the corresponding average or accumulation for the entire session.
Studies	Studies are periods in a session during which measurements are acquired, processed and saved by the instrument. The duration of each study period is called the study's run time.
Session and Study Scenario	You will be running a sound test in a machine shop. Your main objective is to determine the noise in three different work areas of the plant which include two different machinist areas and a welding area. You set the SoundPro to run and pause three times at one-hour intervals. When the tests are completed, you upload the data into QSP-II. The tests will store as one " Session " under "Downloaded" node and each one-hour test is denoted as a " Study ."

Table 5-2: Sessions and studies explained

- CAUTION:** The memory card should not be inserted or removed during a study or you could lose data.

Measurement range

You select the decibel range before running the first study in the session. Setting the measurement range helps keep the desired measurements within the linear range of operation. If you do not make an optimal range selection, low levels of sound can be hidden in the instrument noise (below the noise floor of the instrument), and high levels of sound can be distorted (the instrument is “overloaded”). Measurements at these extremes are invalid. For information about these and other terms that may be unfamiliar to you, see the glossary in this manual (Appendix B, “Glossary”).

➤ Measurement range selection

- From **Start** screen, select either **View Current Study** or **View Session**. The bar chart screen appears. To select, press **▲/▼** arrows and then press **↻**.
 - NOTE:** The bar chart screen may appear with a different measurement displayed and a different range. This is dependent on the settings you may have selected. (For more information, please see “Measurement Type.”)
- (Depending on if you selected basic SLM or applied 1/1 or 1/3 octave band filters) a bar chart screen or a filtered bar chart screen will appear, press **▲/▼**. This changes the range, and the change is confirmed in the screen in two ways.
 - **Ranges** - A different range may appear each time you press an arrow key. The instrument provides eight selectable ranges, each with different minimum and maximum values. (For more information about ranges, please see “Ranges” in the Specifications in Appendix A).
 - **SPL value** – Depending on if you have the instrument set to measure basic sound level measurements (see “A” below) or filtered sound level measurements (see “B” below), the following two types of screens may appear. The level increases or decreases in relation to the range selection

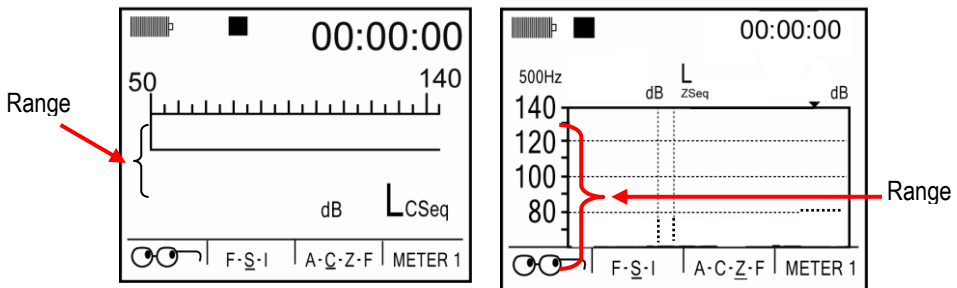

Figure 5-1: Bar chart screen (A) and Filtered Bar Chart (B)

Calibrate

TSI recommends calibrating your Verifier before you run a STI-PA measurement and after to ensure highly accurate measurement results.

The microphone should be calibrated before use for a number of reasons.

First, the microphone is sensitive to humidity and pressure changes. Calibrating before taking measurements assures that your level measurements are accurate for the current environment. Performing a calibration verification (post-cal) allows you to verify that conditions have not significantly affected your readings.

Calibrating also serves the dual purpose of checking the microphone for significant damage, such as a torn or contaminated diaphragm.

You can calibrate the instrument in the field with reference to the output of a calibrated sound source. TSI offers a line of acoustic calibrators that are available (such as the QC10/20).

Calibration screen

The Calibration screen contains a calibration option, called **Calibrate**, and a Calibration History. The history shows Pre-Calibration (Pre-Cal) and Post-Calibration (Post-Cal) results for previous calibrations, as applicable. For each calibration type, the resulting SPL level is shown along with the time and the date of the calibration.

Pre-Calibration

The main reason to calibrate is to adjust the current microphone reading to match a reference input, usually provided by a calibrator.

A Pre-Calibration is conducted when the session is stopped. When you calibrate during a stopped session, the new calibration results replace the previous Pre-Calibration results and the Post-Calibration results are removed. You will always see the last Pre-Calibration results.

Post-Calibration

A post-cal is really a calibration verification; that is, it does not change the instrument's calibration. It compares the microphone's current level with the value read from the last calibration (assuming that the same source is used).

A Post-Calibration is a calibration done during a session pause. When you calibrate during a pause, the new calibration results replace the previous Post-Calibration results without affecting the Pre-Calibration results. You will not see Post-Calibration results if a pre-calibration was performed but not followed by a Post-Calibration.

Performing a calibration

Before beginning your calibration, ensure the calibrator has sufficient battery power to perform the calibration. Also, you will want to insert the “cal adapter” into the mouth of the calibrator.

If the SoundPro Sound Level Meter has a windscreen, please remove.

➤ Calibrating

1. Ensure the SoundPro meter is turned **On** and is either stopped or paused.
2. Attach the calibrator and cal adapter to the SoundPro meter. Set the calibrator to 1 kHz and 114 dB (if it is a selectable).



Figure 5-2: Attaching calibrator to SoundPro

3. From the Start screen, press the **Cal** soft key and the Cal screen will open.
4. Select **Calibrate** by pressing **▲/▼ Arrows** (if not selected) and press **Enter**  to open the Pre-Cal screen.
5. Switch **On** the Calibrator.

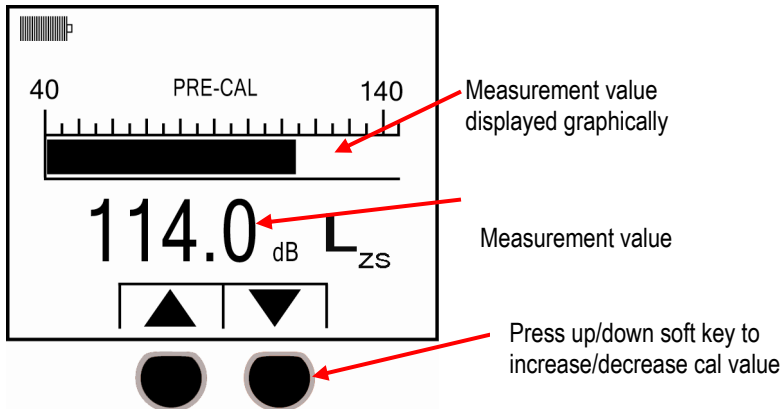



Figure 5-3: Setting pre-cal screen

6. Allow the measurement to stabilize and then press **▲/▼ Arrows** to set 114.0 dB level.
7. Press **Enter**  to store the new calibration. The Calibration History screen will appear with the new calibration values in the display.

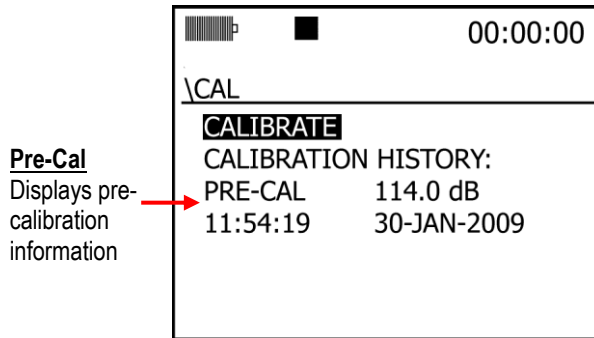



Figure 5-4: Calibration history screen

8. Press **On/Off/Esc**  key to exit the Cal screen.
9. For a **Post Calibration**, ensure the SoundPro is in "Pause" mode. (Essentially, run a **measurement** and press the run/pause key.) The Pause indicator will appear at the top of the display.) Then repeat the Calibration steps above and press Enter to store the Post Calibration information. A sample screen is displayed below with post calibration history.

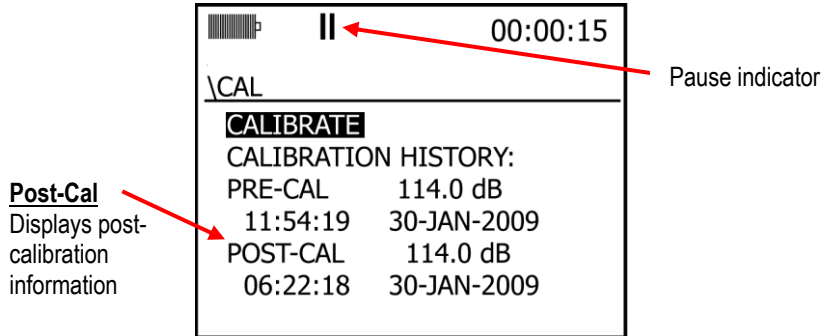



Figure 5-5: Post-Calibrate history screen

Running a session/study

You run a "session", commonly called opening a session, by running (or starting) the first measurement. To run a "study", you would press pause and then proceed in the run mode. This would save the measurement as a "study." Studies will be saved as you continue to run and pause your measurements. Once stopped, this will save as one session.

➤ Running a session/study

1. From the **Start** screen, select either **View Session** or select **View Current Study**.
2. To select, press **▲/▼** arrows and then press .
3. Press  to begin measuring. A session is currently open for the instrument when either the Run icon or the Pause icon appears in the Status Area at the top of the screen.

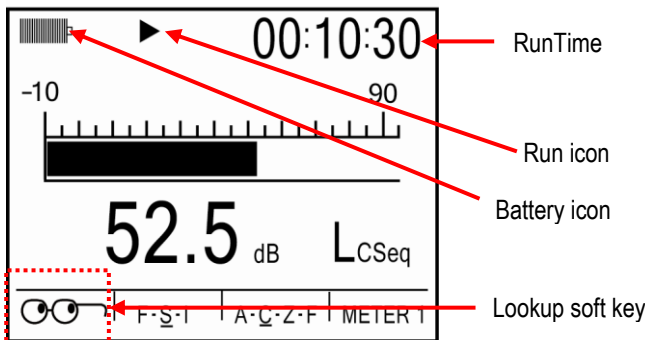



Figure 5-6: Bar Chart screen in run mode

- ☑ **NOTE:** The **Lookup soft key** is used to change the measurement options. There are five selections which include: SPL, Leq, Lpk, Lmax, and Lmin. (See “Changing displayed measurement” for more information.)

Measurement navigation

You can navigate through the measurement screens by repeatedly pressing . The first screen you encounter when viewing a measurement screen is a bar chart or filtered bar chart screen. The subsequent screens that appear depend upon the measurement setup, the meter selection and the type of analysis. There are four possible screen types:

Measurement screens	Explanations
Bar Chart or Filtered Bar Chart	Depending on if you selected SLM, 1/1 octave, or 1/3 octave, one of these screens will appear.
Tabular screen	Available for Meter 1 only. If your instrument contains a filter option and is set to an octave or third-octave analysis type, the screen that appears next in order after the Bar Chart is a Tabular screen. There may be one or more additional Tabular screens depending upon the analysis type that is in effect.
Dosimetry screen	Available for both meters, all viewing areas and all instrument types.
Community screen	Available only for Meter 1 and all instrument types, but not for studies. This screen will not appear when viewing the current study.
Time Log screen	Available for both meters, but only for broadband studies.

Table 5-3: Measurement screens explained

- ☑ **NOTE:** If you are **not** running a study when you enter a viewing area, only the SPL measurement is being measured and is available for viewing. The values for any other measurement in the Selection Panel discussed under, “Changing displayed measurement”, are replaced by dashed lines.

Using soft keys in measurement screens

The soft keys function in relation to the contents of the Soft key Region of the display. To use the soft keys, the menus are visible in Soft key



Region (i.e., “Cal” for Calibration menu). If necessary, press the Alternate Functions key () to toggle the contents of the Soft key Region.

Changing displayed measurement

You can change the displayed measurement in any viewing area at any time. There are five measurement options available: SPL (L_—), average SPL (L_{—av} or L_{—eq} depending upon the exchange rate setting for the selected meter), peak SPL (L_{—Pk}), maximum SPL (L_{—Mx}) and minimum SPL (L_{—Mn}). The labels comply with IEC/ISO notation (“IEC/ISO notation”), where the underline character represents the time response and frequency weighting settings for the selected meter.

➤ Changing displayed measurement

1. If necessary, press  (Alternate Functions key) to show the soft key labels.

- Press the  soft key to display the **Selection Panel**. The available measurements are arranged in a column, with the selected measurement marked.

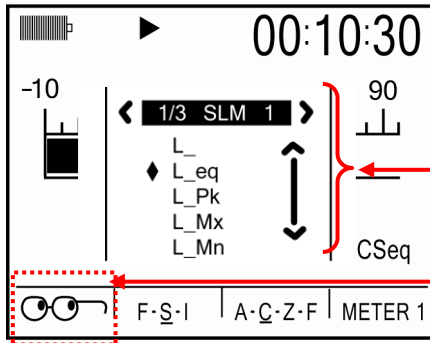





Selection Panel

This appears when lookup soft key is pressed.

The diamond symbol  indicates which measurement is selected. (L_eq). Press **Enter** key to confirm new selection.

Lookup soft key

Figure 5-7: Selecting measurements with Lookup soft key

- Press / to make a different selection.
 - With your selection marked, press  or press  to make the change effective.
- NOTE:** When viewing during broadband analysis, you can use the left/ right arrow keys to change measurements.

Analysis type, time response and weighting

If your instrument has a filtering option, you can change the analysis type. To change the analysis type, time response, and/or weighting, you must be in the View Current Studies screen or in the View Session screen. Also, the current session must be stopped (or “closed”). For more details on changing these options, please see “Measurement type” and “Meter 1/Meter 2 parameters.”)

Measurement screen icons

The measurement screen descriptors and icons identify certain conditions that exist currently in the display. Press  (Alternate Functions key) to toggle the contents of the Soft key Region until you see the Viewing Descriptors. When the Viewing Descriptors are displayed, an Alternate Functions icon appears below the battery icon.

The Broadband chart figure below displays an example of these icons and descriptors.

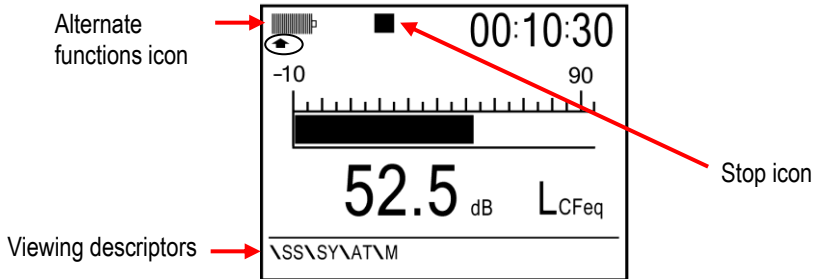

Figure 5-8: Example measurement icons & descriptors

Descriptor types

Viewing Descriptors	Explanations
SS	Session identification. This field tells you the name of the session that you're viewing, either the current one or the one you loaded before entering the viewing area
SY	Study identification. This field, which appears only when you are viewing a study, identifies the sequential number of the study in the session (01-99).
M	Measurement label. This field identifies the displayed measurement in IEC/ISO notation.

Table 5-4: Measurement icons and screen descriptors explained

Measurement screens

Bar Chart and Filtered Bar Chart

The first screen you will see in a viewing area contains a bar chart for broadband or filtered measurements.

For the bar chart screen, the amplitude of the displayed measurement is shown both graphically by the length of the bar and numerically below the bar. The bar appears (and usually fluctuates) if the measured value is above the minimum value for the selected measurement range.

For the filtered bar chart screen, the dominant characteristic of this screen is the multi-element bar chart. The chart shows measurements in each filter band and broadband values for both meters. That means that for octave analysis the screen contains 13 bars (11 for filters and 2 for broadband), and for third-octave analysis the screen contains 35 bars (33 for filters and 2 for broadband). A bars appears (and usually fluctuate) if the measured value for the bar is above the minimum value for the selected measurement range.

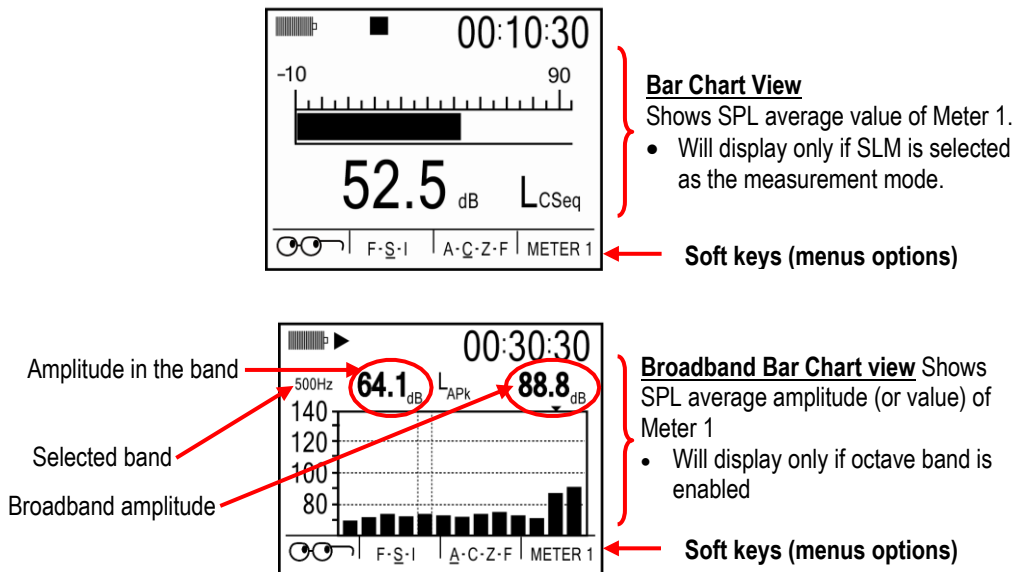

Figure 5-9: Bar Chart screen and Filtered Bar Chart screen

➤ Making changes to the Bar Chart or Filtered Bar Chart screen

- **The Range** - The scale, shown above the chart, is fixed and cannot be changed in the run or pause mode (or if you are viewing past studies). If the session is in stop mode (or closed), press ▲/▼ to change the range.
- **Soft keys**- If the session is in run, pause or stop mode you can change the following: Measurement displayed (via the lookup soft key) or Meter 1/Meter 2 screen. If the session is stopped (or closed), then you can also change the response time and weighting.

Community Noise screen

This screen shows the results of measurements commonly associated with community noise studies. Results are only available in this screen for those measurements that are activated for the current session on meter 1.

The screen components are explained in detail in the “Measurement setup for Community Noise.”

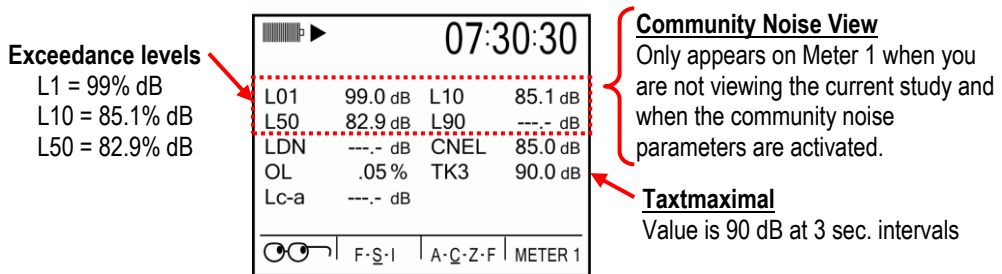

Figure 5-10: Community Noise screen

- NOTE:** Community noise measures are determined only for sessions, not for studies, so you will not see this screen when viewing current studies.

Dosimetry screen

The Dosimetry screen provides several types of measurements of the accumulated personal exposure to noise. See “Setting logging options” for details.

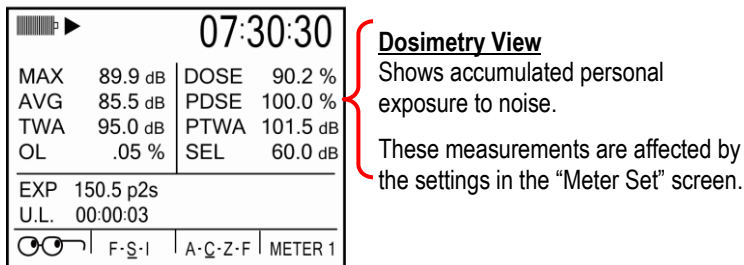

Figure 5-11: Dosimetry screen

Dosimetry measurements

Dosimetry measurements depend upon the run time—the longer the run time the greater the accumulated dose. Accordingly, dose measurements will either remain the same or grow during a study or session. They are determined from broadband data regardless of the selected analysis type.

Tabulation screens

The Tabulation screen shows measurements for two broadband measurements and for all the bands for the selected analysis type. For octave analysis, all bands are visible in a single tabulation screen. When viewing third-octave analysis, however, it takes three screens to display the tabulated measurements for all bands. Press to ◀/▶ cycle through them.

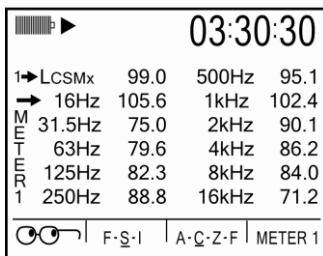

Tabulation view

Shows the average SPL on Meter 1 only.

- Only available if a filter option and 1/1 or 1/3 octave band is enabled on your meter.

Figure 5-12: Tabulation screen for octave filtering

1/1 and 1/3 octave analysis measurement results

- **Measurements and meters** - All tabulated values in this screen are for the displayed measurement and the selected meter.
- **Broadband measurements** - The first measurement in the screen is a broadband measurement for the selected meter. Following that measurement, is the number of the selected meter (Meter 1 in this example).
- **Filtered measurements** - After the broadband measurement, all other measurements given in the display are for Meter 1 in each of the frequency bands according to the type of analysis performed. For each band, the center frequency of the band is given and the measurement in that band is given at the right of the band's identification.

Time History/Back-erase screen

When conducting a broadband study, you can view as much as the last 20 seconds of Max SPL in this screen. The current Max appears at the right border of the Time Log chart (time=0) and advances, in one-second increments, toward the left border of the chart. The data leaving the chart at the left border is always a measurement that occurred 20 seconds ago.

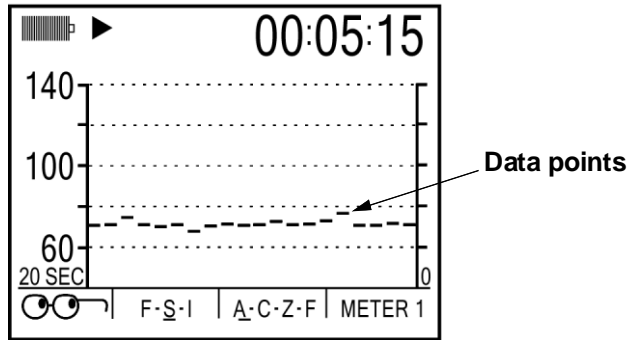

Figure 5-13: Back-erasing

Back-erasing

You can remove undesirable data at the end of a study with a process called back-erasing. Back-erasing is available only under these conditions.

- **Analysis type** - Back-erasing is unavailable for filtered studies.
- **Viewing areas** - You must be in either the **View Current Studies** or **View Session** viewing area. Back-erasing is not available in **View Past Studies**.
- **Restricted to the pause** - You can back-erase only during the pause that follows a study. Back-erasing is not available for past studies in the session.
- **Not all studies** - Because back-erasing requires a manual intervention, it is unavailable for triggered or Auto-Run studies.

Results of back-erasing

Back erasing causes the following changes to the study and to the session in which the study occurs.

- **Run times** - The run time of the back-erased study is shortened by the duration of the removed segment. The run time of the session is also reduced by the same amount.
- **Measurements** - All measurements that use data that was removed by back-erasing are corrected, as appropriate. For example, if the maximum SPL had occurred in that erased segment, the instrument re-evaluates the remaining data in the study to find a different maximum value.
- **Meters** - Back-erasing applies on the same basis to both meters.
- **Storage** - The session file is corrected to reflect the new run times and other changes that resulted from the back-erasing.

- **Back erased raw data** - The raw data that you removed by back-erasing is saved in the session's file. You can post-edit back-erased data with DMS software.
- **How to back-erase**
1. While running a study, view the **Time Log** screen in either the **View Current Study** or the **View Session** viewing area.
 2. If you see data that you would like to remove from the study, press the pause key to pause the study.
 3. Press the left arrow to move the back-erase Time Line from right to left. With reference to the Time Log figure below, the Time Line starts at the Zero Marker and can be moved all the way across the screen to the 20-second Marker. All of these characteristics help you identify the segment to be back- erased.
 - **Zero Marker** - Identifies the end of the back-erased segment. This is always the end of the study.
 - **Time Line** - Identifies the beginning of the back-erased segment. **Duration** - The length, in time, of the segment to be back-erased is given in the Soft key Region of the display.

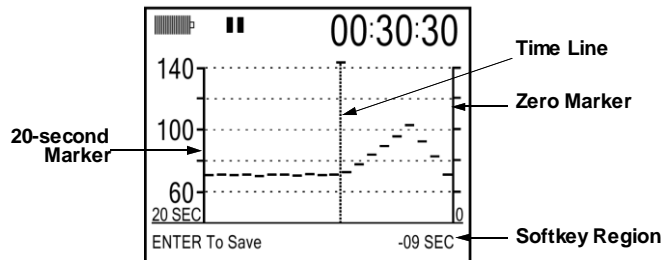

Figure 5-14: Time Log screen

4. You can adjust the **Time Line** by pressing ◀/▶.
 5. When you have the **Time Line** in position, press ⏸. The Time Line disappears and the soft key labels appear in the Soft key Region of the display.
 6. To cancel this screen, press ◀/▶ to begin the process again. The Time Line will reappear and you can select a different segment to back-erase.
- ☑ **NOTE:** At any time you can leave the time log screen, and return another time to edit the back-erase segment provided that you have not started another study.

Stopping a session

You can stop the session manually or with a trigger command, but only when the instrument is in the Pause state. When the session is stopped, the Stop icon ■, appears in the Status Area and the RunTime clock is zeroed. For information about using triggers, see “Digital Outputs/Triggers.”

Stopping a session is sometimes referred to as “closing the session.” Conversely, a session is often described as “open” when the instrument is either in a run or pause state.

Stopping and pausing

A manual session stop is a little different from a study pause. To **pause a study** ||, press the **Run/Pause** key and the command is immediately executed. To **stop a session** ■; however, you need to press and hold the **Stop** key.

If you do not press and hold the stop key for the 3-second countdown period, the stop command is ignored and the session remains open. If you hold throughout the countdown, the following events occur in proper sequence.

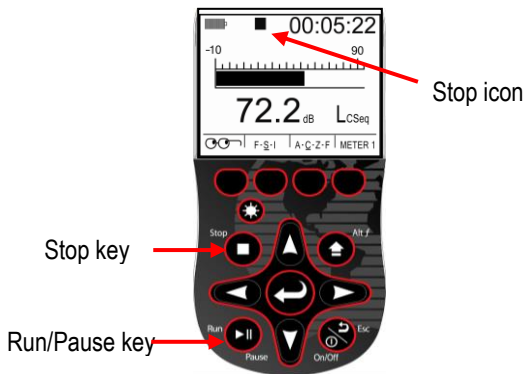

Figure 5-15: Stopping and pausing

- **Stopped** - The session is stopped.
- **Transferred** - The session data in memory is transferred to the memory card.
- **Cleared** - The instrument’s memory is cleared of session data.
- **Zeroed** - The RunTime clock is cleared to zero.

(This page intentionally left blank)

RT60, Curves, and STI-PA

Additional options

In this chapter, it is important to note that these features are additional add-on options and may not be available on your SoundPro® Sound Level Meter model unless you specifically purchased these features.

Reverberation

Reverberation is the distribution of sound in an enclosed space after the sound is removed or decayed. How is reverberation, or reverb, created in enclosed spaces? A sound is generated in an enclosed structure with a combination of the direct sound source (which travels from the sound source to listener by the shortest path without interfering with room surfaces) and the reflected indirect sound source. The total sound source echoes and decays as the sound is absorbed by the materials in the room (i.e., walls, carpet, furniture, concrete, etc...) and air. This is noticeable when the sound source stops but the reflections continue, decreasing in amplitude, until they can no longer be heard.

Reverberation time (RT60)

Reverberation time is a measurement used to evaluate and measure sound decay in a specific space, tailored to speech or music, such as: classrooms, auditoriums, gymnasiums, concert halls/theatres, (etc.). For room acoustic, results are used to ensure quality sound is evenly dispersed throughout a specific room with limited echoes/refractions. For music or performance auditoriums (i.e., symphonies), higher reverb. Time is preferred so the ending results are more robust.

The **Reverberation Time** over each octave band can be analyzed using a decay curve. Each octave band shows the time of sound at the start and after the activation of the noise system using either interrupted or impulse sound methods.

The example below displays the **Reverberation Time** in an enclosed room. **How it is measured with the impulse method:** (1) A starter gun provides a broad impulsive spectrum noise at 110 dB. The instrument automatically begins plotting the sound decay (see dB level 1) and stops as the noise falls off (see dB level 2). Hence, the rate of decay is calculated from decay curve (or regression line) which will give you the rate of decay in the room. The RT60 measurement is calculated with the Txx time (i.e., T20) factored in and extrapolated to a 60 dB drop.

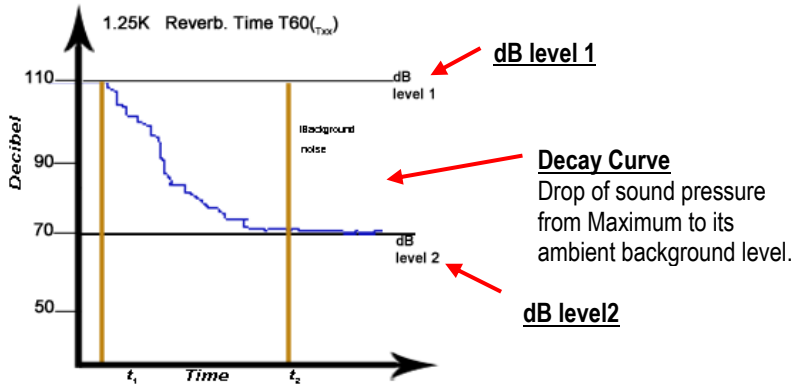

Figure 6-1: Reverb Time

Reverberation (RT60) methods

The two methods supported by the SoundPro are the Interrupted noise method and the Impulse noise method. While the initial sound source used is different, the ending decay curve results are very similar providing accurate RT60 measurements.

Interrupted noise

The Interrupted noise method, applied with pink noise, is used with a portable sound system, such as a dodecahedral speaker, or with an existing sound system (only recommended if the sound system has a quality, omni-directional, sound system.) With the interrupted noise method, the sound source emits a high-level source and falls-off, returning to its original ambient background level. The Reverb Time is measured between T_1 and T_2 indicators with an ending RT60 time value.

- ☑ **NOTE:** T_1 is calculated from two reference points on the regression line to ensure an accurate sound level capture

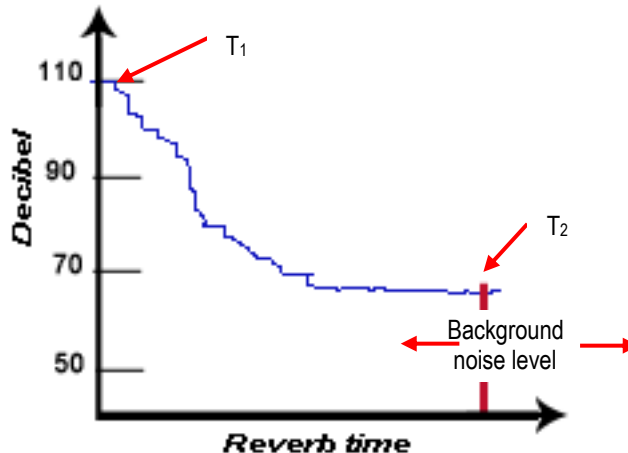

Figure 6-2: Interrupted noise example

Impulse noise

The Impulse noise method requires a broad-spectrum impulsive noise source, such as a starter pistol, in a room to be tested. Typically, the RT60 decay start will begin at a high-level source and decays, reporting a Reverberation Time.

Reverberation options









The following setup options are selectable via the **Reverberation Time** Options Setup menu (displayed in Figure 6-3).

Field Description	Explanation of field selections
Method - <i>Selecting the calculation process of RT60 reverb time.</i>	<p>Interrupted – (This is the default method setting.)</p> <p>Interrupted method uses a constant sound source (i.e., dodecahedral speaker), waiting for the level to stabilize, and then the source is turned off. (The method uses random noise or pink noise to test reverb. time.)</p> <p>Impulse – Impulse method is when the user tests the room with a broad spectrum impulsive noise, such as a starter pistol or a balloon popping.</p>
Averaging – <i>Selecting how it will calculate Average for Reverb-time</i>	<p>Measurement – The RT60 result times for each filter band of the 1/1 Octave or 1/3 Octave modes are averaged across the studies to arrive at a session average RT60 for that frequency band.</p> <p>Ensemble - The decay curves for each filter band of the 1/1 Octave or 1/3 Octave modes are averaged across the studies to arrive at an average session decay curve for that frequency band that is then used to calculate the session RT60 for that band. This results in either eight or twenty-four session ensembles, one for each frequency band in 1/1 Octave or 1/3 Octave modes, respectively.</p>
Threshold - <i>Specifies the dB level for triggering the start or run of the instrument. The interpretation of this field is dependent on the measurement method.</i>	<p>Auto - (This is the default threshold setting.) The instrument will automatically chose the level and calculate RT60. When in run mode, it sets the threshold relative to the noise level in the room. It provides a trigger level which is customized to each band.</p> <p>40 dB – 140 dB (in 1dB increments). The threshold decibel is user-selectable between 40 dB to 140 dB in one decibel increments.</p> <ul style="list-style-type: none"> • For Interrupted Noise method, level below this threshold will trigger the start of a measurement. • For Impulse method, levels above this threshold will trigger the start of a measurement.
Measure - <i>The expected decay value</i>	<p>Auto - (This is the default Measure setting.) The instrument will automatically pick the best Txx value based on the expected decay (i.e., T₂₀).</p> <p>T60 (T10 – T60) – (The default setting is Auto.) The selected “Txx” value is the actual amount of drop/decay the instrument measured. The selectable ranges are T10-T60.</p>
Filters - <i>1/1 or 1/3 bands</i>	<p>Measurements are plotted and stored in 1/1 or 1/3 octave band chart and decay chart. This field is only selectable if both 1/1 and 1/3 octave filter bands are installed features. Otherwise, the instrument will apply the installed filter.</p>

Table 6-1: Reverberation time set-up options

Setting up reverberation

The Reverb Time screen is used to change or view your reverberation settings. The steps below outline how to change the parameters. Please review Table 6-1: “Reverb time set-up options” for an explanation of parameters.

1. From the start screen, select **Setup** (by using **▲/▼ Arrows**) and press .
2. Select **Options** menu (by using **▲/▼ Arrows**) and press .
3. Select **Reverb Time** (by using **▲/▼ Arrows**) and press .
4. In the **Reverb Time** screen to change the settings, follow below:
 - To change the **Method** field, press  to switch between “**Interrupted**” or “**Impulse**” (when Method is selected).
 - To change the **Averaging** field, press  to switch between “**Measurement**” or “**Ensemble**” (when Averaging is selected).
 - To change the **Threshold**, press . Press  to toggle between “**Auto**” or a “**dB**” level value. To change the **dB** level, press **▲/▼ Arrows** to a specific decibel level is selected (i.e., 80 dB) (when Threshold is selected).
 - To change the **Measure** field, press  to toggle between “**Auto**” or an “**RT**” value is selected (when Measure is selected). To change, press **▲/▼ Arrows** to a specific decibel level is selected (i.e., 80 dB) (when Threshold is selected).
 - To change the **Filters** field, press  to switch between “**1/1**” or “**1/3**” (when Filters is selected).

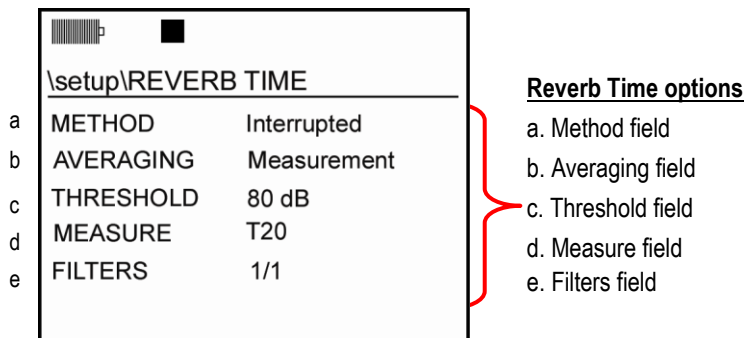

Figure 6-3: Reverb Time Setup screen

Running reverberation test

There are a couple factors to consider when conducting a reverberation test. Depending on if you will be measuring voice in a room, hall, theatre (etc.), ISO 3382 standard recommends measuring reverberation time for speech from 63 Hz to 4 kHz. However for rooms with other intentions (i.e., music/acoustical concerts), one-third octave bands from 100 Hz to 5 kHz can be used/applied. ISO 3382 also recommends a minimum number of recorded studies in order to obtain a reliable reverb measurement session. This is done for two reasons: (1) because the test signal is random noise, there will be a bit of run-to-run variance. By taking a number of measurements from the same location and averaging them together, you get a more reliable estimate of the actual measurement (2) Because the acoustics in a room may vary, it is suggested to do spatial averaging - taking measurements from multiple locations in the room and average them together to get an average measurement for the room.

Once the setup options are selected, please follow the procedures below to run and view RT60 measurements.

➤ Reverberation (RT60) Test

1. Select setup parameters via the **Reverb Time** screen (see “Setting up Reverberation” above).
2. (Skip this step if threshold is set to “Auto.”) View the ambient noise in the room (the L_{ZMAX} value) and note the value.

NOTE: To ensure a decay curve, at least 45 dB above background noise level is recommended.)

- To view the ambient sound in the room do one of the following:

(A) From the **Start screen**, select **SLM** as the measurement type and select **View Current Study**.

- Verify that the range setting is appropriate for the level being measured. It is desirable to select the longest range that will not overload. Press **Up/Down Arrows** to change range. (For more details, please see “Measurement range.”)
- Press **Run/Pause** key and notate the average level.

NOTE: You may need to press the Look-up  soft key and select **Leq** to view the average ambient sound level. For more information please refer to, “Changing displayed measurements.”)

- When completed, press **Run/Pause** key and then press **Stop** key to end the session.

(B) Follow “A” above but select **1/1** or **1/3** as the measurement type.

3. Select **RT60** as the measurement mode from the **Start** screen.

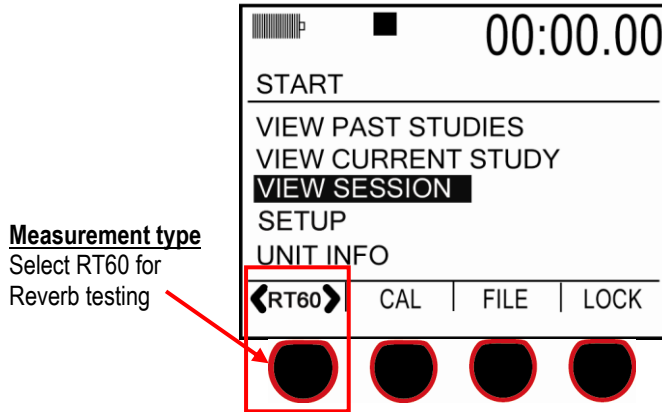



Figure 6-4: Reverb Time Setup screen

4. Choose one of the following methods to conduct your test:
 - **Interrupted Method:** Pump noise through room with existing sound system or a portable sound system. Allow level to stabilize. Then press **Run** .
 - **Impulse Method:** Press **Run** . Impulse the room with a broad spectrum impulsive noise (i.e., starter gun).
5. Depending on your **Setup** options, the **Reverb Time** will automatically trigger and record the results.
 - NOTE:** You may want to repeat this process a few times to ensure the readings are accurate. Once the RT60 is captured, a pause indicator will appear at the top of the screen. To run another study, press the **Run** key again and follow step 4. Or if you do not want to combine all of the run/pauses into a session, press **Stop** and then **Proceed** with the **Run** key and follow step 4.

Reverberation results

There are three viewable screen reverberation results which include the RT60 Summary chart, Decay Curve screen, and the Tabular Summary screen. When the SoundPro meter is in pause mode, you can view the charts and graphs by toggling through the screens via the Enter key. If you will be running multiple studies, you may want to review the data at the end of the session. In this example, you would access the File\Session\Data File screen and select a past study. (For more information, see “Viewing past sessions/studies” in Chapter 7.)

RT60 summary screen

This is a vertical bar chart that will plot the T60 values taken from each octave band or 1/3 octave band.

Viewing RT60 values of each band

- The decay value for each specific band is viewable by pressing the left/right arrow keys.
 - NOTE:** Bands with invalid T60 values will show dashes (---) instead of a value.

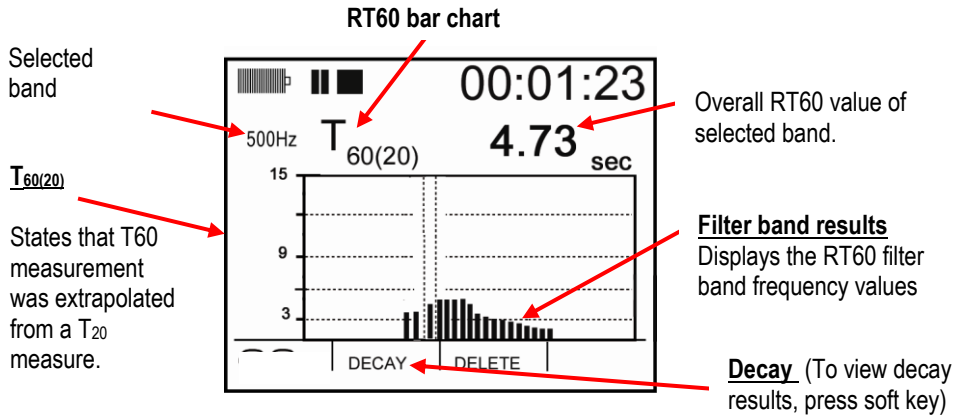

Figure 6-5: RT60 bar chart screen

Deleting RT60 value in a filtered band

This optional feature allows you to delete a selected filtered band from the session average and is available when in review mode of “view current study” screens. (This may be used, if for example, you had someone accidentally walk in during your test and begin speaking. You could delete the bands which interfered with your test from the RT60 average results.)

- To delete a filtered band, select either the RT60 Summary screen or the Decay curve screen.
- Select the band to be deleted (by pressing left or right arrows.)
- Press the **Delete** soft key. (Repeat steps if you want to delete more bands.)

Decay curve screen

This chart displays the (average or ensemble) results of a single Reverb Decay curve from the study (i.e., one filter band)/or the average of all studies within that session. (For more information, refer to “Sessions and Studies” in Chapter 5).

➤ Viewing decay value of each band

1. The decay value for each specific band is viewable by pressing the left/right arrow keys.

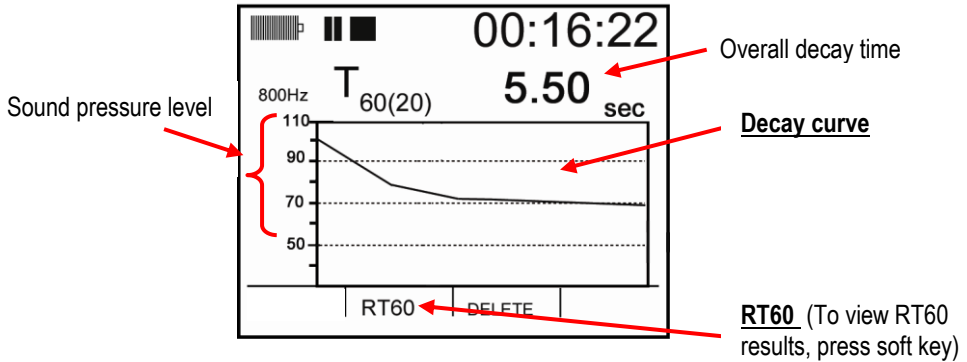

Figure 6-6: Decay curve screen

- ☑ **NOTE:** To delete a curve, please see “Deleting RT60 value in a filtered band” above.

Tabular RT60 screen

This is a table-formatted screen which details a summary of the Reverb Decay Curve of each band. The following table is a brief summary of the tabular data.

Column	Explanation of data
Freq	The Frequency column displays the chosen filter bands (for 1/1 Octave the range is 63 Hz – 8 kHz and for 1/3 Octave the range is 50 Hz – 10 kHz).
T60	T60 column displays the results of the decay curve in seconds.
R²	R ² column displays the reverberation time measurements. The values represent a “goodness to fit” ranging between 0 to 1 values, where 0 = failed and 1 = perfect.
Txx	Txx column displays the actual measurements of the RT60s’ values.

Table 6-2: Tabular RT60 field explanation

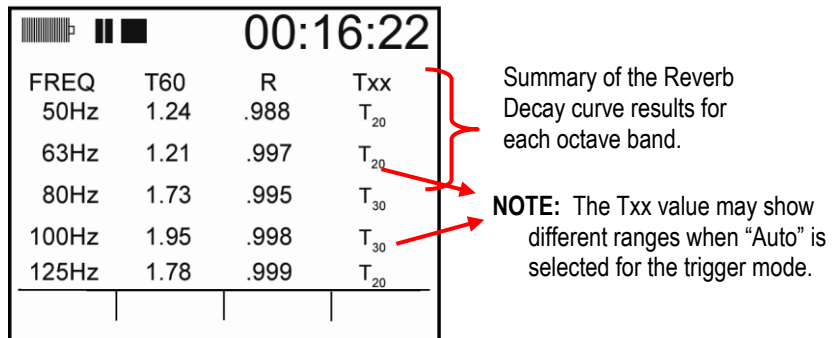

FREQ	T60	R	Txx
50Hz	1.24	.988	T ₂₀
63Hz	1.21	.997	T ₂₀
80Hz	1.73	.995	T ₃₀
100Hz	1.95	.998	T ₃₀
125Hz	1.78	.999	T ₂₀

Summary of the Reverb Decay curve results for each octave band.

NOTE: The Txx value may show different ranges when “Auto” is selected for the trigger mode.

Figure 6-7: Tabular octave filtering RT screen

NOTE: If “---”dashes appear, this indicates the measurement values are invalid.

➤ Viewing Tabulation RT60 screen

- To view all of the octave band filters, press the **Up/Down Arrow** keys to page through the filters’ data results.

Curves

Curves, also referred to as “Acoustic Spectral Curves”, is used to evaluate the quality of noise in new or existing buildings. The SoundPro models SE and DL support the following:

- Captured curves
- Noise Criterion curves: NC curves, PNC curves, NCB curves, NR curves, RC curves,
- Audiometric Booth Background Curves: ANSI 53.1, OSHA, and ISO AM Booth

Captured curves

Captured Curves, is a user-defined criterion curve, which allows the user to make a measurement with a 1/1 octave band frequency or a 1/3 octave band frequency distribution and save or capture the spectral curve. This snapshot can be displayed in DMS as a baseline or reference curve. A new measurement is then made and superimposed over the captured baseline curve to illustrate octave band frequency deviations from the original distribution, creating a user-defined criterion curve. This may be kept just as a reference, or it may be used as an evaluation for product or process comparisons, job task risk assessments, environmental investigations, and other applications.

Captured curve applications

- ☑ **Application 1 - Baseline:** Applying a captured curve as a **baseline** or reference curve for noise abatement investigation.
 - The operator captures the original noise and then makes various changes to the machine and/or enclosure and looks to see how much of a difference the change made.
- ☑ **Application 2- Quality Control:** Using a captured curve as a **Quality Control** (QC) evaluation. The instrument has been pre-loaded with a sound curve that represents the allowable levels for some product.
 - Once the product comes off the assembly line, it runs and the measurements are compared to the allowable levels. If levels exceed the curve, it is sent back for rework.
- ☑ **Application 3: Process monitoring:** A set of machinery is monitored to watch for changes in the operating sound.
 - If the measured sound exceeds the sound curve, it is an indication to the operator that “something bad” is happening (i.e., over exposure) and he needs to shut things down and call maintenance before more damage occurs.

Setting up captured curves

➤ Setting up Captured Curves Settings and measurement settings



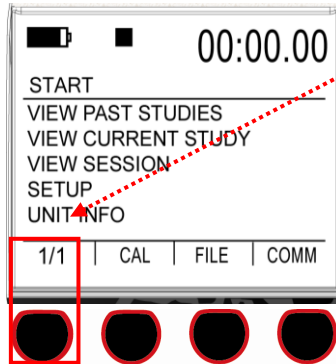



- From the start screen, select either 1/1 octave or 1/3 octave for the measurement type. (Repeatedly press first soft key.)



Selecting Measurement type

Press first soft key until 1/1 or 1/3 is selected

Figure 6-8: Selecting measurement type for curves

- Next, select the measurement type, by selecting **View Session** (use Up/Down Arrow to select) and press **Enter** . Select the appropriate meter 1 settings (using the soft keys) and set the response time, weighting, and measurement type. (See Figure 3-4 for an example).
 - NOTE:** It is recommended to set Meter 1 to **Slow response, Z-weighting**, and measurement to **Leq**.
- Press **On/Off/Esc**  to return to the start screen.
 - Select **Setup** (use up/down arrows to highlight) and press **Enter** .
 - Select **Options** menu (use up/down arrows to highlight) and press **Enter** .
 - Select **Curves** menu (use up/down arrows to highlight) and press **Enter** .
 - For the **Mode**, press **Enter**  repeatedly to select either **Survey** or **Evaluation** setting. (See explanation below).
 - **Survey Mode:** dynamically evaluates the noise and reports the appropriate noise curve. Typically used if you want to take multiple curve samples to evaluate and re-evaluate noise in a room/zone.
 - **Evaluation Mode:** evaluates the noise levels against specific criterion. This is primarily used when you are capturing one to four different curves. With this option, you assign a Capture name (**Cap-1, Cap-2, Cap-3, Cap-4**) in the setup menu and then run a captured curve study. To assign a new captured curve name, you return to the Options menu, select a name and then return back to view session mode and run your study.

- NOTE:** Whether you choose Survey or Evaluation mode, the captured curved results will report the same data. The survey mode is recommended for Captured Curves since it is slightly easier to use in the field.
7. Depending on your selection in step 4, refer to the following:
 - If **Survey Mode** was selected, please see step 6.
 - If **Evaluation mode** was selected, press **Up/Down ▲/▼** to highlight Criterion. Repeatedly press **Enter** to select Cap-1, Cap-2, Cap-3, Cap-4.
 8. Press **On/Off/Esc** twice to return to the start screen.

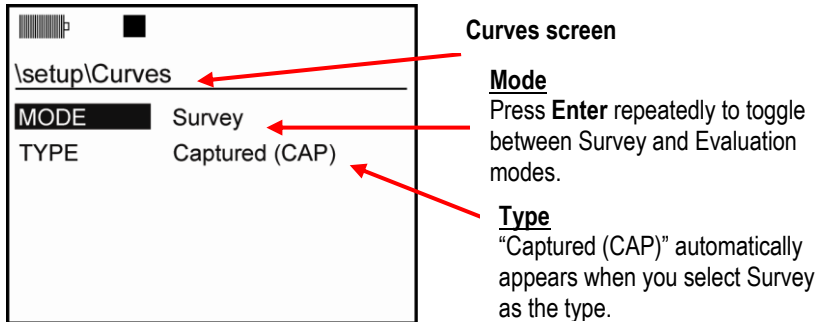

Figure 6-9: Captured Curves and Survey mode

Running captured curves

Capturing a curve allows you to take a snapshot of the current octave noise profile. Once the captured curve is selected and applied, the SoundPro Sound Level Meter will automatically calculate the captured curve results with the STI-PA measurement.

1. From the Start screen, select either 1/1 octave or 1/3 octave for the measurement type. (Repeatedly press first soft key.)

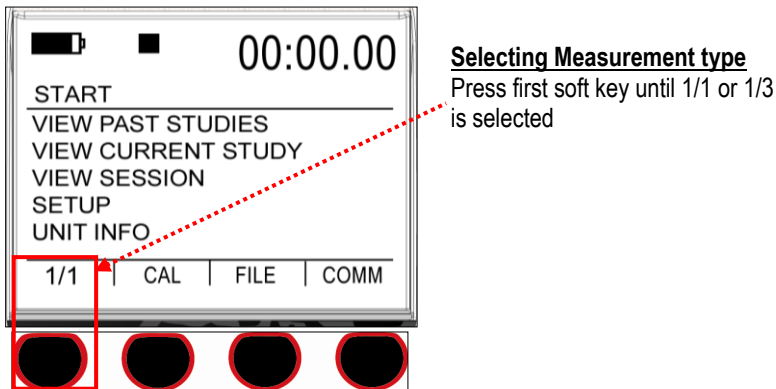
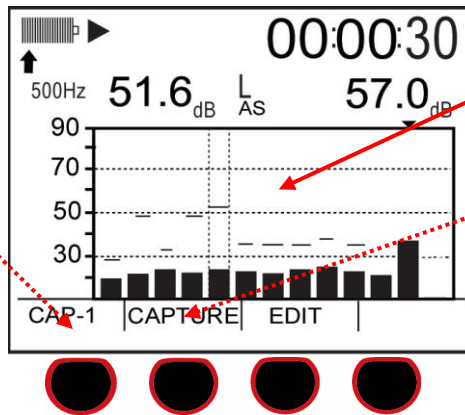

Figure 6-10: Selecting 1/1 or 1/3 for measurement type

2. To run a captured curve study, press **Up/Down** ▲/▼ to select (or highlight) **View Session** and press **Enter** ↵.
3. In the **View session screen**, select the appropriate meter 1 settings by using the corresponding soft keys for response time, weighting and measurement type (lookup key).
4. Press **Run** ⏸ to start your study. Depending on if you chose survey mode (see “a” below) or evaluation mode (see “b” below) in the setup screen, do one of the following:
 - a. **Survey mode:** When you are ready to capture a curve, press **AltF** key (on keypad) and the soft key menu will expand. Repeatedly press first soft key to assign a capture curve name (You have four options: Cap-1, Cap-2, Cap-3, or Cap-4). Then, to **Capture**, press the second soft key.

CAP-1

Press first soft key to assign a captured curve name (i.e., CAP-1, CAP-2, CAP-3, or CAP-4)



Curve indicator

Capture
Press **Capture**
soft key to Capture
a curve.

Figure 6-11: Capturing a curve (CAP-1)

- b. **Evaluation mode:** To capture a curve, the curve indicators will appear before and during your run. It will automatically save the run with curve indicators and assign the name you applied during the Options setup. To capture additional curves, assign a new name via the Options menu and then run another test. (See “Setting up Captured Curves” for details.)
5. To view your results, repeatedly press **Enter** ↵ (See section, “Running a curve study and viewing results.”)

Criterion curve families

Criterion curves is another option to display and record a selection of spectral curves for use in room and building acoustic measurements and noise control engineering. The objective of a criterion curve is to specify the ambient noise in a room or environment with a single number or statement, rather than individually specifying multiple octave or third-octave band limits (as you do with captured curves).

Types of Criterion Curves

The SoundPro Models SE/DL support a family of criterion curve families which are explained below. (For more information, please see glossary.)

- **Noise Criterion Curves (NC)** – uses a tangency method and is typically used for HVAC room or building acoustic comparisons.
- **Preferred Noise Criterion Curves (PNC)** – uses a tangency method but accounts for lower frequencies compared with the NC method.
- **Room Criterion Curves (RC)** – calculates a numerical rating based on speech interference and indicates any interference such as hissing, rumbling, or vibration. (This method was introduced to determine noise in offices/room acoustics.)
- **Balanced Noise Criterion Curves (NCB)** – are one of the newer methods that indicate interference from rumble, rattle, and hiss.
- **Noise Rating Curves (NR)** – used primarily in Europe, Australia, and other country's room and building acoustic measurements, HVAC studies, machine noise evaluations, and for some community noise enforcement applications.

Setting up criterion curves

Setting up criterion curves is similar to setting up captured curve parameters. However, with criterion curves, you select a specific curve type and then it is applied during your study (or test).

➤ Setting up criterion curves and appropriate measurement type

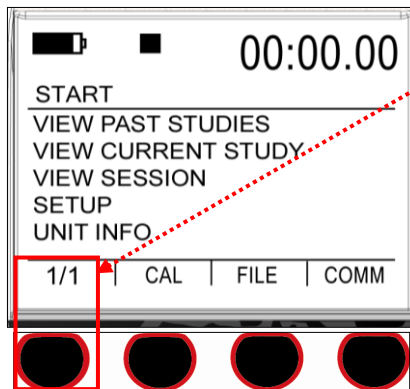

1. From the start screen, select either 1/1 octave or 1/3 octave for the measurement type. (Repeatedly press first soft key.)





Selecting Measurement type

Press first soft key until 1/1 or 1/3 is selected.

Figure 6-12: Selecting measurement type for curves

2. Next, select the measurement type, by selecting **View Session** (use Up/Down Arrow to select) and press **Enter** . Select the appropriate meter 1 settings (using the soft keys) and set the response time, weighting, and measurement type. (See Figure 3-4 for an example).
3. Press **On/Off/Esc**  to return to the start screen.

4. Select **Setup** (use up/down arrows to highlight) and press **Enter** .
5. Select **Options** menu (use up/down arrows to highlight) and press **Enter** .
6. Select **Curves** menu (use up/down arrows to highlight) and press **Enter** .

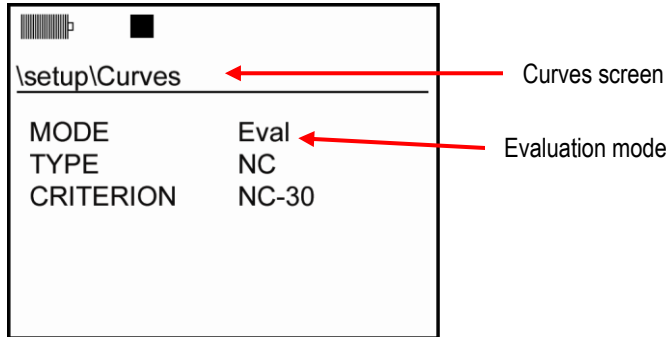





Figure 6-13: Curves setup screen example

7. For the **Mode**, press **Enter** repeatedly to select either **Survey** or **Evaluation** setting. (Please see explanation below).
 - **Survey Mode:** dynamically evaluates the noise and reports the appropriate noise curve. Typically used if you want to take multiple curve samples to evaluate and re-evaluate noise in a room/zone.
 - **Evaluation Mode:** evaluates the noise levels against specific criterion.
 - NOTE:** Whether you choose Survey or Evaluation mode, the criterion curved results will report the same data.
 8. Select a type by pressing **Up/Down** / to move to the Type field.
 9. Repeatedly press **Enter**  to toggle between the five-criterion curve options.
 - NOTE:** Depending on the Criterion curve you select, you may or may not have the option to set the Criterion field. If the Criterion field appears once you select the type, adjust this field by using the Up/Down arrows to move to the field and press **Enter** repeatedly to change the criterion.
 10. Press **On/Off/Esc**  twice to return to the start screen.
- To run your Curve study, please see section, "Running and viewing a curve study."

Audiometric background curves

The SoundPro SE/DL series supports the following two types of audiometric test room sound level curves:

- Audiometric Test Room Background Sound Level Curves (OSHA) which compares the ambient noise readings to the maximum permissible ambient noise levels (MPANLs) at 500 Hz, 1K, 4K, 8K as specified by the OSHA Hearing Conservation Amendment (1983).
- Audiometric Test Room Background Sound Level Curves (ANSI) which compares the ambient noise to selectable criteria specified in ANSI S3.1-1999 and allows for a variety of audiometric earphones using 1/1 and 1/3 octave band analysis.

Setting up audiometric background curves

For set-up parameters, it is recommended to set Meter 1 to Slow Response, Z-Weighting, and measurement to Leq before you run your study.

Additionally, the measurement type should be set to 1/1 octave for OSHA audiometric testing and should be set to 1/1 or 1/3 octave for ANSI audiometric testing. The steps below detail the procedures.

➤ Setting up audiometric background curves and measurement parameters

1. From the start screen, select either 1/1 octave or 1/3 octave for the measurement type. (Repeatedly press first soft key.)

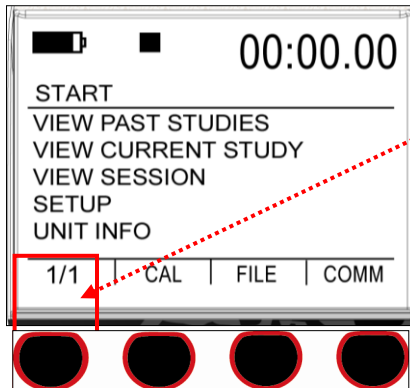

Selecting measurement type

Press first soft key until 1/1 or 1/3 is selected

Figure 6-14: 1/1 or 1/3 octave measurement type for audiometric testing

2. Next, select the measurement settings, by selecting **View Session** (use Up/Down Arrow to select) and press **Enter** .

3. Select the following recommended meter 1 settings using the soft keys using the soft keys: measurement to Leq, Slow response, and Z-weighting.
 - **Setting measurement to Leq:** Press the 1st soft key to access the “Lookup” menu. Using up/down arrows on the keypad, select “L_eq.” A diamond character ◆ indicates the “selected” measurement.
 - **Setting timed response:** Repeatedly press 2nd soft key to select appropriate setting (recommended is “S” for slow response.) An underline denotes the “selected” response.
 - **Setting Weighting:** Repeatedly press 3rd soft key to select appropriate setting (recommended is “Z” for Z-weighting).

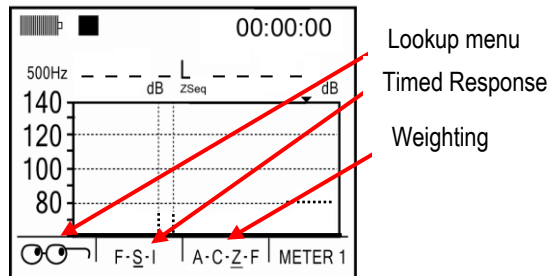

Figure 6-15: Selecting measurement type for curves

4. Press **On/Off/Esc** to return to the start screen.
5. Select **Setup** (use up/down arrows to highlight) and press **Enter** .
6. Select **Options** menu (use up/down arrows to highlight) and press **Enter** .
7. Select **Curves** menu (use up/down arrows to highlight) and press **Enter** .
8. For the **Mode** field, select **Eval** (“Evaluation”) by repeatedly pressing **Enter** .
9. For the **Type** field, select one of the following by pressing the down arrow to move to the type field and repeatedly press **Enter** .
 - ANSI AM Booth or OSHA AM Booth

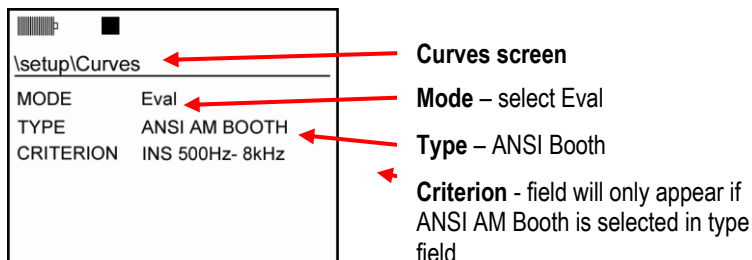



Figure 6-16: Audiometric booth setup in the curves screen

10. (Skip this step if you selected OSHA AM Booth). To select a Criterion, press the down arrow and repeatedly press **Enter** . You have the following three settings in the testing ranges of 125 Hz-kHz, 250 Hz – 8 kHz and 500 Hz-8 kHz octave or one-third octave bands.
 - **NC** refers to “not covered” ears in relation to a person in a hearing booth without the use of hearing protection.
 - **SA** refers to “Supra-aural” which is used when a persons is in a hearing booth with large headphones.
 - **INS** refers to “Insert” which is used when a person is in a hearing booth with ear inserts.
11. Press **On/Off/Esc**  twice to return to the start screen.
 - To run your Curve study, please see section, “Running and viewing a curve study.”

Running and viewing curves

After you have enabled curve mode, type, and criterion (only applicable for evaluation mode), you are now ready to run a curve study.

When viewing your measurements it is important to understand how your results will display. The following is an explanation of the curve types:

- If NC, PNC, NR, NCB, or RC are selected these will display in 1/1 octave only.
- If Captured Curves are selected, this will display in 1/1 octave or 1/3 octave.
- If OSHA Audiometric is selected, it will display in 1/1 octave only. If ANSI Audiometric is selected, it will display in 1/1 octave or 1/3 octave.

Curve measurements and results

➤ Running a curve study and viewing results

1. From the Start screen, ensure you are in 1/1 or 1/3 mode. Then, press the **Up/Down** arrows until “**View Session**” is highlighted.
2. Press the **▶ Run** key to begin your study. When completed, press pause and stop keys to end the session.

3. To view your results, press **Enter** (↵). The following screens appear.
 - (a) **Sample bar chart** – displays 1/1 octave band with curve and sound values plotted on the spectrum. (See “a” below: A- selected band, B- curve indicator, C- amplitude in band.)
 - (b) **Tabular screen** – shows 1/1 octave band values in a table format (see “b” below).
 - (c) **Community noise** – displays community noise (see “Community Noise screen” for a screen example).

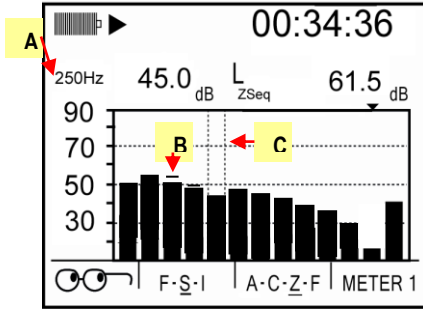

(a) Sample bar chart with curves

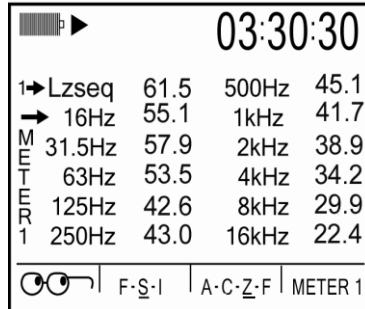

(b) Tabulation screen

- (d) **Dosimetry screen** - shows dosimetry measurements (see “e” below).
- (e) **Delta screen** – displays difference between the selected curve and current measurement, in each filter band. A positive value is the amount exceeding the curve (see “(e) Delta screen” and reference “A” in the figure) and a negative value is the amount below the curve.

NOTE: For a captured curve, it will display CAP-1(or applied captured 1-4) in the top left instead of a criterion curve (NC-30). You may have to select LEQ to view the results via the Look-up key.

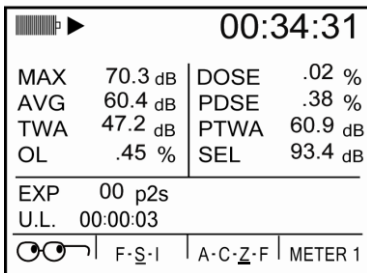

(d) Dosimetry screen

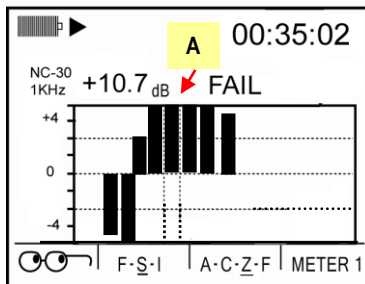

(e) Delta screen

Figure 6-17: Curve results

Speech Intelligibility

Another available add-on feature is Speech Transmission Index (STI) used to evaluate and classify speech intelligibility dependent of background noise level. STI is the standardized measurement in the IEC 60268-16:1998 standard.

STI-PA testing

STI refers to the amount of modulation preserved in the broadcasting of an artificial speech signal through an alarm system. The intelligibility measurement is a single value between zero and one, which factors in corruption of speech, with modulating speech frequencies over octave bands between 125 Hz to 8 kHz.

STI-PA is measured using seven octave bands and two modulation indices per octave band simultaneously allowing a 15-second measurement. In essence, any noise which masks (or corrupts) the talker-to-listener path is evaluated and a recommended measurement is computed at the end of an intelligibility test. The following sections briefly address points to consider when setting up a STI-PA test.

Zones

Where do I measure speech intelligibility? A building or stadium can be broken into “zones.” Each “zone” has a room with one alarm system. In some situations, one room may have more than one alarm system or may have a change in ceiling height (such as an atrium or a balcony seating versus lower level seating). In those instances, each section would be considered a zone and each zone would be tested. After determining the “zones” in your building, it is recommended to design a map of the key zones/rooms. Generally, a zone is a 20 x 20 area. If the room is larger than 20 x 20, it is recommended to take another measurement in this section.

Selecting STI scale or CIS scale

With the SoundPro Sound Level Meter, you have two measurement options which will determine the intelligibility of your building which are the STI scale and the CIS scale (explained below.)

STI scale

The scale identifies if the mass notification system is intelligible or unintelligible based on a **STI scale** ranging from 0.0 to 1.0 where **0.5 to 1.0** is considered a passing score, per NFPA 72 and IEC 60849.

STI Scale	00 - 0.30	0.3 - 0.45	0.45 - 0.60	0.60 - 0.75	0.75 - 1.00
	Unacceptable	Poor	Fair	Good	Excellent

Common Intelligibility Scale (CIS)

Similar to the STI scale, the CIS scale uses a range from 0.0 to 1.0 to determine if the MNS is intelligible. However, with the **CIS scale**, a rating of **0.7 to 1.0** is an “intelligible” score, per the IEC 608489 and NFPA 72.

STI Scale	00-0.48	0.48 - 0.65	0.65 - 0.78	0.78 - 0.88	0.88 - 1.0
	Bad	Poor	Fair	Good	Excellent

When to take STI-PA readings?

Scenario one

You may be able to run the test signal through the PA system during normal business hours. In this scenario, you would set the meter to STI-PA and select either STI scale or CIS scale and run your study in the mapped “zone” areas.

Scenario two

In other situations, running a test tone through a PA system during business hours could be distracting and not feasible for your environment. In this situation, it is recommended to follow these procedures:

- **First**, take sample background noise measurements during business hours. These are saved and stored on the Verifier as “Captured Curves.” The verifier will save up to four “captured curves”
- **Second**, in the STI-PA options, select the appropriate captured curve.
- **Third**, run your measurements at the appropriate time of day (i.e., late evening/early morning). (The applied captured curve will automatically factor into your study.)
- **Fourth**, view your results on the display of the instrument (or in Microsoft® Excel® spreadsheet program by using the File converter tool.)

Conducting a STI-PA test (overview of steps)

1. Calibrate the SoundPro Sound Level Meter.
2. Set-up your STI-PA options via the “Measures” setup screen. (Select the measurement type as STI-PA.)
3. A level setup is conducted. From a fixed-point, the technician measures the A-weighted SPL of MNS message (or alarm system). The test signal volume should approximately match the MNS message volume. (You would adjust the test signal to match the L_{AS} value.)
4. The test signal is played through buildings voice system (PA system).
5. The technician/sound tester positions himself/herself in “zones”/building areas.
 - It is recommended to design a map of “zones” (or rooms) to indicate where you will be taking your measurements.
 - Set measuring range appropriately.
6. STI-PA measurement is conducted. Press the **Run/Pause** key to start the study.
 - ☑ **NOTE:** If you want to post-process your intelligibility measurements with previously captured background noise, you would first capture curves and then apply this during your study.
7. After a 15-second countdown, either a STI or CIS level is displayed with a pass/fail message.
8. The technician/sound tester moves throughout the building and measures in all zones/rooms.
 - ☑ **NOTE:** A zone/room is typically a room 20 x 20. More than one measurement may be required if the room exceeds this size.
9. The tests are noted as pass/fail.
 - ☑ **NOTE:** the past tests can be reviewed and loaded via the File System screen.

STI-PA setup

The following table explains all of the parameters found in the measures setup screen.

Measures setup screen	Explanation
Scale type field	Select either STI scale or CIS scale. (Please refer to Chapter 1, “STI scale or CIS scale”)
Gender field	The voice can be set according to the test signal being use, male or female voice. The Verifier default setting is Male. If using the test signal supplied by TSI, this uses a male test signal; so; you will not have to change this field if you only use the male test tone signal.
Post Process field	An optional “ captured curve ” feature can be applied to your STI-PA testing. Essentially, you take a snap shot of the current sound level measurement and store it as your background noise. Once the background noise data is gathered, you can apply the captured noise during your STI-PA measurement. This may be used in a situation where you cannot play the test signal during “normal” working hours. (Please refer to Chapter 1, “When to take STI-PA measurements, scenario 2” for more details.)
Range field	You can change the range when measuring. The following ranges are selectable parameters: 90 dB – 140 dB, 80 dB – 130 dB, 70 dB -120 dB ,60 dB – 110 dB, 50 dB – 100 dB, 40 dB – 90 dB, 30 dB- 80 dB, and 20 dB – 70 dB.

Table 6-3: Measures setup screen parameters explained

➤ Setting up STI-PA (speech intelligibility)

1. Turn the meter **On**.
2. From the Start screen, select the Measurement type as **STI-PA**.
 - Press the first soft key repeatedly until “**STI-PA**” appears.

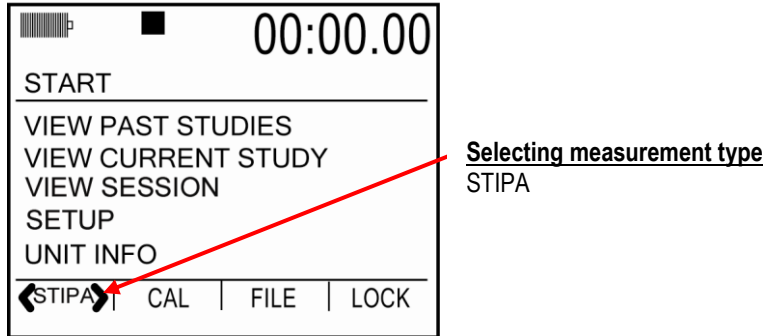





Figure 6-18: Measurement type selection (STIPA)

3. Using **Up/Down** arrows, highlight **Setup** menu and press **Enter** .
4. Using **Up/Down** arrows, highlight **Options** and press **Enter** .
5. Press **Up/Down** arrows, to select **Speech** Intelligibility and press **Enter** .
6. To change the **Scale** field, press **Up/Down** arrows until **Scale** is highlighted and press **Enter**  to change to either **STI** or **CIS**.

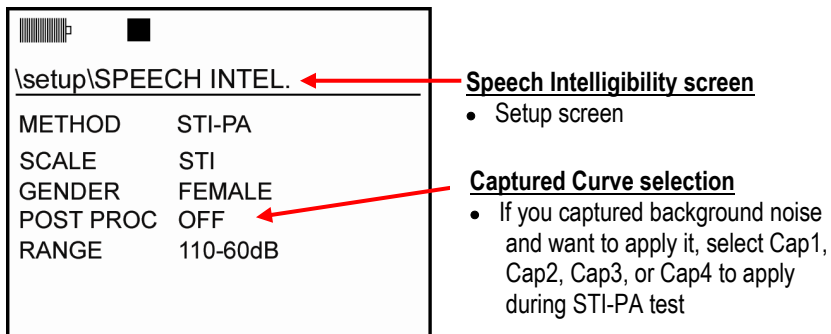





Figure 6-19: STI-PA setup screen

7. To change the **Gender** field, press **Up/Down** arrows until **Gender** is highlighted and repeatedly press **Enter**  to select **Male** or **Female**.
8. To change the **Post Processing** field, press **Up/Down** arrows to select the field and repeatedly press **Enter**  to select a **Captured Curve** or **Off**.

9. To change the **Range**, press **Down** arrow and then repeatedly press **Enter**  to select a specific range.
10. Once set, press **Enter**  to return to the Start screen.

Conducting a level setup (for STI-PA)

From a fixed-point, measure the A-weighted Sound Pressure Level of your mass notification system (or alarm system). When in the STI-PA screen, adjust the range as needed via the Up/Down Arrows.

- The average dB level is displayed when in stop mode.
- NOTE:** The instrument will display the L_{AS} when in stop mode. This is also called “survey mode.”

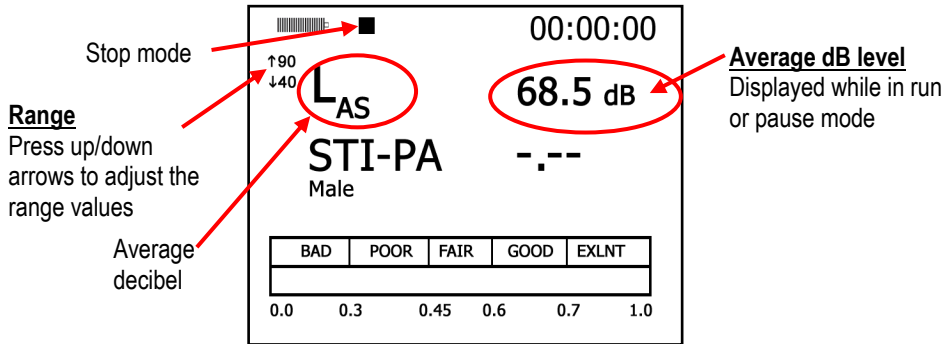

Figure 6-20: Level set-up and average decibel level

Running a speech intelligibility study

Before proceeding with a STI-PA measurement, ensure you calibrated the Verifier and conducted a Sound Level setup.



- NOTE:** If there is impulsive noise present, it is best to capture the background noise (via the Captured Curve pop-menu), remove the noise, or come back later when the noise is not present. That is because impulsive noise and strong voices can skew the measurement results. If you captured the background noise, you would then come back when the noise is not present and apply the captured curve during a STI-PA measurement. (See “Applying captured curves for STI-PA testing for more details.”)

The following instructions explain how to run, pause, and stop a STI-PA study without captured curves. (If you want to take a background noise sample, also called “captured curves see “Applying captured curves for STI-PA testing” for more details.)

- NOTE:** It is optional to organize your measurements into Sessions & Studies.

➤ How to run a STI-PA study?

1. The SoundPro meter should be powered on and you should be viewing the **STI-PA measurement screen**.
2. Play the signal over the loudspeaker and then locate yourself in the appropriate **zone/room**.

3. Verify that the range setting is appropriate for the level being measured. It is desirable to select the longest range that does not overload. (To change the range, press **Up/Down** arrows from the STI-PA screen.)
4. Press the **Run**  key to begin your study.
5. The meter will **run for 15 seconds** and then pause.
 - To continue to take measurements, repeat step 3.
 - To terminate your study, please see step 6.
6. Press the **Stop**  key to end your study. (Three viewable results screens are explained in the next section.)

STI-PA results screens

The test signal is made up of seven octave band signals which encompasses a combination of vowels and syllables from common speech. There are 14 modulating frequencies that emulate a male/female's speech patterns. The STI method is based on the determination of the modulation transfer function (MTF) which is the ratio of measured modulation to the overall signal strength at each modulation frequency.

➤ Viewing STI-PA results

1. Once in pause or review mode, press  repeatedly to toggle through the STI-PA results screen.

STI-PA measurement and scale results screen

In the **STI-PA measurement screen**, the MTF is combined according to IEC 60268-16 and presented on a scale between 0 to 1 representing the quality or intelligibility of the mass notification system.

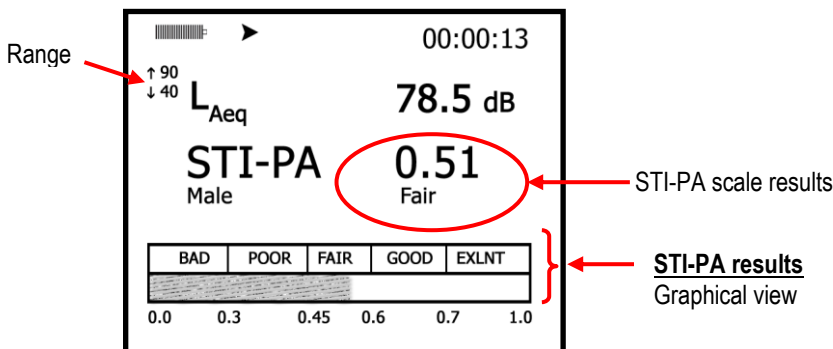

Figure 6-21: STI-PA measurement (scale results) screen

STI-PA modulation screen

In the **Modulation measurement screen**, the average decibel level over the run-time in seven octave bands ranging from 125 HZ to 8 kHz with 14 frequencies is displayed in a tabular format. These values are the signal to noise ratio (accounts for any interfering background noise such as non-linear distortions,

electronics, reverberation, HVAC systems) in each attenuation band and indicates which values are intelligible/unintelligible based on the CIS/STI scale.

NOTE: A high MTF value indicates that the listeners received the message without any distortions or interference.

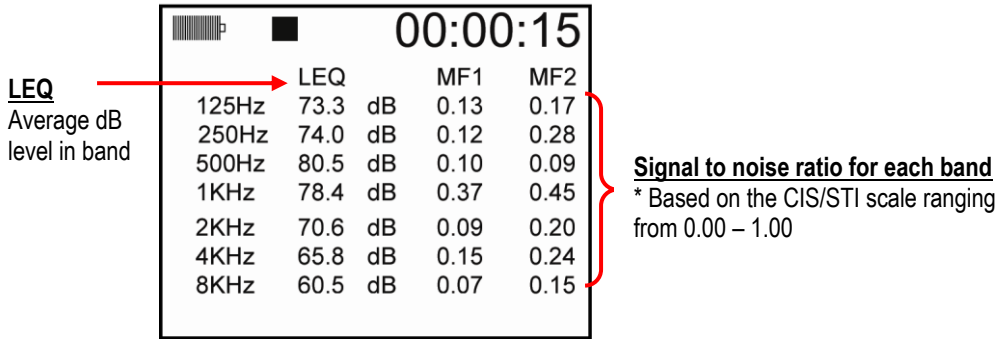

Figure 6-22: STI-PA Modulation screen

Table 6-4 defines the STI-PA: modulation frequencies for the seven octave bands (per the IEC 60268-16 standard).

Octave band Hz	125-250	500	1 k	2 k	4 k	8 k
First modulation frequency Hz	1.00	.63	2.00	1.25	0.80	2.50
Second modulation frequency Hz	5.00	3.15	10.0	6.25	4.00	12.5

Table 6-5 defines the STI octave band with specific male and female weighting factors used with STI-PA measurements (per the IEC 60268-16 standard).

Octave band Hz	125-250	500	1 k	2 k	4 k	8 k
Males	0.127	0.230	0.233	0.309	0.224	0.173
	0.078	0.065	0.011	0.047	0.095	—
Females	0.117	0.223	0.216	0.328	0.250	0.194
	0.099	0.066	0.062	0.025	0.076	—

STI-PA modulation envelope screen

This screen reports a summary of the STI-PA modulation screen.

- To view each band's results, press ◀/▶ **Arrow** key.

NOTE: The results can be used to assess each frequency's band modulation level to determine why it passed or failed (in order to correct any issues).

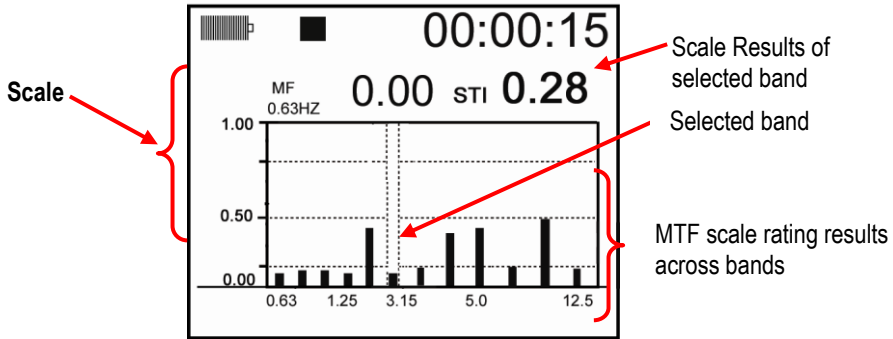

Figure 6-23: STI-PA Modulation envelope screen

Storing background noise/capture curve

In order to measure and store background noise prior to STI-PA testing, you will want to measure (or “capture”) the level via the Captured Curve Setup and then apply it during the STI-PA test.

NOTE: This is only performed if you do not want to play the test tone during “normal” business hours.

- From the Start screen, select either **1/1 octave** or **1/3 octave** for the measurement type.

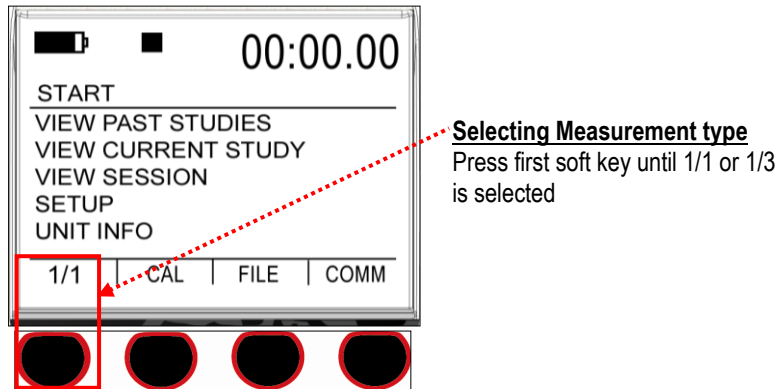
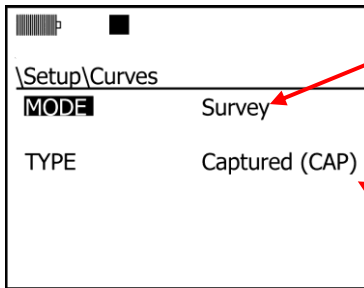

Figure 6-24: Selecting 1/1 or 1/3 for measurement type

2. **Setting up Curves:** Select **Setup** and press **Enter** (↵).
 - Select **Options** (via the **Down Arrow** and press **Enter** (↵)).
 - Curves will be highlighted, press **Enter** (↵).
 - Choose **Survey** as the Mode and **Captured (CAP)** as the Type and then press **On/Off/Esc** repeatedly to return to the **Start** screen.



Mode

When highlighted, press Enter continuously to toggle through the menu options and select **Survey**.

NOTE: Survey/Eval. mode will compute the same results.

Captured (CAP)

To select the Type field press down arrow. Press **Enter** repeatedly to select **Captured (CAP)**.

Figure 6-25: Captured curve/background noise setup for STI-PA testing

3. Capturing curve/background noise: (See Figure 6-26 below.)
 - Select **View Session** by pressing **Up/Down** ▲/▼ and press **Enter** (↵).
 - **NOTE:** It is recommended to capture either the **SPL** or the **Leq** level. To change the measurement displayed, press the **Lookup** soft key and select either L_ or L_eq. (For more information, please see “Changing displayed measurements.”)

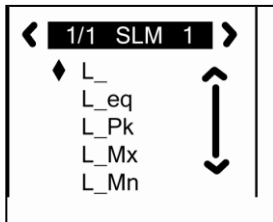

Selection Panel

This appears when lookup soft key is pressed.

- The diamond symbol ◆ indicates which measurement is selected. (L_ denotes SPL). Press **Enter** key to confirm new selection.

- In the **broadband/RTA** screen, press **AltF** key. (This will expand the soft keys and Cap will appear.)
- When the level is stabilized, press the **“Capture”** key. (See Figure 6-26.)

4. *Optional:* To capture additional background levels, change the 1st soft key to either (Cap-1, Cap-2, Cap-3, Cap-4) and then press the Capture (2nd) soft key. Repeat this step as needed. (You can store and apply up to 4 background noise SPL levels.)

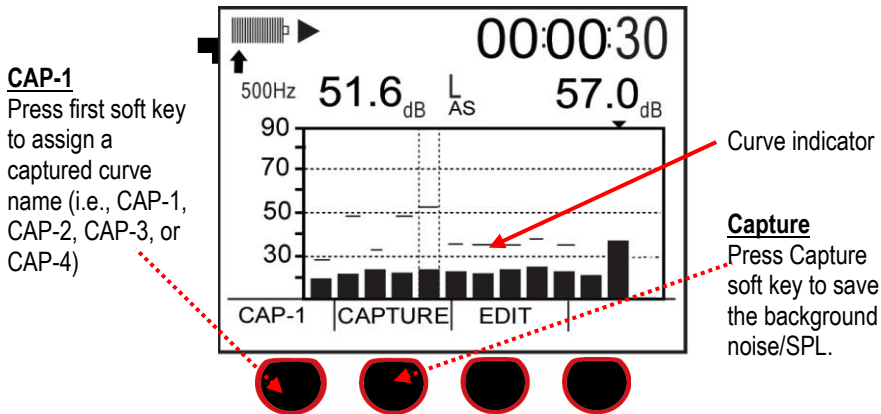

Figure 6-26: Captured curves/background noise

5. Once all background noise has been captured, refer to, “Applying captured curves” below.

Applying captured curves for STI-PA testing

To apply the curves during a STI-PA measurement remember to complete one and two below before applying the curve.

➤ Applying captured curves

1. From the **Start** screen, select **View Session** and press . Press **AltF** key.
2. Select one of the captured curves by pressing the 1st soft key (i.e., Cap-1). Press **On/Off/Esc** key.
3. From the **Start** screen, press the 1st **soft key** continuously until **STI-PA** is selected. Then, select **View Session** and the STI-PA screen will open.



POST CAP-1

The selected Captured Curve, i.e., CAP-1, will appear on the STI-PA screen. To change the Cap-x, repeat steps 1-2 above.

Figure 6-27: Post CAP-1 applied during STI-PA test

4. Press the **Run/Stop** key while playing the test signal in the appropriate location/zone. The captured curve will automatically calculate with the STI-PA results.
 NOTE: Press the left/right arrow to view the modulation screen and/or the modulation envelope screen if desired.



(This page intentionally left blank)

Viewing Past Measurements

This chapter explains how to view your past sessions and studies. It will also explain how to rename your sessions/studies and how to clear/reset the data on the memory card.

Files

A session file is automatically created when you begin the first study in that session. It contains the following types of information, as applicable:

- **Measurements** - Measurements for each study in the session and overall measurements for the session.
- **Run times** - Run time for each study in the session and overall for the session. If back-erasing was used for a study (“Back-erasing”), the run time for that study will be reduced by the duration of the back-erased segment.
- **Analysis type** - The analysis type selection, if available in your instrument that applied when the measurements were made.
- **Calibrations** - If performed, Pre-Calibration results for the session and Post-Calibration results for studies in the session.
- **Logged data** - Stored with the session if the instrument contains the logging option and logging was enabled for at least one measurement.
- **Parameters** - All user-adjustable settings in setup screens that are involved in the data processing that leads to the measurements.
- **Instrument settings** - All user-adjustable settings in setup screens that affect the operation of the instrument, but not including those in the Time- Date, Sig. Input and Battery Check screens.

File directories

Files on the memory card are stored in directories. Session files are automatically stored in the Session Directory, and Configuration Files are automatically stored in the Configuration Directory. The File directories screen can be used to:

- View past sessions/studies via the Session Directory menu
- View Configuration directory
- Re-name last session file is an optional feature that is used as an organizational tool.
- Save Configuration file is used to save a customized setup on the instrument if not using QSP-II.

CAUTION: DO NOT insert or remove the memory card when working in the instrument’s file system – you can lose data.

File directory screen explained

- ☑ **NOTE:** this is accessible when a session is not opened (i.e., run /pause mode).
1. From the Start screen, press the **File** soft key. The **File** screen appears.
 2. In the File screen, select **Session Directory** or **Configuration Directory**, then press . The directory that you requested appears.

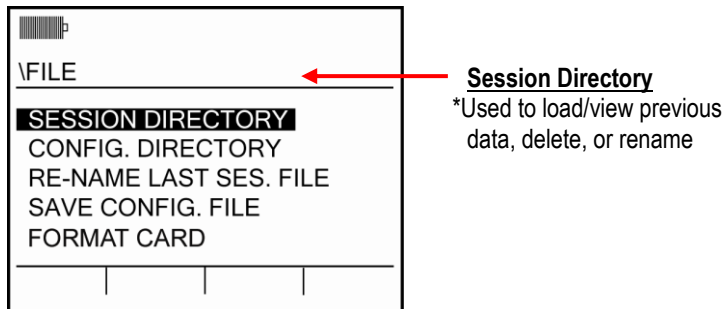

Figure 7-1: File Screen

Viewing past sessions/studies (review mode)

Once you run, pause, and stop your measurements, the data is automatically stored in the instrument's memory card, which is referred to as past studies or past sessions. You can view past measurements by first loading the study or session via the Data File screen. The results will be played back (also called review mode) in accordance with the analysis type that was selected when the measurements were stored.

1. From the **Start screen**, press the **File** soft key.

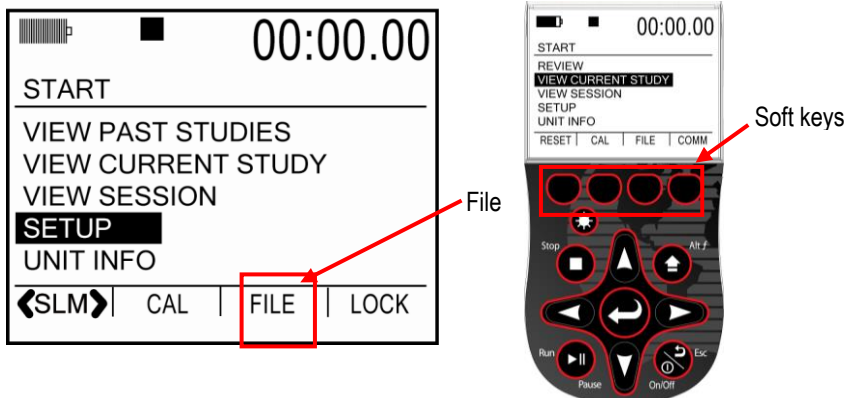

Figure 7-2: Start menu screen

2. **Session Directory** will be highlighted, press **Enter** (↵).

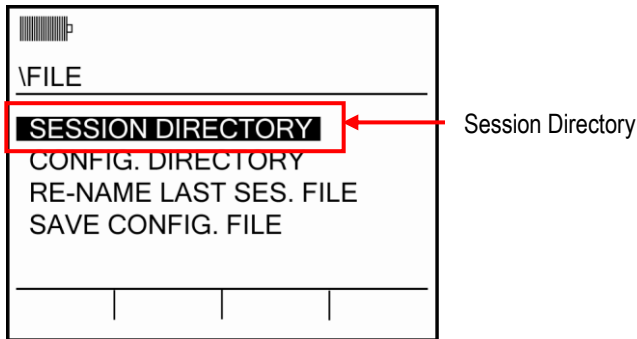

Figure 7-3: File menu screen

3. In the **Data File** screen, press **▲/▼ Arrows** to select one of the saved sessions and press **Enter** (↵) (to load the file).

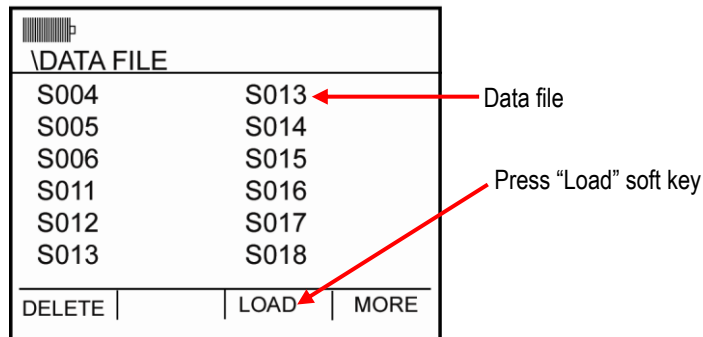



Figure 7-4: Data File screen

4. It will state "Loaded." Press either **Enter**  or **On/Off/Esc** key.
5. In the **Start** screen, the review indicator appears. Select either **View Session** or **View Current Study** (by pressing **▲/▼** and .

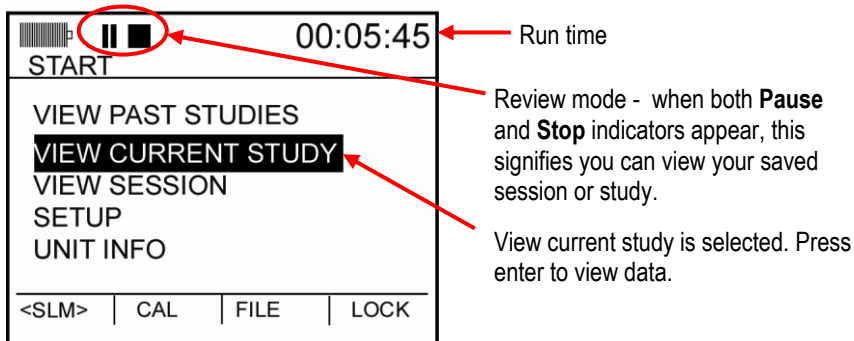



Figure 7-5: Selecting past study data (review mode)

6. A bar chart or a filtered bar chart may appear (depending on your measurement setting). Press **Enter**  to view various measurement screens.

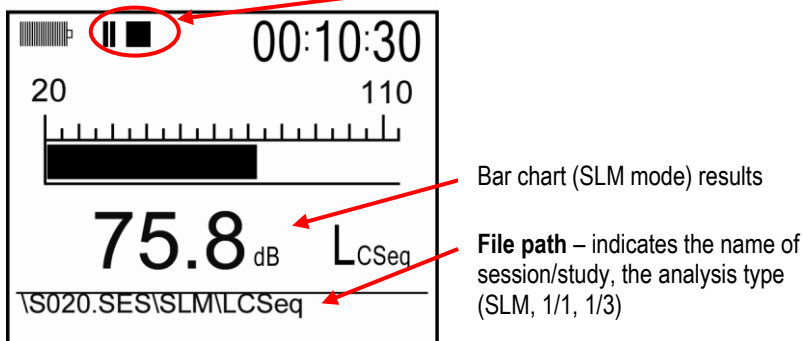

Figure 7-6: Viewing past data example

7. Press **Stop** key to exit Review Mode. (The Pause icon will disappear leaving only the Stop indicator displayed on your screen.)

Loading and deleting files

As you are working with loading past files and possibly deleting files which have been imported into QSP-II, it is important to note that the delete operations take place as soon as you press the respective soft key. While you can re-load a file, you cannot un-delete a file, so be careful. (Loading and deleting files is accessed via the File soft key\Session Directory menu.)

➤ Loading or deleting a file

1. From the start screen, press the **File** soft key.
2. In the **File** menu, ensure **Session Directory** is highlighted (if it is not, press ▲/▼ until it is selected.) Press ⏪ key.
3. To **load a file**, press ▲/▼ to select the appropriate file and press **Load** soft key (see “b”) or press ⏪ key (skip this step if you are deleting a file).
4. To delete a file (if not applicable see step five), press ▲/▼ to select appropriate file and press **Delete** soft key (see “a”). (The display will state the file was deleted.) Press ⏪ key to return to the Data File screen. To delete more files, repeat this step. Press ⏪ repeatedly to return to the start screen.

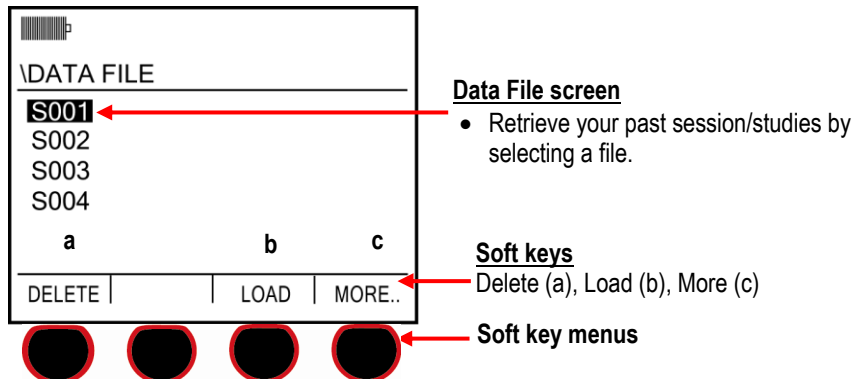

Figure 7-7: Loading and deleting files

☑ **NOTE:** You may have dozens of files saved. Press the **More** soft key to expand the file list for the appropriate selection.

5. If you loaded a file, please see next section, “Viewing past sessions/studies.”

Session directory

The Session Directory contains the past saved sessions and studies. To navigate to this screen, select Setup\File soft key\Session Directory menu. (Refer to Figure 7-2 and Figure 7-3 for screen examples.)

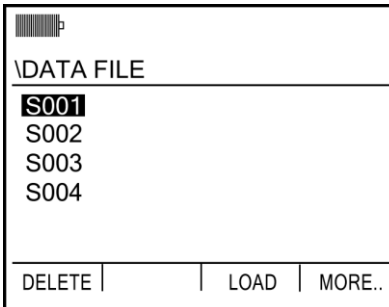



Figure 7-8: Examples of directory screens

Navigating in a session/config. directory

Press any arrow key to move around in the directory. If there are multiple files, press the **More** soft key to navigate to additional screens. Press **On/Off/Esc**  key to return to previous screen(s).

Naming and renaming files

There are common procedures that you can use to name and rename files, including a lookup capability that allows you to determine if a filename is already in use.

You cannot rename a session file unless it is in the instrument's memory. Accordingly, you can rename the closed session currently residing in memory, but you must first load a past session file before you can rename it.

☑ **NOTE:** For past sessions, please follow these steps but first load the file.

➤ Renaming the session in memory

1. In the Start screen, press the **File** soft key. The File screen appears.
2. Press **▲/▼** to select **Re-name Last Session File**, then press **↩**.
The session file renaming screen appears.
3. In the File Name screen, press **↩** and the following changes will occur:
 - The highlighted cursor moves to the field of one of the four soft keys, depending upon the last character in the existing filename.
 - The last character in the filename is underlined.

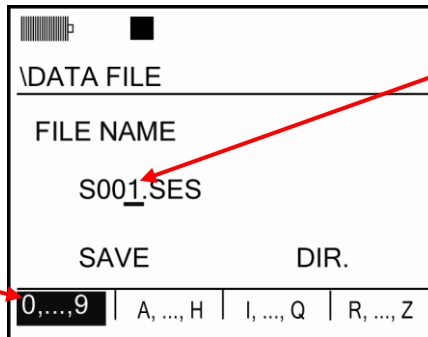

- Soft keys may be used to quickly select a letter/number character.
- Or repeatedly press **Up/Down** arrows to select appropriate character.



- Press **Enter** to add another field.
- Press **Up/Down** arrows to change character

Figure 7-9: Naming a file in the Data File screen

4. Take the following actions to change the underlined character:
 - Press **▲/▼** to move sequentially until the appropriate character is selected. The underlined character in the name changes as you press the keys.
 - (*Optional Shortcut*): Press a soft key to select a different character set.
 - Add a character by pressing the **right arrow** key.
 - Delete a character by pressing the **left arrow** key.
 - Repeat this step as necessary.

5. When finished, press  and **Save** will appear.
6. Press  to save the file name (or press **On/Off/Esc** to cancel).

Configuration directory

File Setups, or File Configurations, can be saved to the instrument in order to save and reuse for future. (This can also be performed via QSP-II when you save a setup.)

The **naming/renaming** procedure below includes a lookup utility that you can use to determine what name to assign.

Saving (& naming) setup file (config. file)

When saving a setup, you first select the settings and then save via the **Save Config File** (accessed from the File soft key in the start menu.) Once a configuration is saved, you can view or delete it via the Config. Directory.

➤ Naming and Saving set-up

1. Ensure the SoundPro meter is in **Stop** mode and the parameters are selected. (See Chapter 3 and Chapter 4 for details.)
2. In the **Start** screen, press the **File** soft key and select **Save Config. File**.
3. In the **Setup File** screen, press  to move to the name/rename file field.

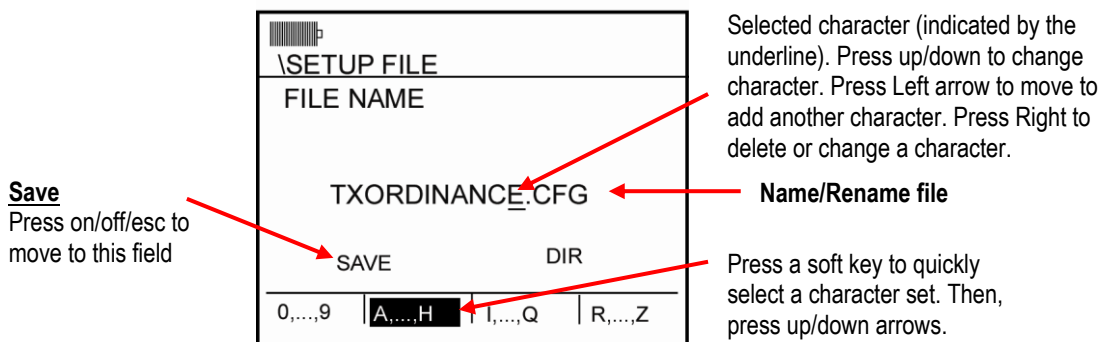

Figure 7-10: Saving/Creating setup file (config. file)

4. To change the file name follow below:
 - Press **▲/▼** to change the selected character (denoted by the underline).
 - *Optional Shortcut:* press a soft key (has a character range) and then press **▲/▼** to quickly move to the appropriate value.
 - Press **Left** arrow to delete a character (or move backwards).
 - Press **Right** arrow to add a character.
 - Repeat as necessary.

- To save your setup, press the **On/Off/Esc** and the Save option will be highlighted. Press **Enter** key to save (or press **On/Off/Esc** key to cancel).

Viewing, loading, deleting setup files (config.)

➤ Viewing, loading, deleting setup files

- Open the Configuration Directory screen (follow steps 1-2 above, "Saving setup file").
- The **Setup File** screen will appear. Depending on what setups you saved, these will appear in this screen.
- To **Load** or **Delete** a file configuration, do the following:
 - Select a file you want to load/delete (by pressing up/down arrow until selected.)
 - Once selected, press either the Load soft key (to load and apply the saved setup) or press **Delete** (to delete a setup).
 - Press **On/Off/Esc** to repeatedly to return to the Start screen.

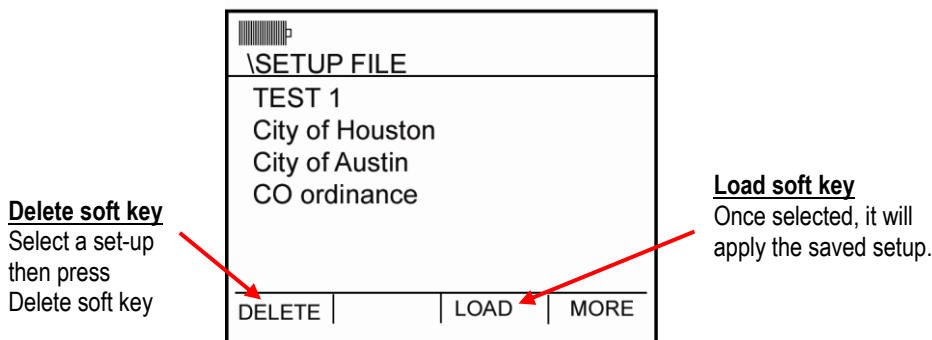

Figure 7-11: Viewing, loading, deleting setup files

Memory card

The memory card supplied with the instrument is used to store session and configuration files. If you run studies and sessions without a memory card, it will not store session files. In that case, running a session will automatically overwrite the information in the instrument's memory from the previous session. Essentially, lack of a memory card converts a multi-session instrument into a single session instrument.

Compatibility

Steps have been taken to make sure the SoundPro meter is compatible with as many SD cards as possible. Because of the many SD card manufacturers and the varying low-level formats they use, TSI can only guarantee operation with cards available from TSI. If using a memory card with 2GB or less, FAT 16 format is required. For cards ranging from 2GB to 32GB, a FAT 32 format is required.

➤ Determining the format of an SD card

1. Insert the card in the computer's card reader drive.
2. Open Windows® Explorer®.
3. Right-click on the CD drive listed under **My Computer**.
4. From the right-click menu, select **Properties**.
5. On the **General** tab, the File System field identifies the card's format.

Formatting a card with the SoundPro Sound Level Meter

The SoundPro meter has the capability of doing a **Quick Format** or **Full Format**. A **Quick Format** is all that is required in most cases to format a card in FAT 16 or FAT 32. A **Full Format** will verify each sector of the card as it formats with the penalty of taking much longer.

CAUTION: A **Quick Format** may be used to delete all files from the card.

Communicating

This chapter covers issues related to the memory card, the USB port and the AC/DC outputs.

Communicating with a PC

Using Detection Management Software DMS

When you download the data via the the download feature, the data is stored and viewable via the data finder page with advanced charting, tables, and reporting capability. The information is viewed in customizable graphs and/or charts in the panel layout page.

Using an external card reader

DMS can import data/configurations with an external SD card reader. You should never remove a card from a reader without first ejecting it from the drive. Eject using the following Windows® procedure.

➤ Eject procedure

1. In the computer, right-click the Removable Disk entry under **My Computer**. A menu appears.
2. Click **Eject** in the right-click menu.

Working with measurement data in DMS

The downloading of data enables you to analyze your data in customizable charts and graphs with reporting capability with optional reporting capability.

- NOTE:** Reference the online DMS User Manual under Help menu, DMS user manual for more information.

DMS and working with SoundPro data

➤ Viewing data and Data Finder Page

1. Communicating/connecting the SoundPro meter to the PC

- A. Turn On  the Sound Pro meter.
- B. Plug in USB cable from SoundPro meter to PC.



3. SoundPro meter and downloading

- A. Select the SLM family and the SoundPro mode from the Instrument window (see **A**). Click on “Go to session finder after download” box.
- B. Click the  button (See **B**).
- C. Once downloaded, click the **Data Finder** tab (if you did not select “go to session finder in step A”). (See **C**).

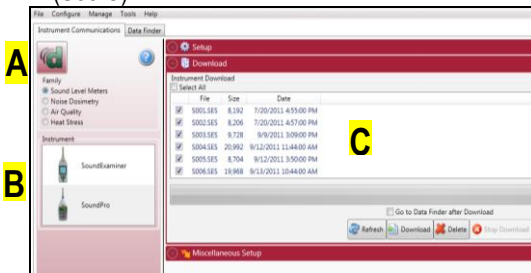

5. Viewing Data in graphs & tables & Report View

The graphs and tables page is noted as the panel layout view page.



- A. The session/study data page displays the data in logged data charts/tables (see **A**).
- B. Click on  to view the panels in a report format (see **B**).

2. DMS Welcome page and instrument communication

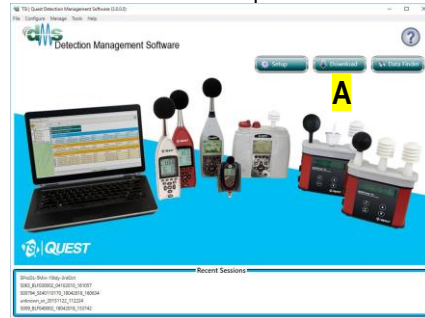
- A. Click on  (see **A**) to access the Instrument download panel.



4. Selecting and viewing data

- A. The Data Finder page (see **A**) is used to view, select, and preview reports. **NOTE:** Click **Browse** to view all data files.
- B. Select the data by clicking on either the session/study (**NOTE:** You may need to expand to see the study data).
- C. To view in Graphs and Tables, click on  or  buttons.

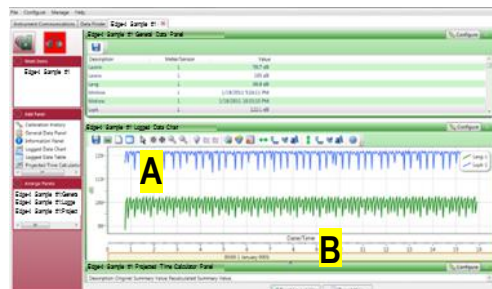

AC/DC output

Output signals are available at the AC/DC jack in the hardware interface panel at the base of the instrument ("Hardware interfaces"). Users are responsible for providing the cable to attach to this jack. For information about the pinout, see "AC/DC jack."

AC output

The AC output is the amplified SPL of Meter 1. It is weighted depending on the "A, C, Z or F" selection for Meter 1. The maximum full-scale output voltage occurs near the upper dB level of the selected range and is approximately 3.16 volts "before clipping." The full usable range of this output is 60 dB. The relationship is shown in Table 8-1.

Relative dB	Output (Vrms)
Full scale	3.16
-10 dB	1.00
-20 dB	0.316
-30 dB	0.100
-40 dB	0.0316
-50 dB	0.0100
-60 dB	0.00316

Table 8-1: AC output

NOTE: The AC output signal is not intended to be used for testing instrument performance.

DC output

The DC output has a voltage range between 0 and 4.0 VDC that is produced by Meter 1 and includes the time response and frequency weighting settings for that meter. It represents and tracks the displayed dB level in one second increments. The DC output is linearly scaled over the range of -20 to 180 decibels. The highest level that can be represented on any selected range is always the ceiling of that range and depends upon the selected microphone model.

The DC output voltage level is related to the measured decibel value without regard to the range setting. You can calculate the SPL in decibels from the DC output voltage, V_{DC} , by this equation:

$$\text{SPL} = 50 (V_{DC} - 0.4)$$

(This page intentionally left blank)

Specifications

Conformance to standards

Acoustics

IEC 61672-1 (2003) (2002-05) - Electroacoustics, Sound level meters, Part 1: Specifications.

IEC 61672-2 (2003-04) - Electroacoustics, Sound level meters, Part 2: Pattern evaluation tests.

IEC 61260 (1995-08) - Electroacoustics, Octave-band and fractional-octave- band filters.

ANSI S1.11-2004 - American National Standard "Specification for Octave- Band and Fractional-Octave- Band Analog and Digital Filters."

ANSI S1.4-1983 (R2001) - American National Standard "Specification for Sound Level Meters."

ANSI S1.43-1997 (R2002) - American National Standard "Specifications for Integrating Averaging Sound Level Meters."

Earlier standards - IEC 60651 and IEC 60804.

EMC emissions and immunity

Pending testing on production products.

References

Air temperature:	23°C
Static pressure:	101,325 kPa
Relative humidity:.....	50%
Level:	114 dB
Frequency:.....	1 kHz
Microphone Capacitance:	18 pf
Microphone Sensitivity:	-28 dB
Range:	140 dB
Angle:.....	0°

Mechanical characteristics

Housing: Stainless fiber-filled ABS/polycarbonate with internal EMC shielding.

Size: 7.9 cm(W) x 28.2 cm (H) x 4.1 cm (thick); (with preamp and microphone)
3.1"(W) x 11.1"(H) x 1.6" (thick) (with preamp and microphone)

- The width is measured across the face of the instrument. The length, which includes the preamplifier but not the microphone, is measured along the longest axis of the instrument.

Weight: 0.54 kg (1.2 lbs), including batteries.

Tripod mount: Threaded insert on the back of the instrument. Accepts a 1/4"-20 screw.

Electrical characteristics

While the instrument is operating from battery or external power it conforms to all applicable tolerance limits of the stated standards. While operating on battery power alone the instrument will automatically shut down when the battery power is depleted. The total battery voltage range is between the maximum overcharge voltage of the NiMH cells 6.6 volts and the low voltage automatic shut down voltage of 4.4 volts.

Power sources

Internal Power	Approximately 8 hours of continuous operation at normal mode of operation under reference environmental conditions when full capacity batteries are installed.
	Main batteries - Four, replaceable alkaline AA batteries included as original equipment. Rechargeable NiMH batteries available as an option.
	Battery life (Constant run without backlighting) - Varies greatly depending on whether alkaline or NiMH batteries are in use and the logging configuration. You can expect the longest battery life when using rechargeable 2700 mAh (or greater) cells. Battery life is slightly shorter in units that contain either filter option.
	Battery life (Constant run with backlighting) - Will reduce battery life by approximately 10%.
	Auxiliary battery - Internal battery protects against loss of settings when the main batteries are being replaced.

External Power	External DC power may be provided to the Power jack from the AC or DC sources identified below. Power consumption will range from 1.0-1.5 W at 8-16 VDC. <ul style="list-style-type: none"> • 8 VDC - 125 to 190 mA. • 12 VDC - 85 to 125 mA. • 16 VDC - 60 to 90 mA.
	AC power source ~ Optional switching-type power supply, TSI part number 053-571. <ul style="list-style-type: none"> • Supply input - 100-240V, 47-63 Hz. • Supply output - 9VDC, 1.1A max. • DC connector - Cable has 2.1mm plug (center pin positive) • AC adapters - Included are different snap-on adapters that allow it to plug into various outlets.
	DC power source - TSI offers a cable as an option that plugs into an automobile auxiliary jack, TSI part number 053-870. 9.0 Volts is the nominal power supply voltage to be applied to the DC power jack.

Preamplifier (removable)

Microphone.....Accepts 13.2 mm (0.52") microphone directly. Other sizes require an adapter.

Input impedanceGreater than 1 G Ω ; less than 2 pF.

Signal limit.....11 VAC maximum.

Cable attachment.....Capable of driving up to a 15M cable with negligible signal loss.

Meters

Dual metersContains two separate meter circuits, each of which can be individually configured with variable parameters.

Input impedance20 k Ω in series with 11 μ F capacitance, with 100 pF capacitance to ground.

Bandwidth

The following bandwidth is typical for the instrument and preamp when set to the 40-140 dB range and F-weighting. Electrical signals are input to the system with the 059-703 input adapter installed on the preamp.

- **0.1 dB down** - 20 Hz to 14 kHz
- **1.0 dB down** - 5 Hz to 25.2 kHz
- **3.0 dB down** - 3 Hz to 25.8 kHz

Octave filters (optional)

Number of bands Eleven bands, with center frequencies (f_c) ranging from 16 Hz to 16 kHz. The octave filters are flat within < 0.3 dB in each passband. The half-power points are at $0.707 f_c$ and $1.414 f_c$.

Octave skirts With respect to f_c :

- **$f_c/2$ frequencies** - Approximately 20 dB down
- **$2f_c$ frequencies** - Approximately 30 dB down
- **$f_c/10$ frequencies** - Approximately 70 dB down
- **$10f_c$ frequencies** - Approximately 95 dB down

Third-octave filters (optional)

Number of bands Thirty-three bands, with center frequencies from 12.5 Hz to 20 kHz. The $1/3$ octave filters are flat within < 0.3 dB in each passband. The half-power points are at $0.89 f_c$ and $1.12 f_c$.

Third-octave skirts With respect to f_c , the $f_c/2$ and $2f_c$ frequencies are both approximately 50 dB down.

Instrument noise

Noise floor depends upon which microphone is being used. The following measurements are for a typical instrument, with the 059-703 adapter (18 pF) connected to the preamp and shorted at the BNC end. This condition closely simulates the noise floor of a $1/2$ -inch microphone. For these measurements, the instrument was set to the lowest range and to a slow response time.

- 22 dBA
- 30 dBC
- 35 dBZ
- 40 dBF

Environmental effects

The typical time interval needed to stabilize after changes in environmental conditions is 5 minutes for each 10°C change.

Temperature

Operating Less than ± 0.5 dB effect over -10°C to 50°C (14°F to 122°F).

Storage 25°C to 70°C (-13°F to 158°F).

Humidity

10% to 90% RH (non condensing).

User interface

Display

Size 128 x 64 pixel display that measures 6 cm x 4.8 cm (2.4" x 1.9").

Lighting Transflective to take advantage of ambient lighting plus fiberoptic backlighting that can be manually operated or set to turn off after a timed interval.

Keypad

Construction Molded layer that holds fourteen press-sensitive buttons.

Buttons Five buttons have dedicated control functions, another five are primarily used for selection and navigation, and another four provide variable functions when they are defined in the display (soft keys).

Languages

English, Spanish, German, French, Italian and Portuguese.

Input/output

Memory card Removable Secure Digital (SD) data storage device that is inserted in a slot at the base of the instrument. Stores measurements made in studies and sessions in session files. If the instrument has a logging option installed and is logging measurements, the logged values are stored in the applicable session file as well. The card also stores configuration files.

Microphones

The following specifications apply to microphones connected to the instrument.

QE7052	Free-field, Class/Type 2, (standard), low cost ½-inch diameter (.52"), electret (200 volts must be set to "Off")
BK4936	Free-field, Class/Type 1, (standard) ½-inch diameter (.52"), electret (200 volts must be set to "Off")
QE4110	Free-field, Class/Type 1 (optional) ¼-inch diameter (.276"), condenser (200 Volts must be set to "On"). Use for very high dB level free-field measurements. Requires a special preamp to handle high levels. Please contact TSI.
QE4130	Free field, Class/Type 1 (optional), ½-inch diameter (.52"), condenser (200 volts must be set to "On"). Use for general, higher-level, free- field measurements.
QE4150	Free-field, Class/Type 1 (optional) ½-inch diameter (.52"), condenser (200 volts must be set to "On"). Use for general free-field measurements.
QE4170	Pressure, Class/Type 1 (optional), 1-inch diameter (.938"), condenser (200 volts must be set to "On"). Use for coupler measurements, audiometer calibration, low-frequency measurements, low level measurements (due to low noise floor) or as a laboratory standard.

Characteristic	BK4936	QE7052	QE4110	QE4130	QE4150	QE4170
Accuracy	Class 1	Class 2	Class 1	Class 1	Class 1	Class 1
Polarization	Electret	Electret	200V	200V	200V	200V
Diameter (inches)	½	½	¼	½	½	1
Response characteristic	Free- Field	Free- Field	Free- Field	Free- Field	Free- Field	Pressure
Frequency response (±2 dB)	8 Hz to 20 kHz	20 Hz to 17 kHz	20 Hz to 24.5 kHz	5 Hz to 24.5 kHz	5 Hz to 20 kHz	3 Hz to 10 kHz
Sensitivity (dBV)	-28	-29	-49.1	-36	-26	-26
Sensitivity (mV)	40	35	3.5	15.8	50	50
dB noise (1 kHz third- octave band)	0	0	-	10	0	-1
dBA noise	22	22	-	32	22	18
dBC noise	31	31	-	41	31	21
dBZ noise	35	35	-	45	35	25
dB noise	40	40	-	50	40	33
Mic range dBA min. (recommended)	27	27	60	37	27	23
dB Peak	142	143	167	150	143	140
Nominal capacitance (pF)	12	15	6.5	18	18	60
Part number	059-523	056-317	059-413	058-659	058-489	058-488

AC/DC outputs

- Connector** One 3.5 mm stereo plug connector for both AC and DC outputs.
- AC output** Meter 1 output, and includes the frequency response setting for that meter. The AC output is affected by the instrument's range setting.
- DC output** Meter 1 output, and includes the effects of the time response and frequency weighing for the meter.

Communications ports

- Auxiliary** For trigger signals and RS-232 communication.
- USB** Mini USB connector. This port is used for data and file transfers between the instrument and a personal computer.

Measurements

Types

- SPL measures** SPL, Average value (L_{avg} or L_{eq}), Maximum value (L_{Mx}), Minimum value (L_{Mn}), Peak value (L_{Pk}).
- Noise dosimetry** Sound Exposure Level (SEL), Time Weighted Average (TWA), Projected TWA (PTWA), Taktmaximal (TAKTMX), Dose, Projected Dose (PDSE), Exposure (EXP).
- Community noise**
- Dosimetry** Exceedance (L_n), Day-Night average (L_{dn}), Community Noise Exposure Level (CNEL), SPL difference for "C" and "A" time response settings (L_{c-a}).
- Overload Time (OL)** The percentage of time over the OL setting.

Ranges

- Broadband** Eight selectable ranges of 90 dB each.
- Filtered** Eight selectable ranges of 80 dB each.

Measurement parameters

- Response time** Fast, slow and impulse.
- Frequency weighting** .. A, C, Z and F (flat).
- Threshold** 10 to 140 dB or OFF.
- Exchange Rate (ER)** 3, 4, 5 and 6 dB.
- Criterion Level (CL)** 40 to 100 dB.
- Upper Limit (UL)** 10 to 140 dB.
- Projected Time** 1 to 24 hours.

Other

Maximum peak level ...3 dB over the full-scale reading.

Calibration

Pre-calibration When performed, valid prior to the start of a session.

Post-calibration When performed, valid for the previous study in the session.

Storage All calibrations for a session are stored in the related session file.

Calibrators All TSI Calibrators have an output of 114dB at 1 kHz, and some may have other settings. See “Preparing to calibrate” in Chapter 6) or additional information about calibrators.

Studies and sessions

Run-time clock Duration of every run and session shown in screens as well as added to the session file.

Manual operation Run, Pause and Stop keys.

Programmed operation Three Auto-Run modes:

- Date (four options).
- Day of the week (any time on any day).
- Timed (future start time).

Triggered runs Trigger on measured SPL or on external input. Triggers can start a study, then either pause in the session or stop the session.

Triggered outputs Output logic signals related to run status.

Special features

Security

Runs Prevents the pausing of a study without first providing a 4-digit code.

Setups Prevents the changing of settings without first providing a 4-digit code.

Codes Run and setup security can use different codes.

Back-erase

Erasing Up to 20 seconds of sampled SPL data can be removed from the end of the last study. When removed, all calculations based on the removed segment of data are immediately updated.

Editing The length of the back-erased segment can be edited.

Storage Data removed by back-erasing is retained in the session file.

Logging (optional)

Measurements User-selectable for each of the two meters. Includes two measurements of exceedance for Meter 1 (only for logging intervals equal or greater than one minute).

With filtering If a filtering option is installed, either broadband or filtered logging can be selected, where filtered logging will depend upon the analysis type setting for the session.

Logging interval User-selectable from among 11 settings ranging from 1 second to one hour.

Part numbers

Replacement parts

Part Number	Description
053-840	SoundPro SE/DL Class 1 BK4936 microphone kit (BK4936 microphone, 056-990 microphone-to-calibrator adapter and 059-344 windscreen).
053-841	SoundPro SE/DL Class 2 QE7052 microphone kit (QE7052 microphone, 056-990 microphone-to-calibrator adapter and 059-344 windscreen).
053-700	SoundPro SE/DL standard preamp.
017-524	SD card.
053-575	SoundPro SE/DL USB cable to pc.
056-164	Wrist strap, 1/4" - 20.
058-115	WS-3 windscreen for 1.0" microphone. Package of 3.
059-344	WS-7 windscreen for 0.5" microphone. Package of 3.
WS-307-5	Windscreen for 0.25" microphone. Package of 5.

Optional parts

Part Number	Description
053-842	SoundPro SE/DL Class/Type 1 QE4170 microphone kit (QE4170 microphone and machined adapter to preamp).
053-843	SoundPro SE/DL Class/Type 1 QE4130 microphone kit (QE4130 microphone, 056-990 microphone-to-calibrator adapter and 059-344 windscreen).
053-844	SoundPro SE/DL Class/Type 1 QE4110 microphone kit (QE4110 microphone, microphone-to-calibrator adapter and 059-344 windscreen).
059-413	QE4110 free field microphone, 0.25" condenser type.
058-659	QE4130 free field microphone, 0.5" condenser type.

Part Number	Description
058-489	QE4150 free field microphone, 0.5" condenser type.
058-488	QE4170 pressure microphone, 1" condenser type.
053-571	9V Switching-type, universal power supply.
057-860	Detection Management Software
056-981	QC-10 Calibrator; 114dB at 1000 Hz Output.
056-982	QC-20 Calibrator; Selectable 94dB or 114dB at 250 Hz or 1000 Hz Output.
056-990	1/2 inch Microphone-to-calibrator adapter for QC-10 and QC- 20 calibrators.
059-045	TP-1 tripod (height range: 18.5 in. - 48.9 in.).
053-851	SoundPro preamp extension cable, 1 M.
053-852	SoundPro preamp extension cable, 3 M.
053-853	SoundPro preamp extension cable, 15 M.
053-870	SoundPro automobile cable.
058-700	AC/DC cable.
053-729	Serial Connector Cable
016-127	AC/DC output cable
053-372	Direct coupled input adapter
059-703	BNC preamp Input adapter with 18 pF capacitor.
053-711	SoundPro SE/DL carrying case.

Port pinouts

AC/DC jack

The pinout for the jack used for the AC/DC signals is displayed below in Figure A-1. This 3.5-millimeter jack is the same type of jack commonly used for stereo outputs in music systems.

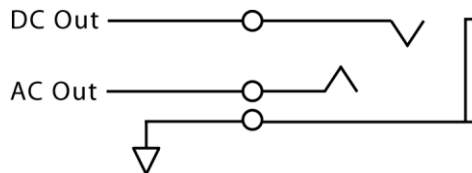

Figure A-1: Pinout for the AC/DC output jack

Auxiliary connector

The auxiliary connector in the base of the instrument can be used for input and output triggers (See “Triggers”) to receive GPS signals or for RS-232 serial communications. Figure A-2 shows the pinout for the auxiliary connector.

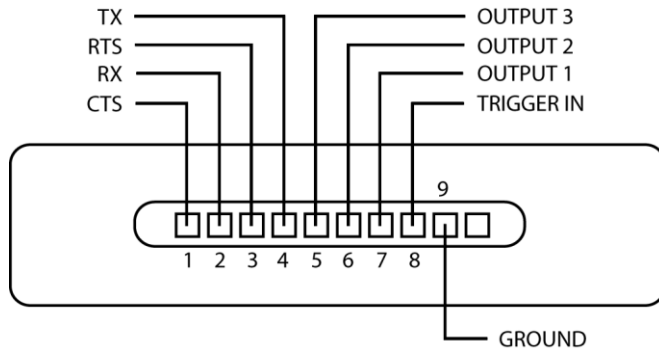
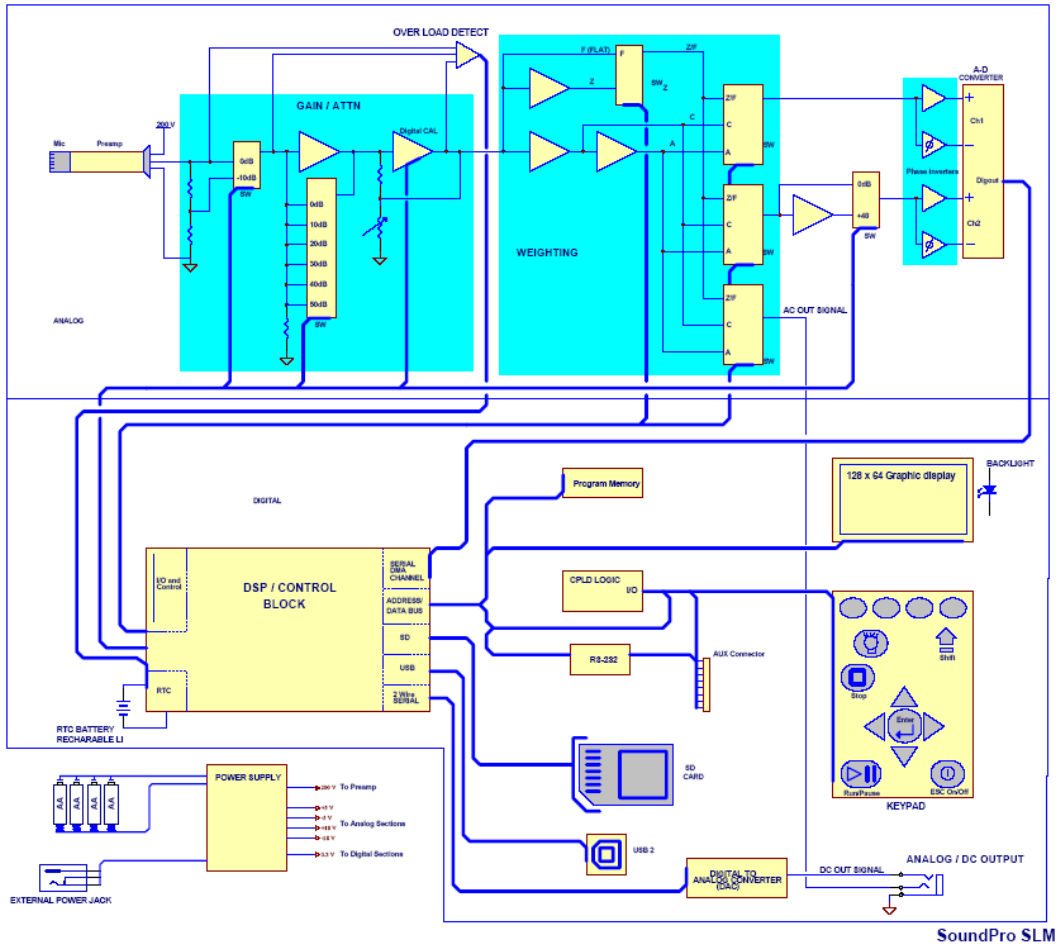

Figure A-2: Auxiliary connector

Block Diagram for SoundPro Sound Level Meter



Glossary of Terms

C-A

The C-A measurement is an SPL average that enhances the low-frequency components of the sound signal.

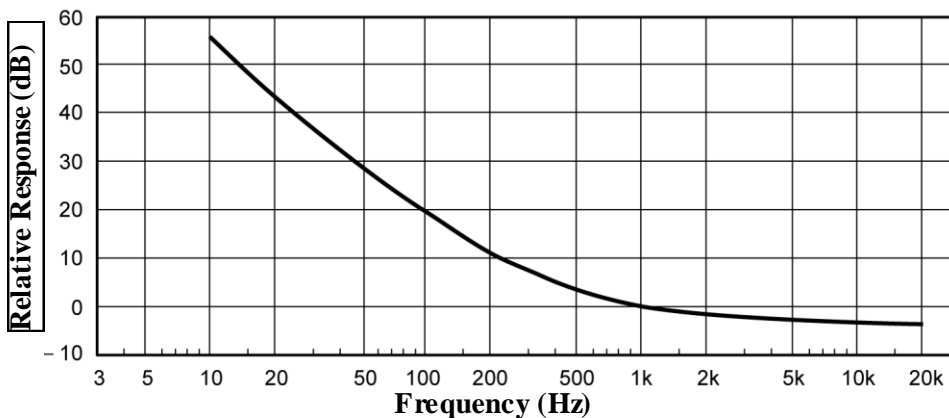

Figure B-1: C-A weighting response curve

Center frequency

The center frequency of each octave and third octave filter band.

CNEL

Community Noise Exposure Level. The accumulated exposure to sound measured in a 24-hour sampling interval and artificially boosted during certain hours. For CNEL, samples taken between 7 p.m. and 10 p.m. are boosted by 5 dB; samples taken between 10 p.m. and 7 a.m. are boosted by 10 dB. The values reported by SoundPro SE/DL ignore the threshold and use a 3 dB Exchange Rate, regardless how those parameters are set.

Criterion Level

Criterion Level. The average SPL that would result in 100% dose over the Criterion Time (usually 8 hours).

CT

Criterion Time. At the Criterion Level, the time period over which the resulting dose is 100%. Usually is 8 hours.

dB

Sound Level Meters use the decibel as the unit of measure known as Sound Pressure Level (SPL). SPL uses the ratio between a reference level of 20 microPascals (.00002 Pascals) and the level being measured.

$$\text{SPL} = 20 \log (\text{measured level}/\text{reference level})$$

Example: the SPL for 1 Pascal is $20 \log (1 \text{ Pascal}/.00002 \text{ Pascal}) = 94 \text{ dB}$ 20 microPascals (.00002 Pascals) is considered the average threshold of hearing.

A whisper is about 20 dB. A normal conversation is typically from 60 to 70 dB, and a noisy factory from 90 to 100 dB. Loud thunder is approximately 110 dB, and 120 dB borders on the threshold of pain.

Dose

Related to the Criterion Level, a dose reading of 100% is the maximum allowable exposure to accumulated noise. For OSHA, 100% dose occurs for an average sound level of 90 dB over an 8-hour period (or any equivalent exposure). By using a TWA reading rather than the average sound level, the time period is no longer explicitly needed. A TWA of 90 dB is the equivalent of 100% dose. The dose will double (halve) every time the TWA increases (decreases) by the Exchange Rate.

- ☑ **Example:** OSHA uses an Exchange Rate of 5 dB. Suppose the TWA is 100 dB. The dose would double for each 5 dB increase over the Criterion Level of 90 dB. The resulting dose is therefore 400%. If the TWA was instead equal to 80 dB then the dose would halve for each 5 dB below the Criterion Level. The resulting dose would be 25%.
- ☑ When taking noise samples less than the full workday, dose is an easy number to work with because it is linear with respect to time.
- ☑ **Example:** If a 0.5-hour sample results in 9% dose and the workday is 7.5 hours long, then the dose for the full workday would be a 135% dose ($7.5 / 0.5 \times 9\%$). This is computed making the assumption that the sampled noise will continue at the same levels for the full 7.5-hour workday.

Dynamic range

The range of input amplitudes on any given range setting over which the instrument can produce a meaningful response. The bottom of the dynamic range is the instrument's Noise Floor for that range setting, and the top of the dynamic range is the maximum input signal that will not overload the instrument on that range setting.

Exceedance Level (Ln)

Exceedance levels represent the percent of the run time that was spent at or above the corresponding dB level.

- ☑ **Example:** An L40 equal to 73 dB would mean that for 40% of the run time, the decibel level was equal to or higher than 73 dB.
- ☑ Exceedance levels can be set from 1% to 99%.

Exchange Rate (ER)

Also known as the Doubling Rate, this refers to how the sound energy is averaged over time. Using the decibel scale, every time the sound energy doubles, the measured level increases by 3 dB. This is the 3 dB Exchange Rate that most of the world uses. For every increase of 3 dB in the time-weighted average, the measured dose would double.

Some organizations such as OSHA in the U.S. have argued that the human ear self-compensates for changing noise levels and they felt that the 3 dB Exchange Rate should be changed to more closely match the response of the human ear. OSHA currently uses a 5 dB Exchange Rate, which would mean that the reported dose would double with every 5 dB increase in the time-weighted average. The Exchange Rate affects the integrated reading L_{AVG} , Dose, and TWA but does not affect the instantaneous sound level.

ExpHrs

Hours of sound exposure. Accumulated exposure to sound measured in hours using an Exchange Rate of 3 dB. The display will switch to ExpSec if RTIME is less than one hour.

$$EXP_{Hrs} = [2^{(L_{eq} - 94)/3.01}] \frac{RTIME}{3600} Pa^2H$$

OR

$$EXP_{Hrs} = \frac{(P_o^2 T) [10^{0.1 \times L_{Aeq}}]}{3600} Pa^2H$$

where $P_o = 20 \mu Pa$

ExpSec

Seconds of sound exposure. Accumulated exposure to sound measured in seconds using an Exchange Rate of 3 dB. The display will switch to ExpHrs if RTIME is greater than 3600 seconds.

$$EXP_{Sec} = [2^{(L_{eq} - 94)/3.01}] RTIME Pa^2S$$

OR

$$EXP_{Sec} = (P_o^2 T) [10^{0.1 \times L_{Aeq}}] Pa^2S$$

where $P_o = 20 \mu Pa$

Level (L_{FT})

Notation used to represent sound pressure level measurements in IEC/ISO notation, where the measurements are made with particular frequency (F) and time (T) response parameters. For an actual measurement, the F and T parameters are replaced by standardized notation for those parameters.

L_{AV}

Average sound level measured over the run time. This becomes a bit confusing when thresholds are used. Any sound below the threshold is not included in this average. Remember that sound is measured in the logarithmic scale of decibels therefore the average cannot be computed by simply adding the levels and dividing by the number of samples. When averaging decibels, short durations of high levels can significantly contribute to the average level.

Example: Assume the threshold is set to 80 dB and the Exchange Rate is 5 dB (the settings of OSHA's Hearing Conservation Amendment). Consider taking a one-hour noise measurement in an office where the A-weighted sound level was typically between 50 dB and 70 dB. If the sound level never exceeded the 80 dB threshold during the one-hour period, then the L_{AVG} would not indicate a reading of zero. If 80 dB was exceeded for only a few seconds due to a telephone ringing near the instrument, then only those seconds will contribute to the L_{AVG} resulting in a level perhaps around 40 dB (notably lower than the actual levels in the environment).

$$L_{avg} = ER \left[\log_2 \int_0^{RTIME} 2^{LS/ER} dt - \log_2 (RTIME) \right] dB$$

L_{EQ}

The true equivalent sound level measured over the run time. The term L_{EQ} is functionally the same as L_{AV} except that it is only used when the Exchange Rate is set to 3 dB and the threshold is set to none.

LDN

Representing the Day/Night sound level, this measurement is a 24-hour average sound level where 10 dB is added to all of the readings that occur between 10 pm and 7 am. This is primarily used in community noise regulations where there is a 10 dB "penalty" for night-time noise. Typically, LDN's are measured using A weighting, a 3 dB Exchange Rate, and no Threshold.

L_{Mn}

Minimum SPL. Lowest SPL measured over a time interval.

L_{Mx}

Maximum SPL. Highest SPL measured over a time interval.

Logging

In sound studies, the saving of measurements at fixed intervals during a study, where each measurement is determined from data processed in the previous logging interval.

L_{pk}

Peak SPL. This is the highest SPL value obtained during a study or a session. A peak SPL measurement is affected by the frequency response setting but not by the time response setting of the meter.

Octave band

An Octave band is defined as a frequency band whose upper band-edge frequency is twice the lower band frequency.

Noise

Unwanted sound.

NCB (Balanced Noise Criterion Curves)

This is the most recent incarnation of the curves based on Beranek's work (1987). This curve family goes beyond a simple tangency method to try to ensure a more neutral characteristic to the noise spectrum and also accounts for speech interference such as: rumble, rattle, and hiss. NCB was recommended for use with HVAC systems and similar applications and accounts for lower frequency sounds in comparison to NC curves.

When setting NCB as the type on the meter, you should use S12.1 unless a local ordinance or similar requirement specifies the use of a tangency technique. (This is usually specified in a standard.)

Noise Criterion Curves (NC)

With NC curve evaluation, sound is measured in octave bands in 8 octave bands ranging from 63 to 8000 Hz and is then plotted on the octave band spectrum using a set of curves.

NC curve evaluation uses a tangency method. A tangency method is a process of comparing your measurements to a fixed curve. The correct curve number is the lowest curve that meets or exceeds the measured octave values. Typically, this is used in HVAC applications.

Noise Rating Curves (NR)

This curve family is a tangency technique and is used primarily in Europe and Australia. It is used not only for HVAC and machine noise applications, but also in community noise enforcement.

Noise Floor

The signal magnitude at the bottom of the instrument's linear range. Input signals below the noise floor cannot be differentiated from the internal noise of the instrument.

Overload (OL)

An overload will occur whenever the input signal exceeds the dynamic range of the instrument.

Pascal (Pa)

Unit of pressure equal to 1 Newton per square meter.

PTWA

This is a projected TWA determined for a projected time (Prt) in relation to the Criterion Time (CT) as follows.

$$TWA = L_{avg} + ER \left[\log_2 \left(\frac{Prt}{CT} \right) \right] dB$$

Peak –C

The following chart illustrates the range of Sound Level with C-weighted Peak.

Level Range (dB)	Peak C Level Range (dB)	Level Range (dB)	Peak C Level Range (dB)
-20 to 70	42.2 to 73	20 to 110	42.7 to 113
-10 to 80	42.6 to 83	30 to 120	46.7 to 123
0 to 90	41.6 to 93	40 to 130	55.4 to 132
10 to 100	43.4 to 103	50 to 140	66.3 to 142

Preferred Noise Criterion (PNC) Curves

The Preferred Noise Criterion Curves, a type of tangency method, was an update to Beranek's original NC curves that accounted for the lower frequency side of the criterion curves (1971). The PNC curves extended the range to 32 Hz instead of 63 Hz used in NC curves.

Projected time (Prt)

A time interval used in some calculations, usually different from the actual run time of a study or session.

Reference pressure

The sound pressure at the threshold of human hearing, as measured under standard conditions. This generally accepted magnitude of this pressure is 2×10^{-5} Pascals (Pa).

Response time (F, S, I)

Selectable time response settings used in SoundPro SE/DL measurements. The response time is a standardized exponential time weighting of the input signal according to fast (F), slow (S) or impulse (I) time response relationships. Time response can be described with a time constant. The time constants for fast, slow and impulse responses are 0.125 s, 1.0 s and 35 ms, respectively. Impulse time response is 35ms rise with a constant decay of 2.9dB/sec.

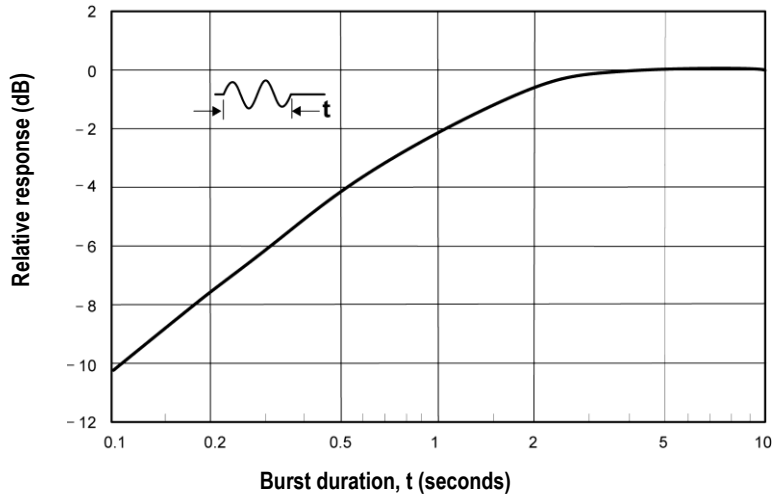

Figure B-2: Slow response to a tone burst

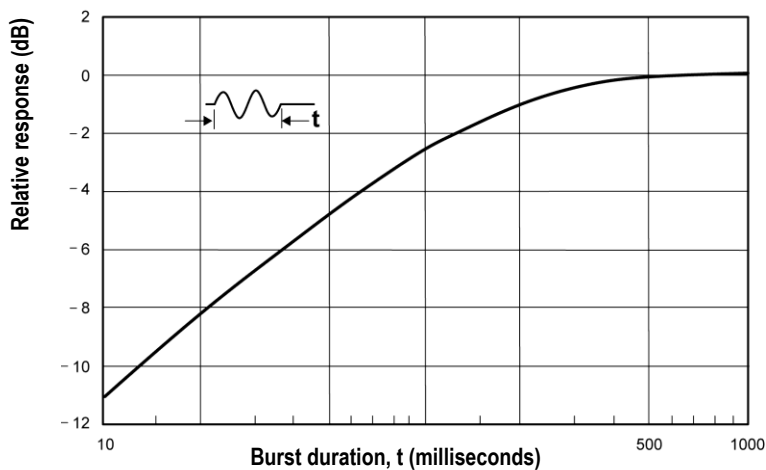

Figure B-3: Fast response to a tone burst

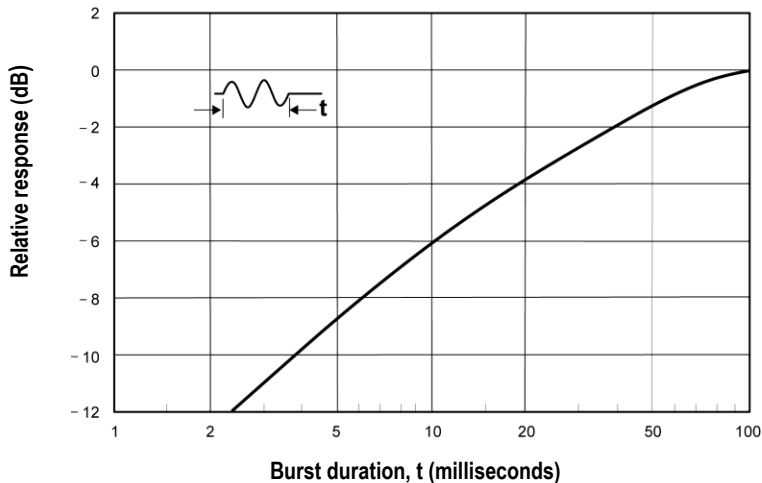

Figure B-4: Impulse response to a tone burst

Room Criterion Curves (RC)

Room Criterion curve's was introduced in 1981 by Blazier to primarily rate noise in offices/room acoustics. This methodology calculates a numerical rating based on speech interference and indicates any interference such as hissing, rumbling, or vibration.

SEL

Sound Exposure Level. The continuous SPL lasting one-second that would deliver the same sound exposure as an accumulated exposure determined over a sampling interval (RTIME). SEL is typically determined with a 3 dB Exchange Rate, slow exponential time-weighting, and without regard to an Integrating Threshold.

$$SEL = ER \left[\log_2 \int_0^{RTIME} 2^{L/ER} dt \right] dB$$

SPL

Sound pressure level. A ratio of one sound pressure to a reference pressure (See Reference Pressure). Because of the enormous dynamic range of the human ear, the ratio is calculated logarithmically by the formula below, where L_r is the reference pressure.

$$SPL = 20 \log \left(\frac{L}{L_r} \right) dB$$

Taktmx

A time average over a sampling interval that uses the highest level occurring during the preceding Taktmaximal Interval, either three or five seconds, and assumes that it was present for the whole Taktmaximal Interval.

Third-octave band

A Third-octave band is defined as a frequency band whose upper band- edge frequency is 1.26 times the lower band frequency.

Threshold

An SPL value that defines a lower level of acceptable values. Only SPL samples that exceed the threshold are used in some calculations.

TWA

Time weighted average. The constant SPL over an 8-hour interval that would produce the same exposure to sound as an exposure measured over a run time sampling interval (Rtime).

$$TWA = ER \left[\log_2 \int_0^{RTIME} 2^{L/ER} dt - \log_2 (CT) \right] dB$$

Upper Limit (UL)

The total time during a study that the SPL exceeds the Upper Limit meter setting.

Weighting (A, C, Z, F)

SPL measurements are commonly weighted (scaled) in relation to their frequency components in order to provide a consistent basis for comparison to other measurements of the same type. In addition to the standardized A, C and Z weighting curves, you can select F-weighting (flat) which provides no weighting at all. The four SoundPro SE/DL weighting curves are plotted together in Figure B-5, where the F-weighting curve has been shifted up by 5 dB for graphical clarity. The tolerance limits for F frequency weighting are the same as A, C, and Z frequency weighting.

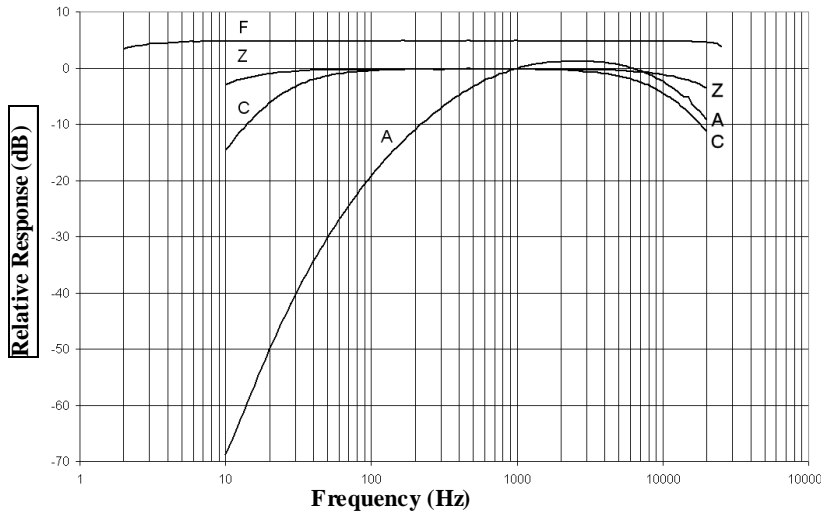

Figure B-5: All frequency weightings plotted together

Windscreen

A covering for a microphone that reduces disturbances caused by wind and direct contact with other surfaces.

Customer service

This section gives directions for contacting TSI Incorporated for technical information and directions for returning the SoundPro Sound Level Meter for service.

Technical Support Contacts

If you have any difficulty setting or operating the instrument, or if you have technical or application questions about this system, contact TSI's Technical Support.

North America and Asia Pacific	Europe, Middle East, and Africa
Telephone: 1-800-680-1220 (USA); +1 651-490-2860 (Outside USA)	Telephone: +49 241-52303-0
Fax: +1 651-490-3824	Fax: +49 241 52303-49
E-mail: technical.services@tsi.com	E-mail: tsigmbh@tsi.com

Service Contact Information

If your instrument does not operate properly, or if you are returning the instrument for service, visit our website at <http://rma.tsi.com> for a Return Material Authorization, or contact Customer Service.

North America and Asia Pacific	Europe, Middle East, and Africa
TSI Incorporated 1060 Corporate Center Drive Oconomowoc, WI 53006-4828	TSI Instruments Ltd. Stirling Road Cressex Business Park High Wycombe, Bucks HP12 3ST United Kingdom
Telephone: 1-800-680-1220 (USA); +1 651-490-2860 (Outside USA)	Telephone: +44 (0) 149 4 459200
E-mail: technical.services@tsi.com	E-mail: tsiuk@tsi.com

Returning for Service

Visit our website at <http://rma.tsi.com> and complete the on-line “Return Merchandise Authorization” form or call TSI at 1-800-680-1220 (USA) or (651) 490-2860, or 001 651 490 2860 (International) for specific return instructions.

Customer Service will need the following information:

- The instrument model number
- The instrument serial number
- A purchase order number (unless under warranty)
- A billing address
- A shipping address

Use the original packing material to return the instrument to TSI. If you no longer have the original packing material, seal off any ports to prevent debris from entering the instrument and ensure that the display and the connectors on the instrument front and back panels are protected. This instrument is very fragile and must be packed in a manner appropriate for a precision instrument.

Calibration

The SoundPro meter and TSI field calibrator devices should be examined regularly by the factory. An annual calibration is recommended. (Please see Service Department above.)

Warranty

(For country-specific terms and conditions outside of the USA, please visit www.tsi.com.)

Seller warrants the goods, excluding software, sold hereunder, under normal use and service as described in the operator's manual, to be free from defects in workmanship and material for **12 months**, or if less, the length of time specified in the operator's manual, from the date of shipment to the customer. This warranty period is inclusive of any statutory warranty. This limited warranty is subject to the following exclusions and exceptions:

- a. Hot-wire or hot-film sensors used with research anemometers, and certain other components when indicated in specifications, are warranted for 90 days from the date of shipment;
- b. Pumps are warranted for hours of operation as set forth in product or operator's manuals;
- c. Parts repaired or replaced as a result of repair services are warranted to be free from defects in workmanship and material, under normal use, for 90 days from the date of shipment;
- d. Seller does not provide any warranty on finished goods manufactured by others or on any fuses, batteries or other consumable materials. Only the original manufacturer's warranty applies;
- e. This warranty does not cover calibration requirements, and seller warrants only that the instrument or product is properly calibrated at the time of its manufacture. Instruments returned for calibration are not covered by this warranty;
- f. This warranty is **VOID** if the instrument is opened by anyone other than a factory authorized service center with the one exception where requirements set forth in the manual allow an operator to replace consumables or perform recommended cleaning;
- g. This warranty is **VOID** if the product has been misused, neglected, subjected to accidental or intentional damage, or is not properly installed, maintained, or cleaned according to the requirements of the manual. Unless specifically authorized in a separate writing by Seller, Seller makes no warranty with respect to, and shall have no liability in connection with, goods which are incorporated into other products or equipment, or which are modified by any person other than Seller.

The foregoing is **IN LIEU OF** all other warranties and is subject to the LIMITATIONS stated herein. **NO OTHER EXPRESS OR IMPLIED WARRANTY OF FITNESS FOR PARTICULAR PURPOSE OR MERCHANTABILITY IS MADE. WITH RESPECT TO SELLER'S BREACH OF THE IMPLIED WARRANTY AGAINST INFRINGEMENT, SAID WARRANTY IS LIMITED TO CLAIMS OF DIRECT INFRINGEMENT AND EXCLUDES CLAIMS OF CONTRIBUTORY OR INDUCED INFRINGEMENTS. BUYER'S EXCLUSIVE REMEDY SHALL BE THE RETURN OF THE PURCHASE PRICE DISCOUNTED FOR REASONABLE WEAR AND TEAR OR AT SELLER'S OPTION REPLACEMENT OF THE GOODS WITH NON-INFRINGEMENTS GOODS.**

TO THE EXTENT PERMITTED BY LAW, THE EXCLUSIVE REMEDY OF THE USER OR BUYER, AND THE LIMIT OF SELLER'S LIABILITY FOR ANY AND ALL LOSSES, INJURIES, OR DAMAGES CONCERNING THE GOODS (INCLUDING CLAIMS BASED ON CONTRACT, NEGLIGENCE, TORT, STRICT LIABILITY OR OTHERWISE) SHALL BE THE RETURN OF GOODS TO SELLER AND THE REFUND OF THE PURCHASE PRICE, OR, AT THE OPTION OF SELLER, THE REPAIR OR REPLACEMENT OF THE GOODS. IN THE CASE OF SOFTWARE, SELLER WILL REPAIR OR REPLACE DEFECTIVE SOFTWARE OR IF UNABLE TO DO SO, WILL REFUND THE PURCHASE PRICE OF THE SOFTWARE. IN NO EVENT SHALL SELLER BE LIABLE FOR LOST PROFITS, BUSINESS INTERRUPTION, OR ANY SPECIAL, INDIRECT, CONSEQUENTIAL OR INCIDENTAL DAMAGES. SELLER SHALL NOT BE RESPONSIBLE FOR INSTALLATION, DISMANTLING OR REINSTALLATION COSTS OR CHARGES. No Action, regardless of form, may be brought against Seller more than 12 months after a cause of action has accrued. The goods returned under warranty to Seller's factory shall be at Buyer's risk of loss, and will be returned, if at all, at Seller's risk of loss.

Buyer and all users are deemed to have accepted this LIMITATION OF WARRANTY AND LIABILITY, which contains the complete and exclusive limited warranty of Seller. This LIMITATION OF WARRANTY AND LIABILITY may not be amended, modified or its terms waived, except by writing signed by an Officer of Seller.

Service Policy

Knowing that inoperative or defective instruments are as detrimental to TSI as they are to our customers, our service policy is designed to give prompt attention to any problems. If any malfunction is discovered, please contact your nearest sales office or representative, or call TSI's Customer Service department at 1-800-874-2811 (USA) or +001 (651) 490-2811 (International).

(This page intentionally left blank)

Index

AC/DC		Captured Curves	
Output explained	113	Applications	79
Port location	6	Runing and viewing results	87
Alternate functions		Setting up	80
Indicator	18	Center frequency	
Alt	17	Defined	127
Arrows	17	CNEL	
Attaching calibrator to the SoundPro	56	Defined	127
Audiometric background curves		Communications	
Setting-up	85	viewing measurements remotley (log-to-port)	48
Audiometric Background curves		Criterion curves	
Running	87	Running	87
Auto-Run		Setting-up	83
Date setting	33	Types	83
Days of week	36	Criterion Level	
Setting date	35	Defined	127
Auto-Run Shutdown screen	37	CT	
Auxiliary		Defined	127
port location	6	dB	
Average SPL		Defined	128
Defined;	130	DC output	
Back-erasing		Explained	113
explained	65	Display	17
results	65	Dose	
Backlight	17	Defined	128
Setting	31	Dynamic range	
Backlight setting	31	Defined	128
Balanced Noise Criterion Curves		Enter	17
Defined	131	Exceedance Level (Ln)	
Batteries		Defined	128
checking or changing	13	Exchange Rate (ER)	
Indicator	18	Defined	129
installing	12	ExpHrs	
power explained	13	Defined	129
C-A		ExpSec	
Defined	127	Defined	129
C-A measurement	26	File Setups(Config)	
Calibrate		Creating or saving	108
About	55	Files	
History cal screen	58	loading and deleting	105
Post-cal	55	Naming/Renaming	107
Pre-Cal	55	FSetup Files (Config)	
Steps	56	Creating or saving	108
Calibrating	55, 57	GPS	
Captured curves		Explained	49
Running	82	Setting	50

Hardware interface	5	STI-PA testing	89
Indicators		Stop	67
Explained	18	Tabulation screen	64
Information screen		Time History	65
explained	7	Measures setup screen	
Keypad		Gender field	91
example	16	Post Process field	91
explained	17	Memory card	
L_EQ		slot location	6
Defined	130	Memory Card	
L_Mn		About	109
Defined	130	Ejecting	111
L_Mx		Formatting	110
Defined	130	Microphone	
L_Pk		installing	10
Defined	131	installing windscreen	11
LDN		Models	1
Defined	130	Navigating	
Level (L _{FT})		keypad	18
Defined	130	NCB	
level-triggered		Defined	131
Screen explained	39	Noise	
Lock screen	42	Defined	131
Log -to-Port	48	Noise Criterion Curves (NC)	
Logging		Defined	131
Defined	130	Noise Floor	
Setup screen	28	Defined	131
Measurement		Noise Rating Curves (NR)	
Changing Display	59	Defined	131
explained	25	Octave band	
IEC/ISO	51	Defined	131
octave bands	2	on/off/esc	
overview	52	identified	15
range	54	turning off	18
setting measurement type	22	Overload	
third-octave band	3	Indicator	18
Measurements		Overload (OL)	
audiometric background curves	85	Defined	131
Bar chart	62	packing instructions	138
Changing what is displayed	59	Pascal (Pa)	
Community noise	63	Defined	131
criterion curves	82	Past data	
curves explained	78	Viewing	102
Dosimetry screen	63	Past Data	
Filtered bar chart	62	Loading and deleting files	105
Indicators/descriptors	61	Pause	
navigational screens Explained	59	Indicator	18
Pause	67	Peak -C	
Running	58	Defined	132
setting captured curves	80		

Power jack		Screens, Time-History/Back-erase	65
location	6	Screens, viewing	
Power supply		community noise;	63
auto and universal explained	15	Dosimetry screen	63
connecting	15	file	102
Pre-Calibrate history screen	57	filtered bar chart	62
Preferred Noise Criterion (PNC) Curves		Icons	61
Defined	132	Past Measurements	104
Projected time (Prt)		STI-PA	94
Defined	132	tabulation	64
PTWA		Tabulation screen	64
Defined	132	Screens, Viewing	
QuestSuite		Bar chart	62
back-erased data		Screens, viewy;	63
back-erased data;	65	Screens, viewing	
Reference pressure		Bar Chart	58
Defined	132	Secure mode	
Response time		Disabling and backup number	44
fast, slow, impulse	23	Secure run	
Response time (F, S, I)		About	41
Defined	133	Secure run/setup	
returning for service	138	Setting	42
Reverberation		Secure setup	
About	69	About	42
Impulse noise method	71	Secure Setup	44
Interrupted noise method	71	SEL	
Reverb time (RT60)	69	Defined	134
Reverb Time example chart	70	Sessions	
RT60 measurement mode	75	explained	53
RT60 Test	74	introduced;	67
Setup options	73	scenario	53
Setup screen	73	Setup files(Config)	
Review		Deleting	109
Indicator	18	Loading	109
Review mode	102	Setup files(Config.)	
Room Criterion Curves (RC)		Viewing	109
Defined	134	Setup screen	
Run		Auto-run with date of week	36
Indicator	18	Backlight	31
lock	42	Contrast	32
Run Mode security	41	Display	29
Running		Language	30
Quick help list	52	measurement type	22
Saving Setup	108	Meter 1 and meter 2 parameter	23
Screens, general		time and date	21
diagram	16	Setup screens	
start	14	microphone/signal input	20
Screens, setup		Soft key	
battery check	14	Lookup	60

Soft key buttons	17	Study	
Soft key menu	17	scenario	53
Soft keys		Taktnx	
Explained	59	Defined	135
SoundPro SE or DL kit	9	Third-octave band	
Speech Transmission Index		Defined	135
Explained	89	Threshold	
SPL		Defined	135
Defined	134	Timed Run	38
STI-PA		Triggering	
Applying background noise (capture curve)		Setting	45
overview	98	Turning off	18
General setup guidelines	90	TWA	
Modulation envelope screen	96	Defined	135
Modulation screen	95	Underrange	
Running a study	93	Indicator	18
Setup	91	Upper Limit (UL)	
Steps, Applying captured curves	98	Defined	135
Viewing Result screens	94	Weighting	23
Stop	17	Weighting (A, C, Z, F)	
Indicator	18	Defined	136
Stop and pause		Windscreen	
explained	67	Defined	136
Studies			
explained	53		



TSI Incorporated – Visit our website www.tsi.com for more information.

USA Tel: +1 800 874 2811
UK Tel: +44 149 4 459200
France Tel: +33 1 41 19 21 99
Germany Tel: +49 241 523030

India Tel: +91 80 67877200
China Tel: +86 10 8219 7688
Singapore Tel: +65 6595 6388

