

# FUME HOOD CONTROLLER/MONITOR MODEL FHC50/FHM10

---

OPERATION AND SERVICE MANUAL

P/N 6003830, REVISION H  
FEBRUARY 2022



# START SEEING THE BENEFITS OF REGISTERING TODAY!

---

Thank you for your TSI instrument purchase. Occasionally, TSI releases information on software updates, product enhancements and new products. By registering your instrument, TSI will be able to send this important information to you.

**<http://register.tsi.com>**

As part of the registration process, you will be asked for your comments on TSI products and services. TSI's customer feedback program gives customers like you a way to tell us how we are doing.



UNDERSTANDING, ACCELERATED

**TSI Incorporated** - Visit our website **[www.tsi.com](http://www.tsi.com)** for more information.

**USA**      **Tel:** +1 800 874 2811  
**UK**        **Tel:** +44 149 4 459200  
**France**   **Tel:** +33 1 41 19 21 99  
**Germany** **Tel:** +49 241 523030

**India**      **Tel:** +91 80 67877200  
**China**     **Tel:** +86 10 8219 7688  
**Singapore** **Tel:** +65 6595 6388

# FUME HOOD CONTROLLER/MONITOR MODEL FHC50/FHM10

---

OPERATION AND SERVICE MANUAL

P/N 6003830, REVISION H  
FEBRUARY 2022

**U.S. AND CANADA**

Sales & Customer Service:  
(800) 680-1220 / (651) 490-2860  
Fax:  
(651) 490-3824

**SHIP/MAIL TO:**

TSI Incorporated  
ATTN: Customer Service  
500 Cardigan Road  
Shoreview, MN 55126  
USA

**OTHER COUNTRIES**

Sales & Customer Service:  
(001 651) 490-2811  
Fax:  
(001 651) 490-3824

**E-MAIL**

[answers@tsi.com](mailto:answers@tsi.com)

**WEB SITE**

[www.tsi.com](http://www.tsi.com)



**LIMITATION OF WARRANTY AND LIABILITY** (effective February 2015)

(For country-specific terms and conditions outside of the USA, please visit [www.tsi.com](http://www.tsi.com).)

Seller warrants the goods, excluding software, sold hereunder, under normal use and service as described in the operator's manual, to be free from defects in workmanship and material for **24 months**, or if less, the length of time specified in the operator's manual, from the date of shipment to the customer. This warranty period is inclusive of any statutory warranty. **This limited warranty is subject to the following exclusions and exceptions:**

- a. Hot-wire or hot-film sensors used with research anemometers, and certain other components when indicated in specifications, are warranted for 90 days from the date of shipment;
- b. Pumps are warranted for hours of operation as set forth in product or operator's manuals;
- c. Parts repaired or replaced as a result of repair services are warranted to be free from defects in workmanship and material, under normal use, for 90 days from the date of shipment;
- d. This warranty does not cover calibration requirements, and seller warrants only that the instrument or product is properly calibrated at the time of its manufacture. Instruments returned for calibration are not covered by this warranty;
- f. This warranty is **VOID** if the instrument is opened by anyone other than a factory authorized service center with the one exception where requirements set forth in the manual allow an operator to replace consumables or perform recommended cleaning;
- g. This warranty is **VOID** if the product has been misused, neglected, subjected to accidental or intentional damage, or is not properly installed, maintained, or cleaned according to the requirements of the manual. Unless specifically authorized in a separate writing by Seller, Seller makes no warranty with respect to, and shall have no liability in connection with, goods which are incorporated into other products or equipment, or which are modified by any person other than Seller.

The foregoing is **IN LIEU OF** all other warranties and is subject to the **LIMITATIONS** stated herein. **NO OTHER EXPRESS OR IMPLIED WARRANTY OF FITNESS FOR PARTICULAR PURPOSE OR MERCHANTABILITY IS MADE. WITH RESPECT TO SELLER'S BREACH OF THE IMPLIED WARRANTY AGAINST INFRINGEMENT, SAID WARRANTY IS LIMITED TO CLAIMS OF DIRECT INFRINGEMENT AND EXCLUDES CLAIMS OF CONTRIBUTORY OR INDUCED INFRINGEMENTS. BUYER'S EXCLUSIVE REMEDY SHALL BE THE RETURN OF THE PURCHASE PRICE DISCOUNTED FOR REASONABLE WEAR AND TEAR OR AT SELLER'S OPTION REPLACEMENT OF THE GOODS WITH NON-INFRINGEMENTS.**

TO THE EXTENT PERMITTED BY LAW, THE EXCLUSIVE REMEDY OF THE USER OR BUYER, AND THE LIMIT OF SELLER'S LIABILITY FOR ANY AND ALL LOSSES, INJURIES, OR DAMAGES CONCERNING THE GOODS (INCLUDING CLAIMS BASED ON CONTRACT, NEGLIGENCE, TORT, STRICT LIABILITY OR OTHERWISE) SHALL BE THE RETURN OF GOODS TO SELLER AND THE REFUND OF THE PURCHASE PRICE, OR, AT THE OPTION OF SELLER, THE REPAIR OR REPLACEMENT OF THE GOODS. IN THE CASE OF SOFTWARE, SELLER WILL REPAIR OR REPLACE DEFECTIVE SOFTWARE OR IF UNABLE TO DO SO, WILL REFUND THE PURCHASE PRICE OF THE SOFTWARE. **IN NO EVENT SHALL SELLER BE LIABLE FOR LOST PROFITS, BUSINESS INTERRUPTION, OR ANY SPECIAL, INDIRECT, CONSEQUENTIAL OR INCIDENTAL DAMAGES.** SELLER SHALL NOT BE RESPONSIBLE FOR INSTALLATION, DISMANTLING OR REINSTALLATION COSTS OR CHARGES. No Action, regardless of form, may be brought against Seller more than 12 months after a cause of action has accrued. The goods returned under warranty to Seller's factory shall be at Buyer's risk of loss, and will be returned, if at all, at Seller's risk of loss.

Buyer and all users are deemed to have accepted this LIMITATION OF WARRANTY AND LIABILITY, which contains the complete and exclusive limited warranty of Seller. This LIMITATION OF WARRANTY AND LIABILITY may not be amended, modified or its terms waived, except by writing signed by an Officer of Seller.

**SERVICE POLICY**

Knowing that inoperative or defective instruments are as detrimental to TSI as they are to our customers, our service policy is designed to give prompt attention to any problems. If any malfunction is discovered, please contact your nearest sales office or representative, or call TSI's Customer Service department at (800) 680-1220 or (651) 490-2860.

**TRADEMARKS**

TSI, TSI logo, VelociCalc, are registered trademarks of TSI Incorporated in the United States and may be protected under other country's trademark registrations.

BACnet is a trademark of ASHRAE.

Modbus is a registered trademark of Modicon, Inc.

LonWorks is a registered trademark of Echelon® Corporation.

# CONTENTS

<b>HOW TO USE THIS MANUAL .....</b>	<b>1</b>
Safety Information .....	1
Description of Caution Symbol.....	1
Access Code .....	1
<b>PART ONE .....</b>	<b>3</b>
User Basics .....	3
The Instrument .....	3
Face Velocity.....	3
Exhaust Flow.....	3
Useful User Information .....	4
Operator Panel .....	4
LED Lights.....	4
Display Screen .....	5
User Soft Keys (Normal Operating Mode) .....	5
Quick Keys .....	5
Operator Keys .....	6
USB Port .....	6
Alarms.....	6
Visual Alarm .....	7
Audible Alarm—EMERGENCY key .....	7
Audible Alarms—All Except Emergency .....	7
Before Calling TSI® Incorporated .....	7
<b>PART TWO.....</b>	<b>9</b>
Technical Section .....	9
Software Programming.....	10
Programming Keys.....	10
Menu Soft Keys .....	10
Quick Keys .....	11
Keystroke Procedure.....	11
Programming Example.....	12
Hardware Configurations.....	13
Model FHC50 Controller Modes .....	13
Model FHM10 Fume Hood Monitor Modes .....	14
Menu and Menu Items.....	15
CONFIGURE MENU .....	17
SETPOINT/ALARM CONSTRAINTS .....	31
INTERFACE MENU .....	32
NETWORK SETTINGS SUBMENU .....	32
Calibration .....	51
Face Velocity Calibration .....	51
Sash Position Calibration .....	52
Flow Calibration.....	54
Sash Opening Calibration .....	57

Optimizing Controller Performance .....	58
Maintenance and Repair Parts.....	59
System Component Inspection .....	59
Velocity Sensor Cleaning .....	59
Replacement Parts.....	60
Troubleshooting Section.....	60
Hardware Test.....	61
Diagnostics Menu.....	62
Troubleshooting Chart.....	66
<b>APPENDIX A.....</b>	<b>75</b>
Specifications* .....	75
<b>APPENDIX B.....</b>	<b>77</b>
Network Communications .....	77
Modbus® Communications .....	77
Unique to TSI .....	77
Network Points .....	77
N2 Communications Description of Variables.....	81
Description of Variables .....	81
Variable Map .....	82
LonWorks® Object .....	84
Node Object Network Variables.....	84
Fume Hood Controller Object Network Variables.....	84
Description of LON SNVTs .....	86
FHC50 BACnet® MS/TP Protocol Implementation Conformance Statement.....	87
BACnet® MS/TP Object Set.....	89
<b>APPENDIX C.....</b>	<b>93</b>
Wiring Information .....	93
Back Panel Wiring.....	93
<b>APPENDIX D.....</b>	<b>101</b>
Access Codes / Password.....	101



# How to Use This Manual

The Operation and Service Manual describes how to operate, configure, calibrate, maintain and troubleshoot the Model FHM10 Fume Hood Monitor and Model FHC50 Fume Hood Controller. The manual is divided into two parts. [Part one](#) describes the unit and how to interface with the device. This section should be read by users, facilities staff, and anyone who requires a basic understanding of how the device operates.

[Part two](#) describes the technical aspects of the product which include operation, configuration, calibration, maintenance and troubleshooting. Part two should be read by personnel programming or maintaining the unit. **TSI® recommends thoroughly reading this manual before changing any software items.**

NOTE
This operation and service manual assumes that the controller has been properly installed. Refer to the Installation Instructions if there is any question as to whether the controller has been installed properly.

---

## Safety Information

This section gives instructions to promote safe and proper handling of Model FHM10 Fume Hood Monitors and Model FHC50 Fume Hood Controllers.

There are no user-serviceable parts inside the instrument. Opening the instrument case will void the warranty. Refer all service of the unit to a qualified technician.

### Description of Caution Symbol



CAUTION
<p><b>Caution</b> indicates:</p> <ul style="list-style-type: none"><li>• Equipment may be damaged if procedures are not followed.</li><li>• Improper settings may result in loss of containment.</li><li>• Important information about unit operation.</li></ul>

### Access Code

Model FHM10 Fume Hood Monitors and FHC50 Fume Hood Controllers have an access code to limit unauthorized access to the menu system. The access code can be turned on or off through the [ACCESS CODE](#) menu item. When the units ship from TSI®, they are configured with the access code on. Refer to Appendix D, [Access Codes](#), for instructions on entering the access code. Entering the access code enables access to the menu system for a 15-minute period.

*(This page intentionally left blank)*

# Part One

---

## User Basics

This section is designed to provide a brief but thorough overview of the product installed. These few pages explain the purpose (The Instrument) and the operation (Useful user information, Operator panel, Alarms) of the product. Technical product information is available in [Part Two](#) of the manual.

---

## The Instrument

The Model FHM10 Fume Hood Monitor is able to measure and report air flow in fume hoods and other exhaust devices such as snorkels and canopies. The Model FHC50 Fume Hood Controller adds the ability to control airflow to maintain safety and energy efficiency.

There are two main monitor and control strategies that can be used with the Model FHC50 Fume Hood Controller:

### Face Velocity

One of the key components of air flow in a fume hood is adequate face velocity, which is needed to protect fume hood users. An adequate face velocity will help contain contaminants inside of the fume hood.

A fume hood exhaust system produces a negative pressure differential between the fume hood's interior and the laboratory, causing air to be drawn into the hood. The speed of air entering the fume hood is called the face velocity. The Model FHC50 Fume Hood Controller can be configured to continuously monitor fume hood face velocity by measuring the air velocity across a sensor mounted in the sidewall of the hood. The sensor and opening in the fume hood are driven by the same pressure differential so the velocity across each is related.

As an alternative to this sidewall sensing methodology, the Model FHC50 can determine average fume hood face velocity by measuring the fume hood exhaust flow and sash area. When measuring face velocity in this fashion, the Model FHC50 must use a venturi valve with feedback to control and measure the exhaust volume. A sash sensor then measures the vertical opening of the fume hood sash. As an option, the Model FHC50 can use a sidewall sensor to monitor or trim the face velocity when calculated from sash position and exhaust flow rate.

The Model FHC50 controller modulates the exhaust to maintain an adequate face velocity at all times through the fume hood.

### Exhaust Flow

Certain devices such as laminar flow benches, canopy hoods and snorkels need to exhaust a certain amount of air to function properly. For these applications, the Model FHC50 can be configured to measure and control the air flow to a constant volume using a venturi valve or a flow station with damper.

## Useful User Information

The controller has a green light (normal operation) and red alarm light (low and high alarms). The green light is on when the face velocity and/or exhaust flow is adequate. The red alarm light comes on when the face velocity and/or exhaust flow drops below a safe level, or exceeds a safe level. The display provides additional information depending on the configuration of the unit. Some of the available information includes continuously indicating the actual face velocity, exhaust flow, alarms, and controller status.

---

## Operator Panel

The Model FHM10 Fume Hood Monitor and Model FHC50 Fume Hood Controller are easy to use. All the information you need to know about face velocity and flow rates is displayed on the Display Interface Module (DIM). In addition, all configuration, control, and calibration programming is accessible using the soft keys and menus. Specific details about the Model FHC50 controller front panel display and controls are described on the following pages. The front panel, shown in Figure 1 identifies the important features: display, keys and lights.

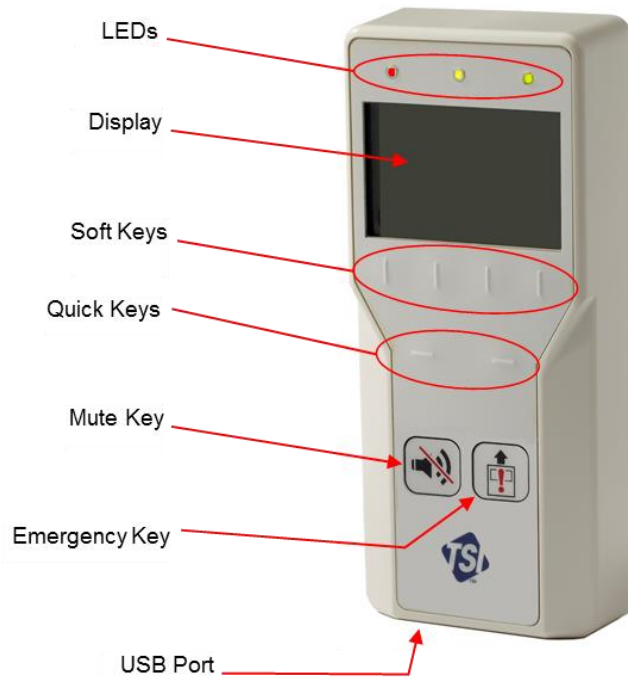

Figure 1

## LED Lights

### Green Light

The green light (NORMAL) is on when the face velocity and/or exhaust flow is adequate. This light indicates the fume hood is operating safely. If a set point cannot be maintained or an alarm limit has been reached, the green light turns off and the red alarm light turns on.

### Yellow Light

The yellow light is on to indicate that the Model FHC50 controller is muted or in setback mode. The LCD display will read "**Setback**" or "**Mute**" at the top of the screen to indicate the meaning of the yellow light. Note that when in Setback mode, the Model FHC50 will also turn on the Red or Green light.

### Red Light

The red light is on to indicate an alarm or emergency status. If the red light flashes, then the Model FHC50 is in emergency mode. If the red light is continually lit, then the Model FHC50 is in an alarm mode. The display screen will also indicate the type of alarm or an emergency message.

## Display Screen

The LCD display is highly configurable and can display various critical information including actual face velocity, exhaust flow rate, alarm status, menu options, and error messages. In addition, the LCD display shows various soft key labels that enable user interaction and programming the unit.

When programming the unit, the display will update soft keys and show menus, menu items, and current value of the menu item, depending on the specific programming function being performed.

## User Soft Keys (Normal Operating Mode)

There are four soft keys on the front of the unit just below the LCD screen that can be used to interact with the unit.

	<b>WARNING</b>
	Pressing these keys will change how the unit functions. Please thoroughly review the manual before using these keys or changing menu items.

	<b>NOTE</b>
	The unit can be programmed so that the User Soft Keys will not be displayed during normal operating mode (see <a href="#">Software Programming</a> section, menu item <a href="#">DISPL SOFTKEYS</a> ).

The list below contains soft keys that will appear at the display screen during normal operating mode, depending on the state of the unit.

<b>MENU</b>	Provides access to the menus when in the normal operating mode (see <a href="#">Software Programming</a> section).
<b>RESET</b>	Resets the alarm light, alarm contacts, and audible alarm when in a latched or non-automatic reset mode. If an alarm is reset before alarm conditions exited, the monitor or controller will reset the alarm but the alarm mode will be re-entered after the <a href="#">ALARM DELAY</a> .  Resets the emergency function after the emergency key has been pressed (see <a href="#">EMERGENCY</a> key).  Clears any displayed error messages.
<b>SETBACK</b>	The <b>SETBACK</b> soft key activates the setback or second control set point. In setback mode, the controller controls at the setback set point, the display indicates <b>SETBACK</b> , and the yellow light turns on.
<b>NORMAL</b>	The <b>NORMAL</b> soft key will appear if the unit has been placed into Setback mode. If the <b>NORMAL</b> soft key is pressed, the controller returns to normal control set point.

## Quick Keys

There are two Quick Keys on the front of the unit just below the Soft Keys. The Quick-Keys function as left and right arrows or to increase/decrease values.

## Operator Keys

There are two dedicated keys on the front of the unit that each provides a critical function.



### **MUTE key**

The **MUTE** key silences an audible alarm. The alarm remains silent until the MUTE TIMEOUT value has been reached or the unit returns to control set point. Pressing the **MUTE** key twice will permanently mute the alarm.

#### NOTE

You can program the unit so that the audible alarm cannot be muted (see menu item [MUTE\\_BUTTON](#)).



### **EMERGENCY key**

The **EMERGENCY** key puts the controller into emergency mode. The controller maximizes the exhaust flow and face velocity (if applicable) by modulating the damper or venturi valve to full open position.

Pressing the **EMERGENCY** key will cause "**EMERGENCY**" to appear on the display, the red alarm light to flash on and off, and the audible alarm to beep intermittently. To return to control mode press the **EMERGENCY** key or the **RESET** key.



#### NOTE

The Model FHM10 monitor and FHC50 controller can be configured so the audible alarm is silenced during emergency mode. See menu item [EMERGENCY\\_AUD](#).

## USB Port

There is a USB port at the bottom of the case. This USB port can be used with TSI®'s Fume Hood Configuration Software.

---

## Alarms

The Model FHC50 controller has visual (red light) and audible alarms to inform you of changing fume hood conditions. The alarm levels (set points) are determined by facilities staff, which could be Engineering, Industrial Hygiene, or a facilities group depending on how the safety staff is organized.

The alarms, audible and visual, will activate whenever the preset alarm level is reached. The alarms will activate if the face velocity is low or inadequate, high or too great, or when the exhaust airflow is too low or too high (need optional flow device installed). When the fume hood is operating safely, no alarms will sound.

**Example:** The low alarm is preset to activate when the face velocity falls below 60 ft/min. When the face velocity drops below 60 ft/min, the audible and visual alarms activate. The alarms turn off (when set to unlatched) when the unit returns to the safe range, which is defined as 20 ft/min greater than alarm set point (80 ft/min).

## Visual Alarm

The red light on the front of the unit indicates an alarm condition. The red light is on for all alarm conditions, low alarms, high alarms, and emergency. The light is on continuously in a low or high alarm condition, and flashes in an emergency condition.

## Audible Alarm—EMERGENCY key

When the **EMERGENCY** key is pressed, the audible alarm beeps intermittently until the **EMERGENCY** or **RESET** key is pressed terminating the emergency alarm. Pressing the **MUTE** key will silence the emergency alarm, although the red LED will continue to flash (if enabled - see menu item [MUTE KEY](#)).

	<p style="text-align: center;"><b>NOTE</b></p> <p>The Model FHM10 monitor and FHC50 controller can be configured so the audible alarm is silenced during emergency mode. See menu item <a href="#">EMERGENCY_AUD</a>.</p>
---	---

## Audible Alarms—All Except Emergency

The audible alarm is continuously on in all low and high alarm conditions. The audible alarm can be silenced by pressing the **MUTE** key (if enabled - see menu item [MUTE BUTTON](#)).

If the audible alarm has been muted, the alarm is silenced for a configurable period of time (see menu item [MUTE TIMEOUT](#)) or the measurement returns to the safe range. The safe range is 20 ft/min (50 cfm) above the low alarm set point and 20 ft/min (50 cfm) below the high alarm set point.

The audible and visual alarms can be programmed to either automatically turn off when the unit returns to the safe range or to stay in alarm until the **RESET** key is pressed (See menu item [ALARM\\_RESET](#)).

---

## Before Calling TSI<sup>®</sup> Incorporated

This manual should answer most questions and resolve most problems you may encounter. If you need assistance or further explanation, contact your local TSI<sup>®</sup> representative or TSI<sup>®</sup>. TSI is committed to providing high quality products backed by outstanding service.

Please have the following information available prior to contacting your authorized TSI Manufacturer's Representative or TSI:

- Model number of unit\*      FHC50-\_\_\_\_ or FHM10-\_\_\_\_
- Software revision level\*
- Facility where unit is installed

\* Can be determined by entering the [SELF TEST](#) item under the [Diagnostics](#) menu.

Due to the different Model FHM10 monitors and Model FHC50 controllers available, the above information is needed to accurately answer your questions.

For the name of your local TSI representative or to talk to TSI service personnel, please call TSI at (800) 680-1220 (U.S. and Canada) or (001 651) 490-2811 (other countries).

Prior to shipping any components to TSI for service or repair, please utilize our convenient Service Request Form, which is available online at <http://service.tsi.com>.

*(This page intentionally left blank)*



## Part Two

---

### Technical Section

The Fume Hood Controller is ready to use after being properly installed and calibrated. The calibration procedure should take less than 15 minutes. Figure 2 shows the Digital Interface Module (DIM) which is programmed with a default configuration that can be easily modified to fit your application.

The technical section is separated into six parts that cover all aspects of the unit. Each section is written as independently as possible to minimize flipping back and forth through the manual for an answer.

The [Software Programming](#) section explains the programming keys on the DIM. In addition, the programming sequence is described, which is the same regardless of the menu item being changed. At the end of this section is an example of how to program the DIM.

The [Hardware Configurations](#) section covers the different ways the DIM can be configured to accommodate the hardware and sequence of operation that is required. This section explains how to compare the installed hardware to the necessary settings that are needed.

The [Menu and Menu Items](#) section lists all of the software items available to program and change. The items are grouped by menu which means all set points are in one menu, control signal items in another, etc. The menu items and all related information is provided including; programming name, description of menu item, range of programmable values, and how the unit shipped from the factory (default value).

The [Calibration](#) section describes the required procedure to calibrate the controller. This section explains how to compare the controller's velocity reading to a portable thermal anemometer and then adjust the zero and span to establish an accurate calibration. This section also describes how to zero a TSI® flow station transducer (if installed).

The [Maintenance and Repair Part](#) section covers all routine maintenance of equipment, along with a list of repair parts.

The [Troubleshooting](#) section is split into two areas: mechanical operation of the unit and system performance. Many external variables will affect how the unit functions so it is critical to first determine if the system is having mechanical problems—i.e., no display on unit, alarms do not function, damper does not modulate, etc. If no mechanical problems exist, look for performance problems (i.e., does not seem to read correctly, display fluctuates, etc.). The first step is to determine that the system is mechanically operating correctly, followed by modifying the configuration to eliminate the performance problems.



**Figure 2**

## Software Programming

Programming the Model FHC50 controller is quick and easy if the programming keys are understood, and the proper keystroke procedure is followed. The programming keys are defined first, followed by the required keystroke procedure. At the end of this section is a programming example.

NOTE	
	<p>It is important to note that the unit is always operating (except when checking the <a href="#">CONTROL OUTPUT</a>) when programming. When a menu item value is changed, the new value takes effect <i>immediately</i> after saving the change, not when the unit returns to normal operating mode.</p> <p>This section covers programming the instrument through the keypad and display. If programming through network communications (see <a href="#">Appendix B</a>), use the host computer's procedure. The changes take place immediately upon saving data in the instrument.</p>

### Programming Keys

The four vertical programming soft keys (refer to Figure 3) are used to program or configure the unit to fit your particular application. Programming the instrument will change how the unit functions, so thoroughly review the menu items to be changed.



Figure 3

### Menu Soft Keys

The list below contains soft keys that will appear while in the menu structures.

<b>ESC</b>	The <b>ESC</b> soft key is used to escape from the current menu or menu item, and will also cancel any change that is currently being made to an item value.				
<b>▲/▼</b>	<p>The <b>▲/▼</b> soft keys are used to scroll through the menus, menu items, and through the range of item values that can be selected. Depending on the item type the values may be numerical, specific properties (on/off), or a list of options.</p> <table border="1" style="width: 100%; background-color: #0070C0; color: white;"> <thead> <tr> <th colspan="2" style="text-align: center;">NOTE</th> </tr> </thead> <tbody> <tr> <td colspan="2">When programming a numerical menu item, continuously pressing the arrow key will scroll through the values faster than if arrow key is pressed and released.</td> </tr> </tbody> </table>	NOTE		When programming a numerical menu item, continuously pressing the arrow key will scroll through the values faster than if arrow key is pressed and released.	
NOTE					
When programming a numerical menu item, continuously pressing the arrow key will scroll through the values faster than if arrow key is pressed and released.					
<b>↵</b>	<p>The <b>↵</b> (<b>ENTER</b>) soft key performs three functions.</p> <ol style="list-style-type: none"> <li>1. Provides access to specific menus and submenus.</li> <li>2. Provides access to menu items.</li> <li>3. Saves data.</li> </ol>				

## Quick Keys

There are two dedicated adjustment keys on the front of the unit (refer to Figure 3) that become active when accessing a menu item. These keys change choices of a menu item while that item is highlighted on the display. The left adjustment key will decrease the value of an item, and the right adjustment key will increase the value of an item. If there are no choices available for a particular menu item, or if that menu item is for reference only, the adjustment keys will have no effect.

The item data will be automatically saved when either of the ▲/▼ soft keys are used to highlight a different menu item, or when the ↵ (**ENTER**) soft key is pressed. Pressing the **ESC** soft key while the menu item is still highlighted will discard changes and restore the item to its last saved value.

### NOTE

When programming a numerical menu item, continuously pressing a quick adjustment key will scroll through the values faster than if they key is repeatedly pressed and released.

## Keystroke Procedure

The keystroke operation is consistent for all menus. The keystroke sequence is the same regardless of the menu item being changed.

1. Press the **MENU** soft key from the normal operating screen to access the main menu.
2. Use the ▲/▼ soft keys to scroll through the menu choices until the item you want to access is highlighted.
3. Press the ↵ (**ENTER**) soft key to access chosen menu.
4. The menu selected is now displayed at the top of the display, followed by a list of available menu items. Use the ▲/▼ soft keys to scroll through the menu items. Scroll through the menu items until desired item is highlighted.

### Standard Data Entry Method

- 5a. Press the ↵ (**ENTER**) soft key to access chosen menu item. The top line of display shows menu item selected, and below that shows current menu item value. Use the ▲/▼ soft keys to change menu item value.
- 6a. Save the new value by pressing the ↵ (**ENTER**) soft key (pressing the **ESC** soft key will exit out of menu item without saving data). The display will automatically return to the current menu.

### Quick Data Entry Method

- 5b. With the desired menu item highlighted, use the quick adjustment keys to change menu item value.
- 6b. Save the new value by pressing the ↵ (**ENTER**) soft key OR by using the ▲/▼ soft keys to highlight a different menu item (pressing the **ESC** soft key will exit out of menu item without saving data).

7. Press the **ESC** soft key to exit current menu and return to main menu.
8. Press the **ESC** soft key again to return to normal instrument operation.

If more than one item is to be changed, skip steps 7 and 8 until all changes are complete. If more items in the same menu are to be changed, scroll to them after saving the data (step 6a or 6b). If other menus need to be accessed, press the **MENU** key once to access list of menus (the instrument is now at step 2 of the keystroke sequence).

## Programming Example

The following example demonstrates the keystroke sequence. In this example the low alarm set point will be changed from 80 ft/min to 60 ft/min.

- Unit is in normal operation.

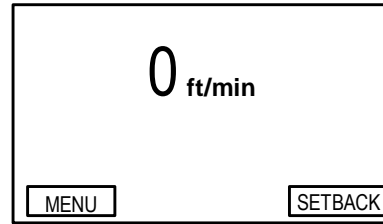

- Press the **MENU** key to gain access to the menus.



The first menu choices are displayed.

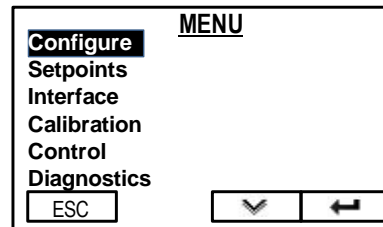

- Press the **▼** and **↵** keys to access the **SETPOINTS** menu.
- Press the **▼** soft key until Lo Vel Alarm is highlighted.

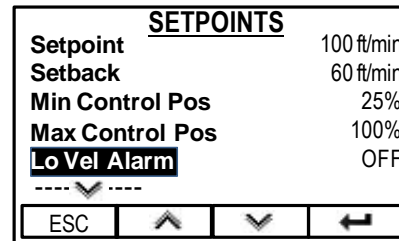

### Standard Data Entry Method

- Press the **↵** key to access the Lo Vel Alarm screen.

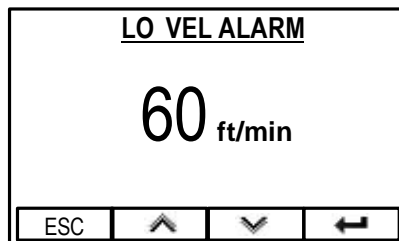

### Quick Data Entry Method

Press the Quick-Adjust keys to change the alarm set point. Then press the **▲** or **▼** soft key to save the change.

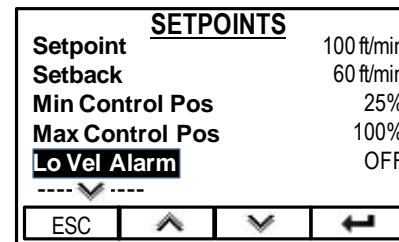

- Press the **▲/▼** soft keys to change the alarm set point to 60 fpm, then press the **↵** key to save the new set point.

## Hardware Configurations

The Model FHM10 Fume Hood Monitor can be field-configured to monitor face velocity or flow rates, while the Model FHC50 Fume Hood Controller can be field-configured to control face velocity or flow rates. These models feature a configuration wizard to easily select the desired monitor or controller configuration.

The following tables will assist in determining which configuration will need to be programmed into the controller for proper operation. You can also use the tables as a check to ensure that the monitor or controller has been properly configured after changing default settings from the configuration wizard.

Please note that in some applications, there may be a flow sensing device present at the fume hood exhaust (flow station, venturi valve linear feedback, etc.), but which is not used by the fume hood controller. The flow sensing information may be intended only to be received by a room controller for flow tracking purposes. This will not affect the operation of the fume hood controller provided it is configured correctly.

### Model FHC50 Controller Modes

SETTING	NORMAL & SETBACK CONTROL TYPES	FACE VELOCITY METHOD	FLOW METHOD	PARAMETERS DISPLAYED	ANALOG OUTPUT	INPUT 1
1) SIDEWALL ONLY	Face Velocity	Sidewall Sensor	N/A	Velocity	Velocity	Night Setback**
2) SIDEWALL PRESSFLOW	Face Velocity With Flow Limits	Sidewall Sensor	Pressure-Based Flow Station	Velocity	No Change*	Night Setback**
3) SIDEWALL LINEARFLOW	Face Velocity With Flow Limits	Sidewall Sensor	Linear Flow Station	Velocity	No Change*	Night Setback**
4) SIDEWALL LOMVENTURI	Face Velocity With Flow Limits	Sidewall Sensor	Venturi Valve With LOM Feedback	Velocity	No Change*	Night Setback**
5) SIDEWALL 6PTVENTURI	Face Velocity With Flow Limits	Sidewall Sensor	Venturi Valve (No Feedback)	Velocity	No Change*	Night Setback**
6) FLOW PRESSFLOW	Flow	N/A	Pressure-Based Flow Station	Flow	Flow Rate	Night Setback**
7) FLOW LINEARFLOW	Flow	N/A	Linear Flow Station	Flow	Flow Rate	Night Setback**
8) FLOW LOMVENTURI	Flow	N/A	Venturi Valve With LOM Feedback	Flow	Flow Rate	Night Setback**

SETTING	NORMAL & SETBACK CONTROL TYPES	FACE VELOCITY METHOD	FLOW METHOD	PARAMETERS DISPLAYED	ANALOG OUTPUT	INPUT 1
9) FLOW 6PTVENTURI	Flow	N/A	Venturi Valve (No Feedback)	Flow	Flow Rate	Night Setback**
10) SASHPOS LOMVENTURI	Face Velocity With Flow Limits	Sash-Position	Venturi Valve With LOM Feedback	Velocity	No Change*	Vertical Sash Sensor
11) N/A	N/A	N/A	N/A	N/A	N/A	N/A
12) SIDEWALL SASHCALC-FLOW	Face Velocity With Flow Limits	Sidewall Sensor	Calculated from measured Sash Opening and Sidewall Sensor	Velocity	No Change*	Vertical Sash Sensor

### Model FHM10 Fume Hood Monitor Modes

SETTING	SIDEWALL SENSOR	FLOW METHOD	PARAMETERS DISPLAYED	ANALOG OUTPUT	INPUT 1
1) SIDEWALL VELMONITOR	Enabled	N/A	Velocity	Velocity	Night Setback**
2) PRESSFLOW MONITOR	Disabled	Pressure-Based Flow Station	Flow	Flow Rate	Night Setback**
3) LINEARFLOW MONITOR	Disabled	Linear Flow Station	Flow	Flow Rate	Night Setback**
4) LOMVENTURI FLOWMONITOR	Disabled	Venturi Valve With LOM Feedback	Flow	Flow Rate	Night Setback**

\* Analog Output is reset if previous setting would now be invalid. Otherwise, Analog Output is not changed.

\*\* Input 1 is changed to Night Setback only if it was previously set to Vertical Sash Sensor.

## Menu and Menu Items

The Model FHM10 monitor and Model FHC50 controller are very versatile devices which can be configured to meet your specific application. This section lists all of the menu items available to program and change (except diagnostics menu). Changing items is accomplished by using the keypad or through communications with the Building Automation System. If you are unfamiliar with the keystroke procedure please see [Software Programming](#) section for a detailed explanation. This section provides the following information:

- Complete list of menus and all menu items.
- Gives the menu or programming name.
- Defines each menu item's function; what it does, how it does it, etc.
- Gives the range of values that can be programmed.
- Gives default item value (how it shipped from factory).

The menus covered in this section are divided into groups of related items to ease programming. As an example all set points are in one menu, alarm information in another, etc. The manual follows the menus as programmed in the controller. The menu items are always grouped by menu and then listed in menu item order, not alphabetical order. Figure 4 shows the Model FHM10 monitor menu items, while Figure 5 shows the Model FHC50 controller menu items.

<b><u>CONFIGURE</u></b>	<b><u>SETPOINTS</u></b>	<b><u>CALIBRATION</u></b>	<b><u>DIAGNOSTICS**</u></b>
CONFIG WIZARD	LO VEL ALARM	VEL SENSOR ZERO	VEL SENSOR INPUT
VEL SENSOR	HI VEL ALARM	VEL SENSOR SPAN	FLOW STATION INPUT
FLOW DEVICE	LO FLOW ALARM	CALIBRATE FLOW	SHOW FLOW
DISPL SOFTKEYS	HI FLOW ALARM		ANALOG OUT
DISPLAY MEAS	SETB LOVEL ALARM		ALARM RELAY A
DISPLAY AVG	SETB HIFLO ALARM		ALARM RELAY B
DISPLAY UNITS	SETB LOFLO ALARM		IN1 SASH CONTACT
ALARM RESET	SETB HIFLO ALARM		IN2 EMERG PURGE
EMERGENCY AUD			IN3 NIGHT SETBACK
MUTE BUTTON			SELF TEST
MUTE TIMEOUT	<b><u>INTERFACE</u></b>		RESET SETTINGS
ALARM DELAY	NET PROTOCOL		RESET ALL CALIBS
ANALOG OUT TYPE	NETWORK SETTINGS*		
ANALOG OUT SIG			
ANALOG OUT F.S.			
RELAYS OUT			
RELAY SEL B			
INPUT SEL 1			
INPUT SEL 2			
INPUT SEL 3			
NUMBER FORMAT			
CONTRAST			
ACCESS CODE			

**Figure 4. Menu Items – Model FHM10 Monitor**

\* Items in **NETWORK SETTINGS** submenu depend on **NET PROTOCOL** setting. See [NETWORK SETTINGS](#) item description for details.

\*\* Menu items located in [Troubleshooting](#) section.

## CONFIGURE

CONFIG WIZARD  
NORM CTRL MODE  
SETB CTRL MODE  
VEL SENSOR  
FLOW DEVICE  
DISPL SOFTKEYS  
DISPLAY MEAS  
DISPLAY AVG  
DISPLAY UNITS  
ALARM RESET  
EMERGENCY AUD  
MUTE BUTTON  
MUTE TIMEOUT  
ALARM DELAY  
ANALOG OUT TYPE  
ANALOG OUT SIG  
ANALOG OUT F.S.  
RELAYS OUT  
RELAY SEL A  
RELAY SEL B  
INPUT SEL 1  
INPUT SEL 2  
INPUT SEL 3  
NUMBER FORMAT  
CONTRAST  
SPECIALS MENU  
ACCESS CODE

## CONTROL

SENSITIVITY  
SPEED  
CONTROL SIG  
KC VALUE  
TI VALUE

## SETPOINTS

SETPOINT  
SETBACK  
SETB CNTL POS  
MIN CONTROL POS  
MAX CONTROL POS  
MIN FLOW  
MAX FLOW  
LO VEL ALARM  
HI VEL ALARM  
LO FLOW ALARM  
HI FLOW ALARM  
SETB LOVEL ALARM  
SETB HIVEL ALARM  
SETB LOFLO ALARM  
SETB HIFLO ALARM  
HI SASH POS ALARM  
DAMPER ALARM

## DIAGNOSTICS\*\*\*

CONTROL OUT  
VEL SENSOR INPUT  
SHOW FACE VEL  
FLOW STATION ANALOG INPUT  
SHOW FLOW  
ANALOG OUT  
ALARM RELAY A  
ALARM RELAY B  
IN1 SASH CONTACT\*\*\*\*  
SHOW SASH%OPEN  
SHOW SASH AREA  
IN2 EMERG PURGE\*\*\*\*  
IN3 NIGHT SETBACK\*\*\*\*  
SELF TEST  
RESET SETTINGS  
RESET ALL CALIBS

## INTERFACE

NET PROTOCOL  
NETWORK  
SETTINGS\*\*

## CALIBRATION

VEL SENSOR ZERO  
VEL SENSOR SPAN  
CALIBRATE FLOW  
BALANCE MODE  
SASH CAL CLOSED  
SASH CAL OPEN  
SASH AREA OPEN  
SASH AREA CLOSED

### BALANCE MODE\*

DESIRED FLOW  
FLOW KFACTOR  
UNCORRECTED  
FLOW  
KF USED  
FLOW \* KF

**Figure 5: Menu Items – Model FHC50 Controller**

\* **BALANCE FLOW** submenu only appears if flow sensor is enabled (**FLOW DEVICE** not set to **NONE**).

\*\* Items in **NETWORK SETTINGS** submenu depend on **NET PROTOCOL** setting. See [NETWORK SETTINGS](#) item description for details.

\*\*\* Menu items located in [Troubleshooting](#) section.

\*\*\*\* Menu item name depends on **INPUT SEL 1**, **INPUT SEL 2** and **INPUT SEL 3** in **CONFIGURE** menu.



CONFIGURE MENU				
MENU ITEM <i>Monitor/ Controller</i>	SOFTWARE NAME	ITEM DESCRIPTION	ITEM RANGE	DEFAULT VALUE
CONFIGURATION WIZARD  <i>FHM10 and FHC50</i>	CONFIG WIZARD  	<p>The <b>CONFIG WIZARD</b> item is used to select the desired sequence of operations. Using the <b>CONFIG WIZARD</b> will also configure inputs and outputs for the selected sequence of operations. Refer to the <a href="#">Hardware Configurations</a> section to see the inputs and outputs.</p> <div style="border: 1px solid black; background-color: #0070C0; color: white; text-align: center; padding: 2px;"><b>NOTE</b></div> <p>Use the <b>CONFIG WIZARD</b> to change the sequence of operations. Some settings can only be changed through the <b>CONFIG WIZARD</b>.</p>	FHC50 Controller: 1) Sidewall only 2) Sidewall PressFlow 3) Sidewall LinearFlow 4) Sidewall LOMVenturi 5) Sidewall 6ptVenturi 6) Flow PressFlow 7) Flow LinearFlow 8) Flow LOMVenturi 9) Flow 6ptVenturi 10) SashPos LOMVenturi 12) Sidewall SashCalcFlow  FHM10 Monitor: 1) Sidewall VelMonitor 2) PressFlow Monitor 3) LinearFlow Monitor 4) LOMVenturi FlowMonitor	FHC50 Controller: 1) Sidewall only  FHM10 Monitor: 1) Sidewall VelMonitor

CONFIGURE MENU				
MENU ITEM <i>Monitor/ Controller</i>	SOFTWARE NAME	ITEM DESCRIPTION	ITEM RANGE	DEFAULT VALUE
NORMAL CONTROL MODE <i>FHC50 Only</i>	NORM CTRL MODE	<p>The <b>NORM CTRL MODE</b> item selects the measurement on which the control function is based during <b>NORMAL</b> (Occupied) Mode.</p> <p>If this item is set to:</p> <p><b>VelSidewall</b> The controller will control face velocity using a sidewall sensor.</p> <p><b>VelSashPos</b> The controller will control face velocity using a sash sensor and venturi valve with LOM feedback.</p> <p><b>VelSide+Sash</b> The controller will control face velocity using both the sash sensor with LOM feedback and a sidewall sensor.</p> <p><b>Flow</b> The controller will control flow using the flow device (see menu item <a href="#">FLOW DEVICE</a>).</p>	VelSidewall VelSashPos VelSide+Sash Flow	VelSideWall

CONFIGURE MENU				
MENU ITEM <i>Monitor/ Controller</i>	SOFTWARE NAME	ITEM DESCRIPTION	ITEM RANGE	DEFAULT VALUE
SETBACK CONTROL MODE  <i>FHC50 Only</i>	SETB CTRL MODE	<p>The <b>SETB CTRL MODE</b> item selects the measurement on which the control function is based during <b>SETBACK</b> (Unoccupied) Mode.</p> <p>If this item is set to:</p> <p><b>VelSidewall</b> The controller will control face velocity using a sidewall sensor.</p> <p><b>VelSashPos</b> The controller will control face velocity using a sash sensor and venturi valve with LOM feedback.</p> <p><b>VelSide+Sash</b> The controller will control face velocity using both the sash sensor with LOM feedback and a sidewall sensor.</p> <p><b>Flow</b> The controller will control flow using the flow device (see menu item <a href="#">FLOW DEVICE</a>).</p> <p><b>FixedPos</b> The controller will hold the damper or venturi valve at a fixed percentage at all times during <b>SETBACK</b> Mode, while ignoring the measured face velocity or flow for control purposes. All <b>SETBACK</b>-related alarms are still active with this configuration, unless set to <b>OFF</b>.</p> <div style="border: 1px solid black; background-color: #0056b3; color: white; text-align: center; padding: 2px;"><b>NOTE</b></div> <p>To shut down a fume hood with the Model FHC50 controller, set the <b>SETB CTRL MODE</b> item to <b>FixedPos</b> and the <b>SETBACK POS</b> item to 0%.</p>	VelSidewall VelSashPos VelSide+Sash Flow FixedPos	VelSideWall
VELOCITY SENSOR  <i>FHM10 and FHC50</i>	VEL SENSOR	<p>The <b>VEL SENSOR</b> item shows if the velocity sensor input is enabled. If this item shows <b>Enabled</b>, then the controller will look for and use an installed sidewall sensor. If this item shows <b>Disabled</b>, the controller will not look for or use an installed sidewall sensor.</p>	Enabled Or Disabled	None (Read-only value)



<b>CONFIGURE MENU</b>				
<b>MENU ITEM</b> <i>Monitor/ Controller</i>	<b>SOFTWARE NAME</b>	<b>ITEM DESCRIPTION</b>	<b>ITEM RANGE</b>	<b>DEFAULT VALUE</b>
FLOW DEVICE <i>FHM10 and FHC50</i>	FLOW DEVICE	<p>The <b>FLOW DEVICE</b> item shows the type of air flow device being used for flow based measurements and control. Choose:</p> <p><b>None</b> No flow device installed, or there is to be no flow information used by the controller.</p> <p><b>Lin Flo Sta</b> When a linear output flow station, typically thermal anemometer based, is installed.</p> <p><b>Press Flo Sta</b> When a TSI® flow station with pressure transducer is installed.</p> <p><b>LOM Venturi</b> When a TSI® venturi valve with a Linear Output Module with Linear Feedback is installed.</p> <p><b>6pt Venturi</b> When a standard TSI® venturi valve (without Linear Output Module) is installed.</p> <p><b>Calculated</b> When both a sidewall velocity sensor and a sash sensor are installed, and the flow rate is to be calculated using the data obtained from the two sensors (face velocity X sash open area = flow rate)</p>	FHC50 Controller: None Lin Flo Sta Press Flo Sta LOM Venturi 6pt Venturi Calculated FHM10 Monitor: None Lin Flo Sta Press Flo Sta LOM Venturi 6pt Venturi	None (Read-only value)
DISPLAY SOFTKEYS <i>FHM10 and FHC50</i>	DISPL SOFTKEYS  	<p>The <b>DISPL SOFTKEYS</b> item selects if the menu and programming soft keys are to be displayed during normal operating mode.</p> <p style="text-align: center;"><b>NOTE</b></p> <p>Press left and right quick-keys and right-most soft key simultaneously to gain access to menu system if <b>DISPL SOFTKEYS</b> is set to <b>OFF</b>.</p>	ON OFF	ON

<b>CONFIGURE MENU</b>				
<b>MENU ITEM Monitor/ Controller</b>	<b>SOFTWARE NAME</b>	<b>ITEM DESCRIPTION</b>	<b>ITEM RANGE</b>	<b>DEFAULT VALUE</b>
<b>DISPLAY MEASUREMENT</b> <i>FHM10 and FHC50</i>	<b>DISPLAY MEAS</b>	<p>The <b>DISPLAY MEAS</b> item selects which measurements will be presented on the display during normal operating mode. Use the <b>DISPLAY UNITS</b> item to choose the units of measure:</p> <p><b>Vel</b> Displays only the current face velocity.</p> <p><b>Vel, Flow</b> Displays both the current face velocity and the current flow.</p> <p><b>Flow</b> Displays only the current flow.</p> <p><b>None</b> Does not display face velocity or flow during normal operating mode.</p>	Vel Vel, Flow Flow None	Vel
<b>DISPLAY AVERAGE</b> <i>FHM10 and FHC50</i>	<b>DISPLAY AVG</b>	<p>The <b>DISPLAY AVG</b> item selects the display's running average period. The display-averaging period is the length of time the face velocity has been averaged before being displayed. The <b>DISPLAY AVG</b> item value may be set between 0.5 and 40 seconds. The higher the averaging value, the more stable the display.</p>	0.5, 1, 2, 3, 5, 10, 20, or 40 seconds	5 seconds
<b>DISPLAY UNITS</b> <i>FHM10 and FHC50</i>	<b>DISPLAY UNITS</b>	<p>The <b>DISPLAY UNITS</b> item selects the unit of measure that the controller displays all velocity and flow related menu items: set points, alarms, calibration, etc.</p>	ft/min, cfm m/s, m <sup>3</sup> /h m/s, l/s	ft/min, cfm
<b>ALARM RESET</b> <i>FHM10 and FHC50</i>	<b>ALARM RESET</b>	<p>The <b>ALARM RESET</b> item selects how the alarms terminate after the unit returns to control set point. <b>UNLATCHED</b> (alarm follow) automatically resets the alarm when the face velocity is 20 ft/min (50 cfm for flow alarms) greater than the low alarm set point, or 20 ft/min (50 cfm for flow alarms) below the high alarm set point. <b>LATCHED</b> requires the staff to press the <b>RESET</b> key to clear alarms. The <b>ALARM RESET</b> affects the audible alarm, visual alarm, and relay output, which means all are latched or unlatched.</p>	LATCHED or UNLATCHED	UNLATCHED

<b>CONFIGURE MENU</b>						
<b>MENU ITEM Monitor/ Controller</b>	<b>SOFTWARE NAME</b>	<b>ITEM DESCRIPTION</b>	<b>ITEM RANGE</b>	<b>DEFAULT VALUE</b>		
EMERGENCY AUDIBLE ALARM <i>FHM10 and FHC50</i>	EMERGENCY AUD  	The <b>EMERGENCY AUD</b> menu item determines if the audible alarm sounds when the controller enters emergency mode. If set to <b>ON</b> , the audible alarm will sound intermittently to indicate an emergency. If set to <b>OFF</b> , the audible alarm will not sound in emergency mode.  <table border="1" data-bbox="642 488 1402 605"> <thead> <tr> <th><b>NOTE</b></th> </tr> </thead> <tbody> <tr> <td>The <b>EMERGENCY AUD</b> item does not affect messages on the display or operation of the red LED.</td> </tr> </tbody> </table>	<b>NOTE</b>	The <b>EMERGENCY AUD</b> item does not affect messages on the display or operation of the red LED.	ON or OFF	ON
<b>NOTE</b>						
The <b>EMERGENCY AUD</b> item does not affect messages on the display or operation of the red LED.						
MUTE BUTTON <i>FHM10 and FHC50</i>	MUTE BUTTON	The <b>MUTE BUTTON</b> item enables the mute button on the front of the controller. Select <b>ON</b> if the Audible Alarm can be muted from the keypad. Select <b>OFF</b> if the Audible Alarm cannot be muted.	ON OFF	ON		
MUTE TIMEOUT <i>FHM10 and FHC50</i>	MUTE TIMEOUT	The <b>MUTE TIMEOUT</b> item sets the length of time the audible alarm will be silenced if the mute button is pressed ( <b>MUTE BUTTON</b> must be set to <b>ON</b> ). The <b>MUTE TIMEOUT</b> can be set from 1 to 60 minutes or Permanent. If Permanent is selected, the audible alarm will not be activated during the current alarm, but the audible alarm will reset when the alarm clears.	1 to 60 Minutes Permanent	1 Minute		
ALARM DELAY <i>FHM10 and FHC50</i>	ALARM DELAY	The <b>ALARM DELAY</b> item sets the period of time the face velocity (flow) must be above the high alarm set point or below the low alarm set point before the controller enters alarm mode. Use the <b>ALARM DELAY</b> function to avoid momentary, nuisance alarms.	5 to 120 seconds	5 seconds		
ANALOG OUTPUT TYPE <i>FHM10 and FHC50</i>	ANALOG OUT TYPE	The <b>ANALOG OUT TYPE</b> item selects the measurement that the <b>ANALOG OUTPUT SIGNAL</b> will represent.	FHC50 Controller: Velocity Flow rate %Sash Open  FHM10 Monitor: Velocity Flow rate	Velocity		
ANALOG OUTPUT SIGNAL <i>FHM10 and FHC50</i>	ANALOG OUT SIG	The <b>ANALOG OUT SIG</b> item selects the type of analog <i>Velocity, Flow, or %Sash Open</i> signal output (not control output signal). See menu item <a href="#">ANALOG OUT TYPE</a> .	0 to 10 VDC or 4 to 20 mA	0 to 10 VDC		

CONFIGURE MENU						
MENU ITEM <i>Monitor/ Controller</i>	SOFTWARE NAME	ITEM DESCRIPTION	ITEM RANGE	DEFAULT VALUE		
ANALOG OUTPUT FULL SCALE <i>FHM10 and FHC50</i>	ANALOG OUT F.S.	The <b>ANALOG OUT F.S.</b> item selects the full scale range that the <b>ANALOG OUTPUT SIGNAL</b> will represent. If <b>ANALOG OUT TYPE</b> is set to velocity, the <b>ANALOG OUT F.S.</b> item can be set between 0 to 1000 ft/min. If <b>ANALOG OUT TYPE</b> is set to flow rate, the <b>ANALOG OUT F.S.</b> item can be set between 0 to 10,000 cfm. See menu item <a href="#">ANALOG OUT TYPE</a> . If <b>ANALOG OUT TYPE</b> is set to % Sash Open, the <b>ANALOG OUT F.S.</b> is set to 100%.	0 to 1000 ft/min <i>or</i> 0 to 10000 cfm <i>or</i> 100% to 105%	1000 ft/min		
RELAY OUTPUT DIRECTION <i>FHM10 and FHC50</i>	RELAYS OUT  	The <b>RELAYS OUT</b> item configures the state of the alarm relays. Select <b>OK=OPEN</b> for normally open (N.O.) relays that close during alarm conditions. Select <b>OK=CLOSED</b> for normally closed (N.C.) relays that open during alarm conditions.  <table border="1" data-bbox="642 727 1402 813"> <tr> <th>NOTE</th> </tr> <tr> <td>Relays will always close during power loss conditions.</td> </tr> </table>	NOTE	Relays will always close during power loss conditions.	OK = OPEN <i>or</i> OK = CLOSED	OK = OPEN
NOTE						
Relays will always close during power loss conditions.						
RELAY OUTPUT 1 SELECT <i>FHM10 and FHC50</i>	RELAY SEL A	The <b>RELAY SEL A</b> item shows the desired alarm output to be used with Relay Contact Output 1.	Low Alarm	None (Read-only value)		
RELAY OUTPUT 2 SELECT <i>FHM10 and FHC50</i>	RELAY SEL B	The <b>RELAY SEL B</b> item selects the desired alarm output to be used with Relay Contact Output 2. Relay B can be set to toggle the relay when the unit is in high alarm, high sash alarm, setback mode, or damper alarm setpoint.	FHM10: High Alarm, Setback, Sash Open FHC50: High Alarm, High Sash, Setback, Damper Open	High Alarm		

<b>CONFIGURE MENU</b>				
<b>MENU ITEM Monitor/ Controller</b>	<b>SOFTWARE NAME</b>	<b>ITEM DESCRIPTION</b>	<b>ITEM RANGE</b>	<b>DEFAULT VALUE</b>
INPUT SELECT 1 INPUT SELECT 2 INPUT SELECT 3 <i>FHM10 and FHC50</i>	INPUT SEL 1 INPUT SEL 2 INPUT SEL 3	<p>The <b>INPUT SEL #</b> item selects the desired input type to be used with the corresponding input terminals.</p> <p><b>Night Setb</b> Enables the input to be used with a switch/contact closure to enable night setback mode.</p> <p><b>Emerg Purge</b> Enables the input to be used with a switch/contact closure to enable emergency mode.</p> <p><b>Sash Contact</b> Enables the input to be used with a switch/contact closure to monitor the fume hood sash height.</p> <p><b>Sash Pos V</b> Enables the input to be used with a TSI® Vertical Sash Position sensor. This option applies to <b>INPUT SEL 1</b> Only. The <b>Sash Pos V</b> option is only available on the FHC50.</p>	Night Setb Emerg Purge Sash Contact Sash Pos V (INPUT 1 Only)	INPUT SEL 1: Night Setb INPUT SEL 2: Night Setb INPUT SEL 3: Emerg Purge
NUMBER FORMAT <i>FHM10 and FHC50</i>	NUMBER FORMAT	The <b>NUMBER FORMAT</b> menu item selects the way that numbers are displayed.	XX,XXX.YY XX.XXX,YY	XX,XXX.YY
DISPLAY CONTRAST <i>FHM10 and FHC50</i>	CONTRAST	The <b>CONTRAST</b> menu item changes the level of contrast on the display screen. Decreasing this value will decrease the contrast, and increasing this value will increase the contrast.	1 to 10	5
SPECIALS MENU <i>FHC50 Only</i>	SPECIALS MENU	The <b>SPECIALS MENU</b> item is used to set the Model FHC50 controller for certain custom configuration. Access to the <b>SPECIALS MENU</b> item is restricted with a password. Contact TSI® for information about these configurations.	N/A	N/A





CONFIGURE MENU				
MENU ITEM <i>Monitor/ Controller</i>	SOFTWARE NAME	ITEM DESCRIPTION	ITEM RANGE	DEFAULT VALUE
ACCESS CODE <i>FHM10 and FHC50</i>	ACCESS CODE	<p>The <b>ACCESS CODE</b> item selects whether an access code (pass code) is required to enter the menu items. The <b>ACCESS CODE</b> item prevents unauthorized access to a menu. If the <b>ACCESS CODE</b> is <b>OFF</b>, no code is required to enter the menu screens. Conversely, if the <b>ACCESS CODE</b> is <b>ON</b>, a code is required before the menu screens can be entered.</p> <div style="border: 1px solid black; background-color: #0070C0; color: white; text-align: center; padding: 2px;"><b>NOTE</b></div> <p>Entering the code when the <b>ACCESS CODE</b> item is <b>ON</b> disables the <b>ACCESS CODE</b> for a period of 15 minutes.</p>	ON or OFF	ON



SETPOINTS MENU				
MENU ITEM	SOFTWARE NAME	ITEM DESCRIPTION	ITEM RANGE	DEFAULT VALUE
CONTROL SETPOINT <i>FHC50 Only</i>	SETPOINT	<p>The <b>SETPOINT</b> item sets the control set point. The control set point can be for either face velocity or flow control, depending on the setting of menu item <b>NORMAL CONTROL MODE</b>. The FHC50 controller will maintain this set point when normal operating conditions exist.</p> <p>If <b>NORMAL CONTROL MODE</b> = VelSideWall, VELSashPos or VelSide+Sash, enter a face velocity set point between 60 to 980 ft/min.</p> <p>If <b>NORMAL CONTROL MODE</b> = Flow, enter a value between 0 and 10,000 cfm.</p>	60 to 980 ft/min <i>or</i> 0 to 10000 cfm	100 ft/min <i>or</i> 0 cfm

SETPOINTS MENU				
MENU ITEM	SOFTWARE NAME	ITEM DESCRIPTION	ITEM RANGE	DEFAULT VALUE
CONTROL SETBACK SETPOINT <i>FHC50 Only</i>	SETBACK	<p>The <b>SETBACK</b> item sets an alternate control set point, typically used when the laboratory is unoccupied. The <b>SETBACK</b> control set point can be for either face velocity or flow control, depending on the setting of menu item <b>SETBACK CONTROL MODE</b>. The FHC50 controller will maintain this set point when normal operating conditions exist.</p> <p>If <b>SETBACK CONTROL MODE</b> = VelSideWall, VELSashPos or VelSide+Sash, enter a value between 60 to 980 ft/min.</p> <p>If <b>SETBACK CONTROL MODE</b> = Flow, enter a value between 0 and 10,000 cfm.</p> <p>A <b>SETBACK</b> condition is initiated when the <b>SETBACK</b> key has been pressed, the <b>SETBACK</b> contact input has been closed, or a command is received through network communications.</p> <div style="background-color: #ff9900; text-align: center; padding: 2px;"><b>WARNING</b></div> <p>The Model FHC50 may not maintain the fume hood's containment at low <b>SETBACK</b> face velocities.</p>	0 to 980 ft/min or 0 to 10000 cfm	100 ft/min or 0 cfm
SETBACK CONTROL POSITION <i>FHC50 Only</i>	SETBACK CNTRL POS	<p>The <b>SETBACK CNTRL POS</b> item is used to program a setback mode fixed damper or venturi valve position. The menu item <b>SETBACK CONTROL MODE</b> must be set to <b>FIXED POS</b> to enable the <b>SETBACK CNTRL POS</b> menu item. During <b>SETBACK</b>, the controller will set the control output to the value programmed for <b>SETBACK CNTRL POS</b>.</p> <div style="background-color: #0056b3; color: white; text-align: center; padding: 2px;"><b>NOTE</b></div> <p>To shut down a fume hood with the Model FHC50 controller, set the <b>SETB CTRL MODE</b> item to Fixed Position and the <b>SETBACK CNTRL POS</b> item to 0%.</p> <div style="background-color: #ff9900; text-align: center; padding: 2px;"><b>WARNING</b></div> <p>The Model FHC50 may not maintain the fume hood's average face velocity or flow at the setback set point item value when a <b>SETBACK CNTRL POS</b> has been programmed. The average face velocity or exhaust flow may fall below the setback alarm value; this could result in a setback velocity or flow alarm condition.</p>	0 to 100%	100%

SETPOINTS MENU				
MENU ITEM	SOFTWARE NAME	ITEM DESCRIPTION	ITEM RANGE	DEFAULT VALUE
MINIMUM DAMPER POSITION SETPOINT <i>FHC50 Only</i>	MIN CONTROL POS	The <b>MIN CONTROL POS</b> item is used to set the minimum damper position. The minimum damper position allows the setting of a minimum airflow through the fume hood. When the fume hood exhaust volume needed to maintain the set face velocity is less than the set minimum damper position (typically sash closed), the damper maintains the minimum damper position. Closing the sash further will result in an increase in the face velocity above the control set point which may cause a high alarm.	0 to 100%	0% OPEN
MAXIMUM DAMPER POSITION SETPOINT <i>FHC50 Only</i>	MAX CONTROL POS	The <b>MAX CONTROL POS</b> item is used to set the maximum damper position. The maximum damper position allows the setting of a maximum airflow through the fume hood. When the fume hood exhaust volume needed to maintain the set face velocity is greater than the set maximum damper position (typically sash open), the damper maintains the maximum damper position. Opening the sash further will result in a decrease in face velocity, which may cause a low alarm indicating an unsafe hood condition exists.	0 to 100%	100% OPEN
MINIMUM FLOW SETPOINT <i>FHC50 Only</i>	MIN FLOW  	<p>The <b>MIN FLOW</b> item sets the minimum flow set point when the <b>NORMAL CONTROL MODE</b> is set to VelSidewall, VelSashPos or VelSide+Sash. When the fume hood exhaust reaches the minimum flow set point, as the fume hood sash is lowered, the controller will modulate the hood exhaust to maintain this minimum flow.</p> <p style="text-align: center;"><b>WARNING</b></p> <p>The Model FHC50 may not maintain the fume hoods average face velocity at the <b>SETPOINT</b> item value when a <b>MINIMUM FLOW</b> has been programmed. The average face velocity may exceed the <b>SETPOINT</b> item value, resulting in a <b>HIGH ALARM</b> condition.</p> <p style="text-align: center;"><b>NOTE</b></p> <p>The <b>MINIMUM FLOW</b> set point must be 50 cfm less than the <b>MAXIMUM FLOW</b> set point.</p>	OFF, 0 to 10,000 cfm	OFF

SETPOINTS MENU				
MENU ITEM	SOFTWARE NAME	ITEM DESCRIPTION	ITEM RANGE	DEFAULT VALUE
MAXIMUM FLOW SETPOINT <i>FHC50 Only</i>	MAX FLOW  	<p>The <b>MAX FLOW</b> item sets the maximum flow set point when the <b>NORMAL CONTROL MODE</b> is set to VelSidewall, VelSashPos or VelSide+Sash. When the fume hood exhaust reaches the maximum flow set point, as the fume hood sash is raised, the controller will modulate the hood exhaust damper to maintain this maximum flow.</p> <p style="text-align: center;"><b>WARNING</b></p> <p>The Model FHC50 may not maintain the fume hoods average face velocity at the <b>SETPOINT</b> item value when a <b>MAX FLOW</b> has been programmed. The average face velocity may fall below the SETPOINT item value, resulting in a <b>LOW ALARM</b> condition.</p> <p style="text-align: center;"><b>NOTE</b></p> <p>The <b>MAX FLOW</b> set point must be 50 cfm greater than the <b>MIN FLOW</b> set point.</p>	OFF, 0 to 10,000 cfm	OFF
LOW VELOCITY ALARM SETPOINT <i>FHM10 and FHC50</i>	LOW VEL ALARM	<p>The <b>LOW VEL ALARM</b> item sets the face velocity low alarm set point during Normal mode. A low alarm condition is defined as when the face velocity is less than the low alarm set point during Normal mode.</p> <p style="text-align: center;"><b>NOTE</b></p> <p>The <b>LOW VEL ALARM</b> must be at least 20 ft/min less than the <b>SETPOINT</b>.</p>	OFF, 5 to 980 ft/min	OFF
HIGH VELOCITY ALARM SETPOINT <i>FHM10 and FHC50</i>	HIGH VEL ALARM	<p>The <b>HIGH VEL ALARM</b> item sets the face velocity high alarm set point during Normal mode. A high alarm condition is defined as when the face velocity exceeds the high alarm set point during Normal mode.</p> <p style="text-align: center;"><b>NOTE</b></p> <p>The <b>HIGH VEL ALARM</b> must be at least 20 ft/min greater than the <b>SETPOINT</b>.</p>	OFF, 80 to 1000 ft/min	OFF

SETPOINTS MENU				
MENU ITEM	SOFTWARE NAME	ITEM DESCRIPTION	ITEM RANGE	DEFAULT VALUE
LOW FLOW ALARM SETPOINT <i>FHM10 and FHC50</i>	LO FLOW ALARM	The <b>LO FLOW ALARM</b> item sets the low flow alarm set point during Normal mode. A low flow alarm condition is defined as when the exhaust flow is less than the low flow alarm set point during Normal mode.	OFF, 0 to 10000 cfm	OFF
		<table border="1"> <tr> <td style="text-align: center;"><b>NOTE</b></td> </tr> <tr> <td>The <b>LO FLOW ALARM</b> must be at least 50 cfm less than the <b>SETPOINT</b>.</td> </tr> </table>		
<b>NOTE</b>				
The <b>LO FLOW ALARM</b> must be at least 50 cfm less than the <b>SETPOINT</b> .				
HIGH FLOW ALARM SETPOINT <i>FHM10 and FHC50</i>	HI FLOW ALARM	The <b>HI FLOW ALARM</b> item sets the high flow alarm set point during Normal mode. A high flow alarm condition is defined as when the exhaust flow is greater than the high flow alarm set point during Normal mode.	OFF, 0 to 10000 cfm	OFF
		<table border="1"> <tr> <td style="text-align: center;"><b>NOTE</b></td> </tr> <tr> <td>The <b>HI FLOW ALARM</b> must be at least 50 cfm greater than the <b>SETPOINT</b>.</td> </tr> </table>		
<b>NOTE</b>				
The <b>HI FLOW ALARM</b> must be at least 50 cfm greater than the <b>SETPOINT</b> .				
SETBACK LOW VELOCITY ALARM SETPOINT <i>FHM10 and FHC50</i>	SETB LEVEL ALARM	The <b>SETB LEVEL ALARM</b> item sets the face velocity low alarm set point during Setback mode. A setback low velocity alarm condition is defined as when the face velocity is less than the setback low velocity alarm set point during Setback mode.	OFF, 5 to 980 ft/min	OFF
		<table border="1"> <tr> <td style="text-align: center;"><b>NOTE</b></td> </tr> <tr> <td>The <b>SETB LEVEL ALARM</b> must be at least 20 ft/min less than the <b>SETBACK</b> set point.</td> </tr> </table>		
<b>NOTE</b>				
The <b>SETB LEVEL ALARM</b> must be at least 20 ft/min less than the <b>SETBACK</b> set point.				
SETBACK HIGH VELOCITY ALARM SETPOINT <i>FHM10 and FHC50</i>	SETB HIVEL ALARM	The <b>SETB HIVEL ALARM</b> item sets the face velocity high alarm set point during Setback mode. A setback high velocity alarm condition is defined as when the face velocity exceeds the setback high velocity alarm set point during Setback mode.	OFF, 80 to 1000 ft/min	OFF
		<table border="1"> <tr> <td style="text-align: center;"><b>NOTE</b></td> </tr> <tr> <td>The <b>SETB HIVEL ALARM</b> must be at least 20 ft/min greater than the <b>SETBACK</b> set point.</td> </tr> </table>		
<b>NOTE</b>				
The <b>SETB HIVEL ALARM</b> must be at least 20 ft/min greater than the <b>SETBACK</b> set point.				

SETPOINTS MENU				
MENU ITEM	SOFTWARE NAME	ITEM DESCRIPTION	ITEM RANGE	DEFAULT VALUE
SETBACK LOW FLOW ALARM SETPOINT <i>FHM10 and FHC50</i>	SETB LOFLO ALARM	<p>The <b>SETB LOFLO ALARM</b> item sets the low flow alarm set point during <b>SETBACK</b>. A setback low flow alarm condition is defined as when the exhaust flow is less than the setback low flow alarm set point during <b>SETBACK</b>.</p> <p style="text-align: center;"><b>NOTE</b></p> <p>The <b>SETB LO FLOW ALARM</b> must be at least 50 cfm less than the <b>SETPOINT</b>.</p>	OFF, 0 to 10000 cfm	OFF
SETBACK HIGH FLOW ALARM SETPOINT <i>FHM10 and FHC50</i>	SETB HIFLO ALARM	<p>The <b>SETB HIFLO ALARM</b> item sets the high flow alarm set point during <b>SETBACK</b>. A setback high flow alarm condition is defined as when the exhaust flow is greater than the setback high flow alarm set point during <b>SETBACK</b>.</p> <p style="text-align: center;"><b>NOTE</b></p> <p>The <b>SETB HI FLOW ALARM</b> must be at least 50 cfm greater than the <b>SETPOINT</b>.</p>	OFF, 0 to 10000 cfm	OFF
HIGH SASH POSITION ALARM <i>FHC50 Only</i>	HI SASH POS ALARM 	<p>The <b>HI SASH POS ALARM</b> item is used to set the position of the high sash alarm. <b>INPUT SEL 1</b>, must be set to <b>SASH POS VERT</b> before setting this item.</p> <p style="text-align: center;"><b>NOTE</b></p> <p>The Sash Position Potentiometer must be calibrated before using this menu item.</p>	OFF, 10 to 105%	OFF
DAMPER ALARM <i>FHC50 Only</i>	DAMPER ALARM	<p>The <b>DAMPER ALARM</b> item sets the damper opening alarm setpoint for both Normal and Setback modes. If the Model FHC50 controller opens the damper more than the <b>DAMPER ALARM</b> setpoint, it will activate Relay B.</p> <p style="text-align: center;"><b>NOTE</b></p> <p>Relay B must be configured to <b>DAMPER OPEN</b> for the <b>DAMPER ALARM</b> to be active. <b>DAMPER ALARM</b> activates Relay B. <b>DAMPER ALARM</b> does not activate audible or visual alarms.</p>	OFF, 0 to 100% OPEN	100% OPEN

## SETPOINT/ALARM CONSTRAINTS

There are a number of constraints that prohibit you from incorrectly adjusting the set points. These are as follows:



1. The control **SETPOINT** and **SETBACK** set point have a lower limit of 60 ft/min. This is because generally accepted lab practices indicate that fume hood containment is lost below this face velocity.
2. The controller has been designed so that the **LOW ALARM** set point must be set at least 20 ft/min below the control **SETPOINT** when the FHC50 is set for face velocity control and 50 cfm when the FHC50 is set for flow control. For example, if the control **SETPOINT** is 100 ft/min, the **LOW ALARM** set point cannot be greater than 80 ft/min. This prevents nuisance alarms from occurring during natural system fluctuations.
3. The controller has been designed so that the **HIGH ALARM** set point must be set at least 20 ft/min above the control **SETPOINT** when the FHC50 is set for face velocity control and 50 cfm when the FHC50 is set for flow control. For example, if the control **SETPOINT** is 100 ft/min, the **HIGH ALARM** set point cannot be less than 120 ft/min. This prevents nuisance alarms from occurring during natural system fluctuations.
4. The monitor has been designed so that the **LOW ALARM** set point must be at least 40 fpm below the **HIGH ALARM** set point when the FHM10 is set for face velocity control and 100 cfm below the **HIGH ALARM** set point when the FHM10 is set for flow control.
5. The **ALARM RESET** item selects how the alarms will terminate when controller returns to the safe range. The face velocity alarms all terminate the same; they are either **LATCHED** or **UNLATCHED**. If **UNLATCHED** is selected, the low alarm automatically turns off when the face velocity exceeds the low face velocity alarm value by 20 ft/min or the low flow alarm value by 50 cfm. Conversely, the high alarm automatically turns off when the face velocity drops 20 ft/min below the high face velocity alarm set point or 50 cfm below the high flow alarm set point. If **LATCHED** is selected, the alarms will not terminate until the **RESET** key is pressed.

INTERFACE MENU				
MENU ITEM	SOFTWARE NAME	ITEM DESCRIPTION	ITEM RANGE	DEFAULT VALUE
NETWORK PROTOCOL <i>FHM10 and FHC50</i>	NET PROTOCOL	The <b>NET PROTOCOL</b> item selects the communications protocol used to interface with the building management system.	Modbus® N2 LonWorks®* BACnet®*	MODBUS
NETWORK ADDRESS AND SETTINGS <i>FHM10 and FHC50</i>	NETWORK SETTINGS	The <b>NETWORK SETTINGS</b> item enters a sub-menu with settings, such as network address, that are configured for each protocol.		

NETWORK SETTINGS SUBMENU				
PROTOCOL	SOFTWARE NAME	ITEM DESCRIPTION	ITEM RANGE	DEFAULT VALUE
Modbus®, N2 <i>FHM10 and FHC50</i>	NETWORK ADDRESS	The <b>NETWORK ADDRESS</b> item sets the main network address of the fume hood controller. Each unit on the network must have its own unique address.	1 to 247	1
Modbus® <i>FHM10 and FHC50</i>	# STOP BITS	The <b># STOP BITS</b> item sets the number of stop bits used in the Modbus stop communication	1 OR 2	2
BACnet® <i>FHM10 and FHC50</i>	MAC ADDRESS	The <b>MAC ADDRESS</b> item sets the main network address of the fume hood controller. Each unit on the network must have its own unique address.	1 to 127	1
BACnet® <i>FHM10 and FHC50</i>	MAC ID	The <b>MAC ID</b> item sets the Device ID.	1 to 4,194,302	100
BACnet® <i>FHM10 and FHC50</i>	AUTO BAUD	When the <b>AUTO BAUD</b> item is selected, the FHC50 will automatically set its baud rate for BACnet MS/TP communications.		
LON <i>FHM10 and FHC50</i>	SERVICE PIN	When the <b>SERVICE PIN</b> option is selected, the Model FHC50 sends a broadcast message containing its Neuron ID and program ID. This is required to install the Model FHC50 on the LonWorks® network, or to reinstall the Model FHC50 after using the <b>GO UNCONFIGURED</b> command.		



NETWORK SETTINGS SUBMENU				
PROTOCOL	SOFTWARE NAME	ITEM DESCRIPTION	ITEM RANGE	DEFAULT VALUE
LON <i>FHM10 and FHC50</i>	GO UNCONFIGURED	Selecting the <b>GO UNCONFIGURED</b> option resets the Model FHC50 controller's authentication key. This is required in the event a foreign network tool inadvertently acquires a Model FHC50 and installs it with network management authentication. The Model FHC50 controller's owner will then be unable to reclaim the Model FHC50 over the network.		

CALIBRATION MENU				
MENU ITEM	SOFTWARE NAME	ITEM DESCRIPTION	ITEM RANGE	DEFAULT VALUE
VELOCITY SENSOR ZERO  <i>FHM10 and FHC50</i>	VEL SENSOR ZERO  	<p>The <b>VEL SENSOR ZERO</b> item is used to calibrate the Sidewall velocity sensor at zero flow.</p> <p>A sensor zero should be established prior to adjusting the sensor span (see <a href="#">Calibration</a> section following menu item listing).</p> <p style="text-align: center;"><b>NOTE</b></p> <p>The menu item <b>VEL SENSOR</b> under the <b>CONFIGURE</b> menu must be set to <b>ENABLED</b>, by choosing an appropriate setting in the <b>CONTROL WIZARD</b>, to activate the <b>VEL SENSOR ZERO</b> function.</p>	NONE	Unit needs to be calibrated upon initial installation
VEL SENSOR SPAN  <i>FHM10 and FHC50</i>	VEL SENSOR SPAN  	<p>The <b>VEL SENSOR SPAN</b> item is used to calibrate the Sidewall velocity sensor to match the fume hood average face velocity. The average face velocity is measured by traversing the fume hood face with a portable air velocity meter (see <a href="#">Calibration</a> section following menu item listing).</p> <p>A velocity sensor zero should be established prior to adjusting the velocity sensor span (see <a href="#">Calibration</a> section following menu item listing).</p> <p style="text-align: center;"><b>NOTE</b></p> <p>The menu item <b>VEL SENSOR</b> under the <b>CONFIGURE</b> menu must be set to <b>ENABLED</b>, by choosing an appropriate setting in the <b>CONTROL WIZARD</b>, to activate the <b>VEL SENSOR ZERO</b> function.</p>	NONE	Unit needs to be calibrated upon initial installation
CALIBRATE FLOW  <i>FHM10 and FHC50</i>	CALIBRATE FLOW  	<p>The <b>CALIBRATE FLOW</b> item is used to enter a <a href="#">CALIBRATE FLOW sub-menu</a> that is specific to the <b>FLOW DEVICE</b> that is selected (see <a href="#">Flow Calibrate</a> section following menu item listing).</p> <p style="text-align: center;"><b>NOTE</b></p> <p>The <b>CALIBRATE FLOW</b> menu item will not appear if the <b>FLOW DEVICE</b> under the <b>CONFIGURE</b> menu has been set to <b>NONE</b>.</p>	NONE	Unit needs to be calibrated upon initial installation

CALIBRATION MENU						
MENU ITEM	SOFTWARE NAME	ITEM DESCRIPTION	ITEM RANGE	DEFAULT VALUE		
BALANCE MODE <i>FHC50 Only</i>	BALANCE MODE  	<p>The <b>BALANCE MODE</b> item is used to enter a <b>BALANCE MODE</b> sub-menu. After a flow device has been calibrated, the <b>BALANCE MODE</b> screen can be used to compare the Measured Flow against the Actual Flow as determined by a pitot tube traverse.</p> <table border="1" data-bbox="695 431 1409 548"> <thead> <tr> <th>NOTE</th> </tr> </thead> <tbody> <tr> <td>The <b>CALIBRATE FLOW</b> submenu must be completed before entering the <b>BALANCE MODE</b> submenu.</td> </tr> </tbody> </table>	NOTE	The <b>CALIBRATE FLOW</b> submenu must be completed before entering the <b>BALANCE MODE</b> submenu.	NONE	N/A
NOTE						
The <b>CALIBRATE FLOW</b> submenu must be completed before entering the <b>BALANCE MODE</b> submenu.						
SASH CLOSED POSITION CALIBRATION <i>FHC50 Only</i>	SASH CAL CLOSED	<p>The <b>SASH CAL CLOSED</b> item is used to record sash position of the fume hood. This is determined in one of two ways:</p> <ol style="list-style-type: none"> <li>1. If a Vertical Sash Position Sensor is being used, this menu item will record the physical position of the Potentiometer with the sash closed.</li> <li>2. If there is no Vertical Sash Position sensor, the controller will use both the face velocity and flow information in the sash closed position to calibrate the sash % open equation.</li> </ol> <p>Upon entering this menu item, the display will read “<b>Lower Sash, then Press Enter.</b>” Make sure the sash is lowered completely, and then press the <b>Enter</b> key.</p> <p>This menu item will timeout after a period of one hour if the <b>Enter</b> key is not pressed. No information will be saved if timeout occurs.</p> <p>This menu item will not appear if the controller is not configured to accept a sash sensor or flow measurement with sidewall sensor.</p>	NONE	Unit needs to be calibrated upon initial installation		

<b>CALIBRATION MENU</b>				
<b>MENU ITEM</b>	<b>SOFTWARE NAME</b>	<b>ITEM DESCRIPTION</b>	<b>ITEM RANGE</b>	<b>DEFAULT VALUE</b>
SASH OPEN POSITION CALIBRATION <i>FHC50 Only</i>	SASH CAL OPEN	<p>The <b>SASH CAL OPEN</b> item is used to record sash position of the fume hood. This is determined in one of two ways:</p> <ol style="list-style-type: none"> <li>1. If a Vertical Sash Position Sensor is being used, this menu item will record the physical position of the Potentiometer with the sash open.</li> <li>2. If there is no Vertical Sash Position sensor, then the controller will use both the face velocity and flow information in the sash open position to calibrate the sash % open equation.</li> </ol> <p>Upon entering this menu item, the display will read “<b>Raise Sash, then Press Enter.</b>” Make sure the sash is raised, and then press the <b>Enter</b> key.</p> <p>This menu item will timeout after a period of one hour if the <b>Enter</b> key is not pressed. No information will be saved if timeout occurs.</p> <p>This menu item will not appear if the controller is not configured to accept a sash sensor or flow measurement with sidewall sensor.</p>	NONE	Unit needs to be calibrated upon initial installation

<b>CALIBRATE FLOW SUBMENU</b>				
PRESSURE FLOW STATION				
<b>MENU ITEM</b>	<b>SOFTWARE NAME</b>	<b>ITEM DESCRIPTION</b>	<b>ITEM RANGE</b>	<b>DEFAULT VALUE</b>
FLOW DEVICE SELECTED <i>FHM10 and FHC50</i>	FLOW DEVCE =	This item displays the <b>FLOW DEVICE</b> that was previously selected through the <b>CONFIG WIZARD</b> item.	Lin Flo Sta Press Flo Sta LOM Venturi 6pt Venturi Calculated	Press Flo Sta (Read-only value)

<b>CALIBRATE FLOW SUBMENU</b> PRESSURE FLOW STATION				
<b>MENU ITEM</b>	<b>SOFTWARE NAME</b>	<b>ITEM DESCRIPTION</b>	<b>ITEM RANGE</b>	<b>DEFAULT VALUE</b>
RESET FLOW CALIBRATION  <i>FHM10 and FHC50</i>	FLOW RESET CAL	The <b>RESET CAL</b> menu item zeroes out the flow calibration adjustments. When this menu item is entered, the controller will prompt the user to verify that they want to do this by displaying the message “ <b>Are You Sure.</b> ” Entering <b>YES</b> resets the flow calibration factors for this flow device to defaults and shows the message “ <b>Changes Saved.</b> ” Entering <b>NO</b> will cancel the reset and show the message “ <b>Changes Not Saved.</b> ”	NONE	
FLOW STATION DUCT AREA  <i>FHM10 and FHC50</i>	FLO STA AREA	The <b>FLO STA AREA</b> item is used to program the cross sectional area of the duct where the flow station is mounted. Since the flow station is used to measure duct velocity, the <b>FLO STA AREA</b> is necessary to calculate the duct air flow.  <div style="background-color: #0056b3; color: white; text-align: center; padding: 2px;"><b>NOTE</b></div> The DIM does not compute duct area. The area must be first calculated and then entered into the unit.  Use the following equations to calculate the duct area (in ft <sup>2</sup> ) For <b>round</b> ducts $\text{DUCT AREA} = \frac{3.14 * [\text{duct diameter (in inches)}]^2}{144}$ For <b>rectangular</b> ducts $\text{DUCT AREA} = \frac{[\text{width (in inches)} * \text{height (in inches)}]}{144}$  <div style="background-color: #ff9900; color: white; text-align: center; padding: 2px;"><b>WARNING</b></div>  If the proper <b>FLO STA AREA</b> is not programmed into the Model FHC50, the flow measurement will be incorrect. Thus, all the other information that uses the flow measurement, such as the flow alarms and percent sash open, will also be incorrect.	0 to 50.00 ft <sup>2</sup> (0 to 4.6450 m <sup>2</sup> )	0.00 ft <sup>2</sup> (0.0000 m <sup>2</sup> )

<b>CALIBRATE FLOW SUBMENU</b>				
PRESSURE FLOW STATION				
<b>MENU ITEM</b>	<b>SOFTWARE NAME</b>	<b>ITEM DESCRIPTION</b>	<b>ITEM RANGE</b>	<b>DEFAULT VALUE</b>
FLOW STATION PRESSURE FULL SCALE <i>FHM10 and FHC50</i>	FLO STA PRESS FS	The <b>FLO STA PRESS FS</b> menu item allows the user to select the maximum range of the pressure transducer used with the flow station.	0.10 inH <sub>2</sub> O 0.25 inH <sub>2</sub> O 0.50 inH <sub>2</sub> O 1.0 inH <sub>2</sub> O	1.0 inH <sub>2</sub> O
FLOW STATION PRESSURE ZERO <i>FHM10 and FHC50</i>	FLO STA PRESS ZERO	The <b>FLO STA PRESS ZERO</b> item is used to calibrate the zero in the pressure transducer. See <a href="#">Calibration</a> section for the procedure to zero the flow station.	NONE	
FLOW STATION OUTPUT RANGE <i>FHM10 and FHC50</i>	FLO STA FS V	The <b>FLO STA FS V</b> item is used to set the voltage signal output range of the pressure transducer. Set this item to match the pressure transducer used.  <b>NOTE</b> If a pressure transducer with a 1-5 V output is used, select 0 to 5V. If a pressure transducer with a 2-10 V output is used, select 0 to 10V.	0 to 5V, 0 to 10V	0 to 10V
FLOW STATION LOW CAL <i>FHM10 and FHC50</i>	FLO STA LO CAL	The <b>FLO STA LO CAL</b> menu item enters the <b>FLO STA LO CAL</b> Submenu.	See <a href="#">FLO STA LO CAL</a> Menu	
FLOW STATION HIGH CAL <i>FHM10 and FHC50</i>	FLO STA HI CAL	The <b>FLO STA HI CAL</b> menu item enters the <b>FLO STA HI CAL</b> Submenu.	See <a href="#">FLO STA HI CAL</a> Menu	
FLOW K FACTOR <i>FHM10 and FHC50</i>	FLOW KFACTOR	The <b>K FACTOR</b> menu item sets the “K” factor for the flow signal. The flow signal is multiplied by the <b>K FACTOR</b> so that the flow measurement matches the actual flow, determined with a pitot tube traverse.  <b>NOTE</b> <b>FLOW K FACTOR</b> modifies the entire range of the calibrated flow, not just a single point.	0.01 to 10.00	1.00



<b>CALIBRATE FLOW SUBMENU</b>						
LINEAR FLOW STATION ONLY						
<b>MENU ITEM</b>	<b>SOFTWARE NAME</b>	<b>ITEM DESCRIPTION</b>	<b>ITEM RANGE</b>	<b>DEFAULT VALUE</b>		
FLOW DEVICE SELECTED  <i>FHM10 and FHC50</i>	FLOW DEVCE =	This item displays the <b>FLOW DEVICE</b> that was previously selected through the <b>CONFIG WIZARD</b> item.	Lin Flo Sta Press Flo Sta LOM Venturi 6pt Venturi Calculated	Lin Flo Sta  (Read-only value)		
RESET FLOW CALIBRATION  <i>FHM10 and FHC50</i>	FLOW RESET CAL	The <b>RESET CAL</b> menu item zeroes out the flow calibration adjustments. When this menu item is entered, the controller will prompt the user to verify that they want to do this by displaying the message “ <b>Are You Sure.</b> ” Entering <b>YES</b> resets the flow calibration factors for this flow device to defaults and shows the message “ <b>Changes Saved.</b> ” Entering <b>NO</b> will cancel the reset.	NONE			
FLOW STATION DUCT AREA  <i>FHM10 and FHC50</i>	FLO STA AREA	The <b>FLO STA AREA</b> item is used to program the cross sectional area of the duct where the flow station is mounted. Since the flow station is used to measure duct velocity, the <b>FLO STA AREA</b> is necessary to calculate the duct air flow. <table border="1" style="width: 100%; margin-top: 10px;"> <thead> <tr> <th style="background-color: #0056b3; color: white;">NOTE</th> </tr> </thead> <tbody> <tr> <td>The DIM does not compute duct area. The area must be first calculated and then entered into the unit.</td> </tr> </tbody> </table> <p>Use the following equations to calculate the duct area (in ft<sup>2</sup>)</p> <p>For <b>round</b> ducts</p> $\text{DUCT AREA} = \frac{3.14 * [\text{duct diameter (in inches)} / 2]^2}{144}$ <p>For <b>rectangular</b> ducts</p> $\text{DUCT AREA} = \frac{[\text{width (in inches)} * \text{height (in inches)}]}{144}$	NOTE	The DIM does not compute duct area. The area must be first calculated and then entered into the unit.	0 to50.00 ft <sup>2</sup> (0 to 4.6450 m <sup>2</sup> )	0.00 ft <sup>2</sup> (0.0000 m <sup>2</sup> )
NOTE						
The DIM does not compute duct area. The area must be first calculated and then entered into the unit.						



CALIBRATE FLOW SUBMENU				
LINEAR FLOW STATION ONLY				
MENU ITEM	SOFTWARE NAME	ITEM DESCRIPTION	ITEM RANGE	DEFAULT VALUE
FLOW STATION DUCT AREA  <i>FHM10 and FHC50 (cont.)</i>	FLO STA AREA <i>(cont.)</i>  	<div style="background-color: #FFA500; text-align: center; padding: 2px;"><b>WARNING</b></div> <p>If the proper <b>FLO STA AREA</b> is not programmed into the Model FHC50, the flow measurement will be incorrect. Thus, all the other information that uses the flow measurement, such as the flow alarms and percent sash open, will also be incorrect.</p>		
FLOW STATION TOP VELOCITY  <i>FHM10 and FHC50</i>	FLO STA TOP VEL	The <b>TOP VELOCITY</b> item is used to input the maximum velocity of a linear flow station output. A <b>TOP VELOCITY</b> must be input for the linear flow station to operate.	0 to 10,000 ft/min (0 to 50.8 m/s)	0 ft/min (0 m/s)
FLOW STATION OUTPUT RANGE  <i>FHM10 and FHC50</i>	FLO STA FS V	The <b>FLO STA FS V</b> item is used to set the voltage signal output range of the pressure transducer. Set this item to match the pressure transducer used.	0 to 5V, 0 to 10V	0 to 10V
FLOW K FACTOR  <i>FHM10 and FHC50</i>	FLOW KFACTOR	<p>The <b>K FACTOR</b> menu item sets the “K” factor for the flow signal. The flow signal is multiplied by the <b>K FACTOR</b> so that the flow measurement matches the actual flow, determined with a pitot tube traverse.</p> <div style="background-color: #0070C0; color: white; text-align: center; padding: 2px;"><b>NOTE</b></div> <p><b>FLOW K FACTOR</b> modifies the entire range of the calibrated flow, not just a single point.</p>	0.01 to 10.00	1.00



CALIBRATE FLOW SUBMENU				
LOM VENTURI VALVE ONLY				
MENU ITEM	SOFTWARE NAME	ITEM DESCRIPTION	ITEM RANGE	DEFAULT VALUE
FLOW DEVICE SELECTED  <i>FHM10 and FHC50</i>	FLOW DEVCE =	This item displays the <b>FLOW DEVICE</b> that was previously selected through the <b>CONFIG WIZARD</b> item.	Lin Flo Sta Press Flo Sta LOM Venturi 6pt Venturi Calculated	LOM Venturi (Read-only value)





<b>CALIBRATE FLOW SUBMENU</b> LOM VENTURI VALVE ONLY				
<b>MENU ITEM</b>	<b>SOFTWARE NAME</b>	<b>ITEM DESCRIPTION</b>	<b>ITEM RANGE</b>	<b>DEFAULT VALUE</b>
RESET FLOW CALIBRATION  <i>FHM10 and FHC50</i>	FLOW RESET CAL          	The <b>RESET CAL</b> menu item zeroes out the flow calibration adjustments. When this menu item is entered, the controller will prompt the user to verify that they want to do this by displaying the message “ <b>Are You Sure.</b> ” Entering <b>YES</b> resets the flow calibration factors for this flow device to defaults and shows the message “ <b>Changes Saved.</b> ” Entering <b>NO</b> will cancel the reset and show the message “ <b>Changes Not Saved.</b> ”  <div style="background-color: #FFA500; text-align: center; padding: 2px;"><b>WARNING</b></div> Monitor and/or controller alarm functions will not be maintained after resetting flow calibration. Immediately recalibrate monitor or controller after resetting flow calibration.	NONE	
MINIMUM FLOW  <i>FHM10 and FHC50</i>	VENTURI LF MIN FLOW	The <b>VENTURI LF MIN FLOW</b> item sets the flow rate through the venturi valve when it is fully closed. The display will indicate a volumetric flow rate. Adjust the displayed value to match the flow through the venturi valve.  <div style="background-color: #0056B3; color: white; text-align: center; padding: 2px;"><b>NOTE</b></div> The flow information can be obtained from the label on the TSI® Venturi Valve or by closing the venturi valve using the <b>CONTROL OUT</b> item in the <b>DIAGNOSTICS</b> menu and performing a pitot tube traverse of the duct.  The <b>VENTURI LF MIN FLOW</b> menu item must be completed before moving on to the <b>VENTURI LF MAX FLOW</b> menu item.	0 to 10000 cfm	0 cfm

<b>CALIBRATE FLOW SUBMENU</b>				
LOM VENTURI VALVE ONLY				
<b>MENU ITEM</b>	<b>SOFTWARE NAME</b>	<b>ITEM DESCRIPTION</b>	<b>ITEM RANGE</b>	<b>DEFAULT VALUE</b>
MAXIMUM FLOW <i>FHM10 and FHC50</i>	VENTURI LF MAX FLOW	<p>The <b>VENTURI LF MAX FLOW</b> item sets the flow rate through the venturi valve when it is fully open. The display will indicate a volumetric flow rate. Adjust the displayed value to match the flow through the venturi valve.</p> <div style="border: 1px solid black; padding: 5px; margin: 5px 0;"> <p style="text-align: center;"><b>NOTE</b></p> <p>The flow information can be obtained from the label on the TSI® Venturi Valve or by opening the venturi valve using the <b>CONTROL OUT</b> item in the <a href="#">DIAGNOSTICS</a> menu and performing a pitot tube traverse of the duct.</p> </div> <p>The <b>VENTURI LF MIN FLOW</b> menu item must be completed before moving on to the <b>VENTURI LF MAX FLOW</b> menu item.</p>	0 to 10000 cfm	0 cfm
FLOW K FACTOR <i>FHM10 and FHC50</i>	FLOW KFACTOR	<p>The <b>K FACTOR</b> menu item sets the “K” factor for the flow signal. The flow signal is multiplied by the <b>K FACTOR</b> so that the flow measurement matches the actual flow, determined with a pitot tube traverse.</p> <div style="border: 1px solid black; padding: 5px; margin: 5px 0;"> <p style="text-align: center;"><b>NOTE</b></p> <p><b>FLOW K FACTOR</b> modifies the entire range of the calibrated flow, not just a single point.</p> </div>	0.01 to 10.00	1.00

<b>CALIBRATE FLOW SUBMENU</b>				
6PT VENTURI VALVE ONLY				
<b>MENU ITEM</b>	<b>SOFTWARE NAME</b>	<b>ITEM DESCRIPTION</b>	<b>ITEM RANGE</b>	<b>DEFAULT VALUE</b>
FLOW DEVICE SELECTED <i>FHC50 Only</i>	FLOW DEVCE =	This item displays the <b>FLOW DEVICE</b> that was previously selected through the <b>CONFIG WIZARD</b> item.	Lin Flo Sta Press Flo Sta LOM Venturi 6pt Venturi Calculated	6Pt Venturi (Read-only value)
RESET FLOW CALIBRATION <i>FHC50 Only</i>	FLOW RESET CAL	The <b>RESET CAL</b> menu item zeroes out the flow calibration adjustments. When this menu item is entered, the controller will prompt the user to verify that they want to do this by displaying the message “ <b>Are You Sure.</b> ” Entering <b>YES</b> resets the flow calibration factors for this flow device to defaults and shows the message “ <b>Changes Saved.</b> ” Entering <b>NO</b> will cancel the reset and show the message “ <b>Changes Not Saved.</b> ”	NONE	
		<div style="background-color: #FFA500; text-align: center; padding: 2px;"><b>WARNING</b></div> Controller alarm functions will not be maintained after resetting flow calibration. Immediately recalibrate controller after resetting flow calibration.		
VENTURI VALVE POSITION 1 FLOW <i>FHC50 Only</i>	VENTURI PT1	The <b>VENTURI PT1</b> item is used to calibrate a venturi valve without feedback. When this item is entered, the display will indicate a volumetric flow rate. Adjust the displayed value to match the flow through the venturi valve when the venturi valve is at the <b>0% OPEN</b> position.	0 to 10000 cfm	0 cfm
		<div style="background-color: #0070C0; color: white; text-align: center; padding: 2px;"><b>NOTE</b></div> The flow information can be obtained through a direct flow measurement (i.e. duct traverse) after using the <a href="#">CONTROL OUT</a> item to set the damper to 0% Open or from the label on the TSI® Venturi Valve.		
		The <b>VENTURI PT1</b> menu item must be completed before moving on to the <b>VENTURI PT2</b> menu item.		

<b>CALIBRATE FLOW SUBMENU</b>				
6PT VENTURI VALVE ONLY				
<b>MENU ITEM</b>	<b>SOFTWARE NAME</b>	<b>ITEM DESCRIPTION</b>	<b>ITEM RANGE</b>	<b>DEFAULT VALUE</b>
VENTURI VALVE POSITION 2 FLOW <i>FHC50 Only</i>	VENTURI PT2  	<p>The <b>VENTURI PT2</b> item is used to calibrate a venturi valve without feedback. When this item is entered, the display will indicate a volumetric flow rate. Adjust the displayed value to match the flow through the venturi valve when the venturi valve is at the <b>20% OPEN</b> position.</p> <div style="border: 1px solid black; background-color: #0070C0; color: white; text-align: center; padding: 2px;"><b>NOTE</b></div> <p>The flow information can be obtained through a direct flow measurement (i.e. duct traverse) after using the <a href="#">CONTROL OUT</a> item to set the damper to 20% Open or from the label on the TSI® Venturi Valve.</p> <p>The <b>VENTURI PT2</b> menu item must be completed before moving on to the <b>VENTURI PT3</b> menu item.</p>	0 to 10000 cfm	0 cfm
VENTURI VALVE POSITION 3 FLOW <i>FHC50 Only</i>	VENTURI PT3  	<p>The <b>VENTURI PT3</b> item is used to calibrate a venturi valve without feedback. When this item is entered, the display will indicate a volumetric flow rate. Adjust the displayed value to match the flow through the venturi valve when the venturi valve is at the <b>40% OPEN</b> position.</p> <div style="border: 1px solid black; background-color: #0070C0; color: white; text-align: center; padding: 2px;"><b>NOTE</b></div> <p>The flow information can be obtained through a direct flow measurement (i.e. duct traverse) after using the <a href="#">CONTROL OUT</a> item to set the damper to 40% Open or from the label on the TSI® Venturi Valve.</p> <p>The <b>VENTURI PT3</b> menu item must be completed before moving on to the <b>VENTURI PT4</b> menu item.</p>	0 to 10000 cfm	0 cfm

<b>CALIBRATE FLOW SUBMENU</b> 6PT VENTURI VALVE ONLY				
<b>MENU ITEM</b>	<b>SOFTWARE NAME</b>	<b>ITEM DESCRIPTION</b>	<b>ITEM RANGE</b>	<b>DEFAULT VALUE</b>
VENTURI VALVE POSITION 4 FLOW  <i>FHC50 Only</i>	VENTURI PT4  	The <b>VENTURI PT4</b> item is used to calibrate a venturi valve without feedback. When this item is entered, the display will indicate a volumetric flow rate. Adjust the displayed value to match the flow through the venturi valve when the venturi valve is at the <b>60% OPEN</b> position.  <div style="border: 1px solid black; padding: 5px; margin: 5px 0;"> <p style="text-align: center; background-color: #0070C0; color: white; margin: 0;"><b>NOTE</b></p> <p>The flow information can be obtained through a direct flow measurement (i.e. duct traverse) after using the <a href="#">CONTROL OUT</a> item to set the damper to 60% Open or from the label on the TSI® Venturi Valve.</p> </div> The <b>VENTURI PT4</b> menu item must be completed before moving on to the <b>VENTURI PT5</b> menu item.	0 to 10000 cfm	0 cfm
VENTURI VALVE POSITION 5 FLOW  <i>FHC50 Only</i>	VENTURI PT5  	The <b>VENTURI PT5</b> item is used to calibrate a venturi valve without feedback. When this item is entered, the display will indicate a volumetric flow rate. Adjust the displayed value to match the flow through the venturi valve when the venturi valve is at the <b>80% OPEN</b> position.  <div style="border: 1px solid black; padding: 5px; margin: 5px 0;"> <p style="text-align: center; background-color: #0070C0; color: white; margin: 0;"><b>NOTE</b></p> <p>The flow information can be obtained through a direct flow measurement (i.e. duct traverse) after using the <a href="#">CONTROL OUT</a> item to set the damper to 80% Open or from the label on the TSI® Venturi Valve.</p> </div> The <b>VENTURI PT5</b> menu item must be completed before moving on to the <b>VENTURI PT6</b> menu item.	0 to 10000 cfm	0 cfm

CALIBRATE FLOW SUBMENU				
6PT VENTURI VALVE ONLY				
MENU ITEM	SOFTWARE NAME	ITEM DESCRIPTION	ITEM RANGE	DEFAULT VALUE
VENTURI VALVE POSITION 6 FLOW <i>FHC50 Only</i>	VENTURI PT6  	The <b>VENTURI PT6</b> item is used to calibrate a venturi valve without feedback. When this item is entered, the display will indicate a volumetric flow rate. Adjust the displayed value to match the flow through the venturi valve when the venturi valve is at the <b>100% OPEN</b> position.  <b>NOTE</b> The flow information can be obtained through a direct flow measurement (i.e., duct traverse) after using the <a href="#">CONTROL OUT</a> item to set the damper to 100% Open or from the label on the TSI® Venturi Valve.	0 to 10000 cfm	0 cfm
FLOW K FACTOR <i>FHC50 Only</i>	FLOW KFACTOR	The <b>K FACTOR</b> menu item sets the “ <b>K</b> ” factor for the flow signal. The flow signal is multiplied by the <b>K FACTOR</b> so that the flow measurement matches the actual flow, determined with a pitot tube traverse.  <b>NOTE</b> <b>FLOW K FACTOR</b> modifies the entire range of the calibrated flow, not just a single point.	0.01 to 10.00	1.00

CALIBRATE FLOW SUBMENU				
CALCULATED FLOW ONLY				
MENU ITEM	SOFTWARE NAME	ITEM DESCRIPTION	ITEM RANGE	DEFAULT VALUE
FLOW DEVICE SELECTED <i>FHC50 Only</i>	FLOW DEVCE =	This item displays the <b>FLOW DEVICE</b> that was previously selected through the <b>CONFIG WIZARD</b> item.	Lin Flo Sta Press Flo Sta LOM Venturi 6pt Venturi Calculated	Calculated (Read-only value)

CALIBRATE FLOW SUBMENU				
CALCULATED FLOW ONLY				
MENU ITEM	SOFTWARE NAME	ITEM DESCRIPTION	ITEM RANGE	DEFAULT VALUE
RESET FLOW CALIBRATION <i>FHC50 Only</i>	FLOW RESET CAL  	The <b>RESET CAL</b> menu item zeroes out the flow calibration adjustments. When this menu item is entered, the controller will prompt the user to verify that they want to do this by displaying the message “ <b>Are You Sure.</b> ” Entering <b>YES</b> resets the flow calibration factors for this flow device to defaults and shows the message “ <b>Changes Saved.</b> ” Entering <b>NO</b> will cancel the reset and show the message “ <b>Changes Not Saved.</b> ”  <div style="background-color: #FFA500; text-align: center; padding: 2px;"><b>WARNING</b></div> Controller alarm functions will not be maintained after resetting flow calibration. Immediately recalibrate controller after resetting flow calibration.	NONE	
FLOW K FACTOR <i>FHC50 Only</i>	FLOW KFACTOR	The <b>K FACTOR</b> menu item sets the “K” factor for the flow signal. The flow signal is multiplied by the <b>K FACTOR</b> so that the flow measurement matches the actual flow, determined with a pitot tube traverse.  <div style="background-color: #0070C0; color: white; text-align: center; padding: 2px;"><b>NOTE</b></div> <b>FLOW K FACTOR</b> modifies the entire range of the calibrated flow, not just a single point.	0.01 to 10.00	1.00

<b>BALANCE MODE SUBMENU</b>				
<b>MENU ITEM</b>	<b>SOFTWARE NAME</b>	<b>ITEM DESCRIPTION</b>	<b>ITEM RANGE</b>	<b>DEFAULT VALUE</b>
DESIRED FLOW <i>FHC50 Only</i>	DESIRED FLOW	The <b>DESIRED FLOW</b> item is used to set and hold the controller at a desired flow to enable a balancing technician to verify flow through the fume hood.	0 to 10000 cfm	0
BALANCE MODE K FACTOR <i>FHC50 Only</i>	FLOW KFACTOR	<p>The <b>FLOW KFACTOR</b> item is used to adjust the measured flow to match the actual flow measured by the balancing technician.</p> <div style="border: 1px solid black; padding: 5px; margin: 5px 0;"> <p style="text-align: center; background-color: #0056b3; color: white; margin: 0;"><b>NOTE</b></p> <p>Changing the <b>FLOW KFACTOR</b> item also adjusts the <b>FLOW KFACTOR</b> item stored under the <b>CALIBRATE FLOW</b> submenu.</p> </div>	0.01 to 10.00	1.00
UNCORRECTED FLOW <i>FHC50 Only</i>	UNCORRECTED FLOW	The <b>UNCORRECTED FLOW</b> item displays the measured flow without applying a K Factor. This item is for reference only.	0 to 10000 cfm	NONE (Read-only value)
K FACTOR USED <i>FHC50 Only</i>	KF USED	The <b>KF USED</b> item is used to display the K Factor currently being used to adjust the flow. This value is for reference only, and will update when <b>BAL MODE Kf</b> is adjusted.	0.01 to 10.00	NONE (Read-only value)
CORRECTED FLOW <i>FHC50 Only</i>	FLOW * Kf	The <b>FLOW*Kf</b> item is used to display the corrected flow, which multiplies the uncorrected flow by the K Factor currently being used. This value is for reference only, and will update when <b>BAL MODE Kf</b> is adjusted.	0 to 10000 cfm	NONE (Read-only value)



CONTROL MENU				
MENU ITEM	SOFTWARE NAME	ITEM DESCRIPTION	ITEM RANGE	DEFAULT VALUE
<b>SENSITIVITY</b> <i>FHC50 Only</i>	<b>SENSITIVITY</b>	<p>The <b>SENSITIVITY</b> item selects the integral dead band. The integral dead band determines when the controller uses integral control (slow control), and when the controller enters PID control (fast control).</p> <p>Each % of <b>SENSITIVITY</b> represents 1 ft/min (5 cfm) that the face velocity (flow rate) must be away from set point before the FHC50 controller enters PID control (fast control). For example, if the <b>SENSITIVITY</b> is set to 80% and the set point is 100 fpm (500 cfm), the face velocity must drop below 80 fpm (400 cfm) or rise above 120 fpm (600 cfm) for the controller to enter PID control.</p> <div style="border: 1px solid black; background-color: #FFA500; padding: 2px; text-align: center; margin: 5px 0;"><b>WARNING</b></div> <p>Controller may hunt if <b>SENSITIVITY</b> is set too high, resulting in poor control and loss of containment.</p>	10% to 100%	80%
<b>SPEED</b> <i>FHC50 Only</i>	<b>SPEED</b>	<p>The <b>SPEED</b> item selects the control output speed. The greater the <b>SPEED</b> setting, the faster the control output.</p>	10% to 100%	80%
<b>CONTROL SIGNAL</b> <i>FHC50 Only</i>	<b>CONTROL SIG</b>	<p>The <b>CONTROL SIG</b> item determines the control signal's output direction. As an example: if the control system closes the exhaust damper instead of opening the damper, this option will reverse the control signal to now open the damper.</p>	DIRECT OR REVERSE	DIRECT

CONTROL MENU				
MENU ITEM	SOFTWARE NAME	ITEM DESCRIPTION	ITEM RANGE	DEFAULT VALUE
Kc VALUE Ti VALUE  <i>FHC50 Only</i>	Kc VALUE Ti VALUE	<p>The <b>Kc VALUE</b> item changes the gain control coefficient. When this item is entered, a value for Kc is indicated on the display. If the controller is not controlling correctly (hunting, oscillating, or controlling slowly) the <b>Kc VALUE</b> control coefficient may need adjusting. Decreasing Kc will slow the control system down making it more stable.</p> <p>The <b>Ti VALUE</b> item changes the integral control coefficient. When this item is entered, a value for Ti is indicated on the display. If the controller is not controlling correctly, the unit may have an inappropriate <b>Ti VALUE</b> control coefficient. Increasing Ti will slow the control system down making it more stable.</p> <div style="border: 1px solid black; background-color: #FFA500; text-align: center; padding: 5px;"><b>WARNING</b></div> <p>The <b>Kc VALUE</b> and <b>Ti VALUE</b> items provide you with the ability to manually change the PI control loop variables. <b>DO NOT CHANGE THESE VALUES UNLESS YOU HAVE A THOROUGH UNDERSTANDING OF PID CONTROL LOOPS. CONTACT TSI® FOR ASSISTANCE PRIOR TO CHANGING ANY VALUES.</b> Incorrectly changing a value will result in poor or non-existent control.</p> <p><b>Suggestion:</b> Before changing Kc or Ti, change the <b>SPEED</b> or adjust the <b>SENSITIVITY</b> to try to eliminate the problem.</p>	Kc = 0 to 1000 Ti = 0-1000  The range of values is very large. Poor control may occur if values are more than twice or less than 1/2 the default value	Kc = 100 Ti = 110



---

## Calibration

The calibration section explains how to calibrate the controller and how to zero a TSI® flow station pressure transducer (optional). The Fume Hood Monitor or Controller must be calibrated, after being installed on the fume hood, to provide accurate indication of fume hood face velocity and/or exhaust flow. The FHM10 Monitor and FHC50 Controller will warn the user with a display message if it has not been calibrated.

### NOTE

This section assumes that the appropriate sensor has been correctly installed. Inaccurate readings may be detected if sensor is not installed correctly. Review the Installation Instructions and verify that the sensor is installed correctly (usually only a problem on initial set up).

The following items are needed to calibrate a Model FHM10 Fume Hood Monitor or Model FHC50 Fume Hood Controller:

- Masking tape
- Tape measure
- Portable Air Velocity Meter such as TSI® VelociCalc® Model 9545 or Model 9515.



### WARNING

The controller is disabled during calibration. Containment may not be maintained.

To begin the calibration process, enter **CALIBRATION** menu (see [Software Programming](#) if not familiar with keystroke procedure).

## Face Velocity Calibration

Face velocity can be controlled using either a sidewall sensor or sash-position sensor with a venturi valve.

### Sidewall Velocity Sensor—Sensor Zero

1. Select **VEL SENSOR ZERO** item.
2. The controller will prompt to “**Tape over sensor, then press ↵.**” Place a piece of tape over the velocity sensor opening to seal off air flowing past the sensor and press the ↵ soft key.
3. The display will indicate a countdown for the automatic sensor zero procedure, which takes 120 seconds. While counting down the 120 seconds, the controller will also display the current sensor voltage.
4. After the 120 second countdown, the controller will display “**Remove tape from sensor, then press ↵.**” Remove tape from sensor and press the ↵ key to save the zero point.

### Sidewall Velocity Sensor—Sensor Span



### NOTE

Always zero sensor prior to adjusting the sensor span. A comparison thermal anemometer is required to calibrate the velocity span. Confirm a good average face velocity is present in the fume face before adjusting the span.

1. Open the fume hood sash 60% (or to working height) and let the controller reach face velocity set point.
2. Select **VEL SENSOR SPAN** item (30 second countdown). After the countdown, the **VEL SENSOR SPAN** submenu will be displayed.
3. Use a thermal anemometer to traverse the open sash area and obtain the average face velocity of the air passing into the hood.
4. Compare the thermal anemometer reading to the **SPANNED VEL** reading on the controller.
5. At the **ENTER SPAN FACT** menu item, press the quick keys to adjust the factor until the **SPANNED VEL** reading on the controller display matches the thermal anemometer velocity.
6. Press the **ENTER (↵)** soft key to save the sensor span calibration.

NOTE
To verify proper calibration, re-enter <b>VEL SENSOR SPAN</b> item and compare <b>SPANNED VEL</b> reading to a new thermal anemometer traverse.

7. Exit menu, sidewall sensor calibration is complete.

WARNING	
	Calibrating the sidewall velocity span on the controller may be an iterative process that takes 1 to 3 trials to get an accurate calibration. After adjusting the span factor, check the calibration to verify an accurate calibration.

## Sash Position Calibration

1. Calibrate flow using [LOM VENTURI](#) Calibration section.
2. Calibrate vertical sash sensor using [CALIBRATE SASH POT](#) section.
3. Enter **SASH FLOW CONTROL** item.
4. Controller will prompt “**Raise sash to 24 inches height then press ↵.**” Open the sash(es) to the 24-inch height and press the ↵ key.
  - a. The FHC50 controller will display the following items:

<b>Desired Flow</b>	Flow set point to achieve desired face velocity
<b>Show Sash % Open</b>	Readout of current sash % open
<b>Actual Flow</b>	Readout of current measured flow
<b>Save &amp; Continue</b>	Use to save data point
<b>Set flow for</b>	Desired face velocity

- b. Perform a face velocity traverse using a thermal anemometer. Compare the face velocity traverse reading to the face velocity set point.
- c. Adjust the Desired Flow to change the flow control set point for the 24-inch sash position until actual face velocity matches the Set flow for set point.
- d. Repeat steps b. and c. as needed before selecting **Save & Continue** to save the high sash position calibration.

5. Controller will prompt “**Lower sash to 12 inches height then press ↵.**” Lower the sash(es) to the 12-inch height, so the fume hood bypass (if present) is just covered, and press the ↵ key.

- a. The FHC50 controller will display the following items:

<b>Desired Flow</b>	Flow set point to achieve desired face velocity
<b>Show Sash % Open</b>	Readout of current sash % open
<b>Actual Flow</b>	Readout of current measured flow
<b>Save &amp; Continue</b>	Use to save data point
<b>Set flow for</b>	Desired face velocity

- b. Perform a face velocity traverse using a thermal anemometer. Compare the face velocity traverse reading to the face velocity set point.
  - c. Adjust the Desired Flow to change the flow control set point for the 24-inch sash position until actual face velocity matches the Set flow for set point.
  - d. Repeat steps b. and c. as needed before selecting **Save & Continue** to save the sash mid-point calibration.
6. Controller will prompt “**Lower sash to 2 inches height then press ↵.**” Lower the sash(es) to the 2-inch height, so the sash(es) are nearly closed, and press the ↵ key.

- a. The FHC50 controller will display the following items:

- b. Perform a face velocity traverse using a thermal anemometer. Compare the face velocity traverse reading to the face velocity set point.

<b>Desired Flow</b>	Flow set point to achieve desired face velocity
<b>Show Sash % Open</b>	Readout of current sash % open
<b>Actual Flow</b>	Readout of current measured flow
<b>Save &amp; Continue</b>	Use to save data point
<b>Set flow for</b>	Desired face velocity

- c. Adjust the Desired Flow to change the flow control set point for the 24-inch sash position until actual face velocity matches the Set flow for set point.
  - d. Repeat steps b. and c. as needed before selecting **Save & Continue** to save the sash closed calibration.
7. Controller will display “**Sash position vs. flow is done calibrating. Press ↵.**” Press the ↵ key to save calibration and continue.

## Flow Calibration

Flow can be measured using a Pressure Flow Station, Linear Flow Station, LOM Venturi, 6-Pt Venturi, or Calculated from face velocity and open sash area.

### Pressure Flow Station Calibration

NOTE
Flow stations are optional and may not be installed in your system.

1. Enter **CALIBRATE FLOW** item.
2. Set **FLO STA AREA** to the duct area at the flow station location.
3. Set **FLO STA PRESS FS** to match the range of the pressure transducer used.

#### *Flow Station Pressure Transducer Zero*

1. Disconnect tubing between pressure transducer and flow station.
2. Select **FLO STA PRESS ZERO** menu item.
3. Press the **ENTER (↵)** soft key. Flow zero procedure, which takes 10 seconds, is automatic. During the 10 second flow zero procedure, the display will indicate the current flow station pressure transducer voltage.
4. Connect tubing between pressure transducer and flow station.

#### *Low Flow Calibration*

1. Set **FLO STA FS V** to match the voltage output (0 to 10V or 0 to 5V) of the pressure transducer used.
2. Close the sash.
3. Select **FLO STA LO CAL** to enter a submenu with the following items:

<b>FLO STA LO SETPT</b>	Damper position for low flow calibration
<b>PRESS ZERO VOLTAGE</b>	Voltage from pressure transducer during Flow Station Pressure Transducer Zero
<b>PRESSURE VOLTAGE</b>	Current voltage from pressure transducer
<b>MEASURED FLOW</b>	Current flow rate
<b>ENTER ACTUAL FLOW</b>	Input actual flow as measured with reference instrument here

5. With the **FLO STA LO SETPT** at 0% (default), observe the **PRESSURE VOLTAGE** displayed on the screen, or use a voltmeter to read the voltage at the pressure input terminals 7-8 on the back of the controller.
6. Slowly *increase* the **FLO STA LO SETPT** percentage value to adjust the damper position until the **PRESSURE VOLTAGE** (pressure transducer output) shows the first noticeable increase in voltage from the 0% position. A general rule of thumb is that the voltage change should occur with the damper between approximately 10 to 30% open.

NOTE
Adjusting the <b>FLO STA LO SETPT</b> with the quick keys allows the <b>PRESSURE VOLTAGE</b> to be displayed in real time.

7. For reference only, the **MEASURED FLOW** item will display the default measured flow based on the current settings of the flow station (duct area, etc.).
8. Determine the actual flow with a duct traverse.
9. Enter the actual flow measurement under the **ENTER ACTUAL FLOW** menu item.
10. Press the **ENTER** (↵) soft key to save the flow data.
11. The low flow calibration is complete. Exit the menu with the **ESC** key.

### **High Flow Calibration**

1. Enter **CALIBRATION FLOW** menu and raise the sash height to approximately 18 inches (sash stop).
2. Select **FLO STA HI CAL** to enter a submenu with the following items:

<b>FLO STA LO SETPT</b>	Damper position for low flow calibration
<b>PRESS ZERO VOLTAGE</b>	Voltage from pressure transducer during Flow Station Pressure Transducer Zero
<b>PRESSURE VOLTAGE</b>	Current voltage from pressure transducer
<b>MEASURED FLOW</b>	Current flow rate
<b>ENTER ACTUAL FLOW</b>	Input actual flow as measured with reference instrument here

3. With the **FLO STA HI SETPT** at 100% (default), observe the **PRESSURE VOLTAGE** displayed on the screen, or use a voltmeter to read the voltage at the pressure signal transducer input terminals 7-8 on the back of the controller.
4. Slowly *decrease* the **FLO STA HI SETPT** percentage value to adjust the damper position until the **PRESSURE VOLTAGE** (pressure transducer output) shows the first noticeable *decrease* in voltage from the 100% position. A general rule of thumb is that the voltage change should occur with the damper between approximately 70 to 90% open.

<b>NOTE</b>
Adjusting the <b>FLO STA HI SETPT</b> with the quick keys allows the <b>PRESSURE VOLTAGE</b> to be displayed in real time.

5. For reference only, the **MEASURED FLOW** item will display the default measured flow based on the current settings of the flow station (duct area, etc.).
6. Determine the actual flow with a duct traverse.
7. Enter the actual flow measurement under the **ENTER ACTUAL FLOW** menu item
8. Press the **ENTER** (↵) soft key to save the flow data.
9. The high flow calibration is complete. Exit the menu with the **ESC** key.

<b>NOTE</b>
Use <a href="#">BALANCE MODE</a> to verify flow station calibration.

## Linear Flow Station Calibration

### NOTE

Flow stations are optional and may not be installed in your system.

1. Enter **CALIBRATE FLOW** item.
2. Set **FLO STA AREA** to the duct area at the linear flow station location.
3. Set **FLO STA TOP VEL** to match the range of the linear flow station used.
4. Set **FLO STA FS V** to match the voltage output (0 to 10V or 0 to 5V) of the linear flow station used.
5. Linear flow station calibration should be complete. Exit the menu.

### NOTE

Use [BALANCE MODE](#) to verify flow station calibration.

## LOM Venturi Calibration

### NOTE

LOM Venturi Valves are optional and may not be installed in your system.

1. Obtain the venturi valve minimum and maximum flow, either by reading the label on the venturi valve or by performing duct traverses when the venturi valve is fully closed and fully opened.
2. Enter **CALIBRATE FLOW** item.
3. Set **VENTURILOM MIN** to the minimum venturi valve flow.
4. Set **VENTURILOM MAX** to the maximum venturi valve flow.
5. LOM Venturi Calibration can be adjusted using the Flow KFactor item.
6. LOM venturi valve calibration is now complete. Exit the menu.

### NOTE

Use [BALANCE MODE](#) to verify LOM Venturi calibration.

## 6Pt Venturi Calibration



### NOTE

6Pt Venturi Valves are optional and may not be installed in your system.

If venturi valve flow data cannot be obtained from venturi valve label, perform duct traverse with venturi valve at 0%, 20%, 40%, 60%, 80% and 100% open (see item [CONTROL OUT](#) in **DIAGNOSTICS** menu).

1. Obtain the venturi valve calibration data by reading the label on the venturi valve.
2. Enter **CALIBRATE FLOW** item.
3. Enter venturi valve minimum flow in item **VENTURI PT1**.
4. Enter 2nd point flow in item **VENTURI PT2**.
5. Enter 3rd point flow in item **VENTURI PT3**.
6. Enter 4th point flow in item **VENTURI PT4**.
7. Enter 5th point flow in item **VENTURI PT5**.



8. Enter 6th point flow in item **VENTURI PT6**.
9. 6pt venturi valve calibration is now complete. Exit the menu.

NOTE
Use <a href="#">BALANCE MODE</a> to verify 6Pt Venturi calibration.

### Calculated Flow Calibration

	NOTE
	Calibrating Calculated Flow requires first calibrating the Face Velocity using the Sidewall Sensor and calibrating the Sash Pot.

1. Enter **CAL SASH AREA** menu item.
2. Controller will display current sash position and prompt “**Fully close sash then press ↵.**” Close the sash and press the ↵ key. After closing the sash(es) and pressing the ↵, controller will count down for 5 seconds while it allows control to stabilize.
3. Controller will prompt to “**Enter Actual Flow**”. Perform a duct traverse or otherwise measure fume hood exhaust volume and enter it into the controller.
4. Press the **ESC** key to continue.
5. Controller will display current sash pot position and prompt “**Fully open sash then press ↵.**” Open the sash and press the ↵ key. After opening the sash and pressing the ↵, controller will count down for 5 seconds while it allows control to stabilize.
6. Controller will prompt to “**Enter Actual Flow**”. Perform a duct traverse or otherwise measure fume hood exhaust volume and enter it into the controller.
7. Press the **ESC** key to continue.
8. Controller will display “**Sash area vs position is calibrated. Press ↵.**” Press the ↵ key to save calibration.

NOTE
Use <a href="#">BALANCE MODE</a> to verify Calculated Flow calibration or use <b>CALIBRATE FLOW</b> item to adjust the <b>FLOW K-FACTOR</b> .

### Sash Opening Calibration

The Sash Opening may be calibrated using a Sash Pot (Vertical Sash Sensor).

#### Calibrate Sash Pot

1. Enter **CAL SASH POT** item.
2. Controller will display current sash pot voltage and prompt “**Fully close sash then press ↵.**” Close the sash(es) and press the ↵ key.
3. Controller will display current sash pot voltage and prompt “**Fully open sash then press ↵.**” Open the sash(es) and press the ↵ key.
4. Controller prompts “**Sash position sensor is calibrated. Press ↵.**” Press the ↵ key to save calibration and exit the menu.
5. Verify Sash Pot calibration by entering the Show Sash%Open item in the [DIAGNOSTICS](#) menu.
  - a. For fume hoods with a single vertical sash, verify that the displayed sash opening moves from 0% to 100% as the sash is moved from full closed to full open.

- b. For fume hoods with two vertical sashes, verify that the displayed sash opening is:
  - i. 0% with both sashes closed.
  - ii. 50% with 1 sash open and 1 sash closed. Verify operation with each sash individually opened.
  - iii. 100% with both sashes open.
- c. For fume hoods with 3 vertical sashes, verify that the displayed sash opening is:
  - i. 0% with all sashes closed.
  - ii. 33% with 1 sash open and 2 sashes closed. Verify calibration with each of the 3 sashes individually opened.
  - iii. 66% with 2 sashes open and 1 sash closed. Verify calibration with each of the 3 sashes individually closed.
  - iv. 100% with all sashes open.



**NOTE**

Verify Sash Pot Calibration to ensure proper wiring and installation.

## Optimizing Controller Performance

The Model FHC50 controller uses both integral and PI control methods. Integral control (slower control signal) is used when the controller is near set point. Integral control provides stability when natural system fluctuations occur such as operators working at hoods and lab doors opening. PI control (fast control) is used when responding to large disturbances to face velocity such as sash movements. PI control rapidly returns the face velocity to set point, thus assuring containment. Once the controller is in PI control, it continues to control in this mode until the operating set point is met.

There are four menu items that change the characteristics of the control output signal;

- 1) SENSITIVITY
- 2) SPEED
- 3) Kc VALUE
- 4) Ti VALUE

TSI® recommends only adjusting the **SENSITIVITY** and **SPEED** to fine tune the control signal. Only when the **SPEED** and **SENSITIVITY** items cannot provide a stable system should **Kc VALUE** and **Ti VALUE** be adjusted. The role of each menu item is covered in the [Menu and Menu Items](#) section of the manual. This section provides some guidance of when a menu item should be changed.

The controller is shipped with PI values that are appropriate for 95+ % of the fume hoods installed. In fume hoods where some adjustment is needed, minor changes to the **SENSITIVITY** and **SPEED** menu items will yield excellent control. The **SENSITIVITY** item selects when the unit goes into PI control. Each percent of the setting from 100% indicates that the controller must be 1 ft/min away from control set point prior to activating PI control. If the **SENSITIVITY** setting is 60% (40% missing), the face velocity must be 40 ft/min off set point before PI control is activated. Conversely, if the **SENSITIVITY** setting is 80% (20% missing), the face velocity must only be 20 ft/min off set point before PI control is activated. The default of 80% is usually a good compromise between PID and integral control.

The **SPEED** menu item slows down the control output. The controller is shipped with a control signal capable of rotating the damper 90 degrees in 1.5 seconds. This may be too fast if the damper is in an unstable flow area (very near the exhaust fan), or there are competing air flows in

the laboratory. Controllers modulating a VFD system will probably need to be slowed down, since the control signal is substantially faster than the VFD/fan can respond.

The remaining menu items, **Kc VALUE** and **Ti VALUE** should not be adjusted unless severe stability problems exist. Adjusting these variables may improve the response and stability, but the exact opposite may happen causing the controller to become unstable, hunt substantially, or have very slow response. If controller performance cannot be improved by adjusting the **SPEED** and **SENSITIVITY**, the two menu items can be manually set to their default values.

---

## Maintenance and Repair Parts

The Model FHC50 Fume Hood Controller requires minimal maintenance. Periodic inspections of system components as well as an occasional velocity sensor cleaning are all that are needed to ensure that the Model FHC50 is operating properly. The Model FHC50 should be calibrated annually. Refer to the [Calibration](#) section for further information.

### System Component Inspection

It is recommended that the velocity sensor be periodically inspected for accumulation of contaminants. The frequency of these inspections is dependent upon the quality of the air being drawn across the sensor. Quite simply, if the laboratory air is dirty, the sensors will require more frequent inspection and cleaning.

Visually inspect the velocity sensor. The air flow orifice should be free of obstructions. The small, cylindrical, ceramic sensor protruding from the orifice wall should be white and free of accumulated debris.



**Figure 5: Velocity Sensor**

Periodically inspect the other system components for proper performance and physical signs of excessive wear.

### Velocity Sensor Cleaning

Accumulations of dust or dirt can be removed with a dry soft-bristled brush (such as an artist's brush). If necessary, water, alcohol, acetone, or trichlorethane may be used as a solvent to remove other contaminants.

Use extreme care when cleaning the velocity sensors. The ceramic sensor may break if excessive pressure is applied, if sensor is scraped to remove contaminants, or if the cleaning apparatus abruptly impacts the sensor.

	<b>WARNING</b>
	If you are using a liquid to clean the sensor, turn off power to the Model FHC50. <b>DO NOT</b> apply power before velocity sensor completely dries.
	<b>DO NOT</b> use compressed air to clean the velocity sensors.
	<b>DO NOT</b> attempt to scrape contaminants from the velocity sensors. The velocity sensors are quite durable; however, scraping may cause mechanical damage and possibly break the sensor. Mechanical damage due to scraping voids the sensor warranty.

## Replacement Parts

All components of the Face Velocity Control system are field replaceable. Contact TSI® or your nearest TSI® Manufacturer's Representative for replacement part pricing and delivery.

Part Number	Description
Found on back of unit	Model FHC50 Fume Hood Controller
800320	Velocity Sensor
800325	Velocity/Controller Sensor Cable
800414	Transformer Cable
800199	Controller Output Cable
800380	Electric Actuator

---

## Troubleshooting Section

The Model FHM10 Fume Hood Monitor and FHC50 Fume Hood Controller is designed to be trouble free. However, installation problems or interaction with other HVAC components may cause system problems. The system is easy to troubleshoot if an organized approach to evaluate the system is taken. Troubleshooting is broken down into hardware (mechanical) and software problems. Hardware problems deal with the physical installation of the device. Hardware problems include wiring problems, incorrectly installed equipment, and add-ons or non-TSI® equipment. Software problems include control problems, configuration problems, or interaction problems with the HVAC system.

The hardware test described in this section determines that all TSI® mechanical components are functioning correctly. The hardware test requires the diagnostics menu items to be accessed. If you are unfamiliar with the controller menus, see [Software Programming](#) for keystroke procedure. Troubleshooting the majority of problems is usually quick if the hardware test is followed.

Software and hardware problems are covered in the troubleshooting chart. Pick the problem that most closely resembles your problem and review the possible symptoms and corrective action. Software or system performance problems can and are affected by the supply air system, exhaust air system, or physical configuration of the room. Separating TSI® system problems from the laboratory HVAC system can sometimes be difficult. TSI® recommends confirming all hardware is operating correctly before troubleshooting software problems.

## Hardware Test

Three tests need to be performed in order to determine all hardware is functioning correctly. The tests are broken down into:

- [Confirming wiring is correct.](#)
- [Confirming physical installation is correct.](#)
- [Verifying mechanical components.](#)

### Confirming wiring is correct

The most common problem with installed hardware equipment is incorrect wiring. This problem usually exists on initial installation, or when modifications to the system take place. The wiring should be very closely checked to verify it *exactly* matches the wiring diagram. Wiring diagrams are located in [Appendix C](#) of this manual. Wiring associated with non-TSI® components should be closely checked for correct installation. If non-TSI® components are installed, consider disconnecting them for testing purposes.

### Confirming physical installation is correct

All of the hardware components need to be installed properly. Review the installation instructions and verify components are installed properly at the correct location. This is easily done when the wiring is checked.

### Verifying mechanical components

Verifying all TSI® components are operating correctly requires following a simple procedure. The fastest procedure to confirm all equipment is operating is to first test the Digital Interface Module (DIM), and then go into the diagnostic menu to test each component.

#### NOTE

These tests require power to the units, so if unit has no power, refer to hardware troubleshooting chart to eliminate power problem.

### TEST - DIM

Enter the **SELF TEST** menu item in the diagnostics menu to verify DIM electronics are functioning correctly. During the self test, the display will show the model number and software revision of the controller. At the end of the self test, the display will show a message. The display shows:

- **NO ERRORS** if all DIM electronics are good.
- **FRAM** error if settings may have been lost. Press **RESET** to clear error and check all settings for correct values.
- **CALIB** error if sensor calibration may have been lost. Verify face velocity, sash sensor and/or flow calibration.

If **NO ERRORS** is displayed, proceed to test individual components in the [Diagnostics Menu](#). If the controller passes each of the tests, the mechanical piece parts are all functioning correctly.

*(continued on next page)*

## Diagnostics Menu



The items in the Diagnostic Menu aid in identifying problems the staff may encounter. Upon entering the Diagnostics Menu, all of the associated outputs hold at their most recent state. Output can be temporarily changed by entering the item or by pressing the quick keys. No permanent change occurs with these menu items. All of the associated inputs in the Diagnostics Menu will continually update in order to monitor their function. The Diagnostics menu is exited by pressing the **ESC** soft key. When the Diagnostics menu is exited, the controller returns to its normal state.

Menu Item	Description
<b>Control Output</b>	
<b>CONTROL OUT</b>	Enter <b>CONTROL OUT</b> menu item in diagnostics menu. A number between 0% open and 100% open representing the current damper or venturi valve position will be displayed. Close the damper or venturi valve fully using the quick keys or entering the <b>CONTROL OUT</b> item and using the ▼ key. Note the position of the control damper or venturi valve. Open the damper or venturi valve fully using the quick keys or the ▲ key. The damper should have rotated 90 degrees, or the venturi valve should have moved its full stroke. If the damper rotated less than 85 degrees (or the venturi valve moved less than 90% of full stroke), see <a href="#">Troubleshooting chart: Control system is not controlling</a> . If the damper or valve is fully closed when the <b>CONTROL OUT</b> item is 100% open, change direction of control using <b>CONTROL SIG</b> item in <b>CONTROL</b> menu.
	<b>WARNING</b>
	The <b>CONTROL OUT</b> function overrides the face velocity or flow control signal. Adequate face velocity or flow will <b>NOT</b> be maintained while in this menu item.
<b>Velocity Sensor Input</b>	
<b>VEL SENSOR INPUT</b>	The <b>VEL SENSOR INPUT</b> item verifies that the controller electronics is receiving a signal from a sidewall sensor. When this item is entered, a voltage will be indicated on the display. The exact number displayed is relatively unimportant. It is more important that the displayed number changes when the velocity changes (blow on sensor, move sash, etc.). If display does not change, see <a href="#">Troubleshooting chart</a> ; “ <b>SENSOR ERROR</b> ” flashing on display.
<b>SHOW FACE VEL</b>	The <b>SHOW FACE VEL</b> item is used to display the current face velocity, either as measured by a sidewall sensor or calculated from exhaust flow rate and open sash area.
	<b>NOTE</b>
	If face velocity does not match actual readings, recalibrate face velocity.

Menu Item	Description
<b>Flow Station Input</b>	
<b>FLOW ANALOG INPUT</b>	<p>The <b>FLOW ANALOG INPUT</b> item is used to read the input from the flow station. When this item is entered, a voltage is indicated on the display. The exact number displayed is relatively unimportant. It is more important that the voltage is changing which indicates the flow station is working correctly.</p> <p>0 VDC displayed equals zero flow. 10 VDC displayed equals maximum flow.</p>
<b>NOTE</b>	
FHM10 monitors and FHC50 controllers can be field configured so 5 VDC displayed equals maximum flow.	
<b>Show Flow</b>	
<b>SHOW FLOW</b>	<p>The <b>SHOW FLOW INPUT</b> item is used to display the current measured or calculated rate of the fume hood exhaust flow in cfm, l/s or m<sup>3</sup>/hr.</p>
<b>NOTE</b>	
If flow does not match actual readings, recalibrate flow.	
<b>Analog Output</b>	
<b>ANALOG OUT</b>	<p>The <b>ANALOG OUT</b> item varies the analog output from the unit. When this item is entered, a number will be shown on the display indicating the last analog output value. The value displayed ranges from 0 to 100%. The value 0% corresponds to 0 volts (4 mA) output and 100% corresponds to 10 Volts (20 mA) output. Pressing the ▲ key will increase the analog output. Pressing the ▼ key will decrease the analog output.</p> <p>The <b>ANALOG OUT</b> function can be used in conjunction with a volt meter to verify the analog output is correct.</p>
<b>Alarm Relay A</b>	
<b>ALARM RELAY A</b>	<p>The <b>ALARM RELAY A</b> item changes the state of the alarm relay. When this item is entered, the display will indicate either <b>OK</b> or <b>ALARM</b>. The ▼/▲ keys are used to toggle the state of the relay. See menu item <b>RELAYS OUT</b> under the <b>CONFIGURE</b> menu for the desired contact state (<b>OK=OPEN</b> or <b>OK=CLOSED</b>) during an alarm condition.</p>
<b>Alarm Relay B</b>	
<b>ALARM RELAY B</b>	<p>The <b>ALARM RELAY B</b> item changes the state of the alarm relay. When this item is entered, the display will indicate either <b>OK</b> or <b>ALARM</b>. The ▼/▲ keys are used to toggle the state of the relay. See menu item <b>RELAYS OUT</b> under the <b>CONFIGURE</b> menu for the desired contact state (<b>OK=OPEN</b> or <b>OK=CLOSED</b>) during an alarm condition.</p>

Menu Item	Description
<b>Sash Contact Input</b>	
<b>IN# SASH CONTACT</b>	The <b>IN# SASH CONTACT</b> item reads the current state of a sash contact input. This item will only be displayed when the corresponding <b>INPUT SEL #</b> item has been set to <b>SASH CONTACT</b> under the <b>CONFIGURE</b> menu. When this item is entered, the display will indicate either <b>OPEN</b> or <b>CLOSED</b> . If the display indicates closed, the unit is in High Sash Alarm mode.
<b>NOTE</b>	
<b>IN# SASH CONTACT</b> is a read-only menu item.	
<b>Emergency Contact Input</b>	
<b>IN# EMERG PURGE</b>	The <b>IN# EMERG PURGE</b> item reads the current state of an emergency contact input. This item will only be displayed when the corresponding <b>INPUT SEL #</b> item has been set to <b>EMERG PURGE</b> under the <b>CONFIGURE</b> menu. When this item is entered, the display will indicate either <b>OPEN</b> or <b>CLOSED</b> . If the display indicates <b>CLOSED</b> , the controller has been put into emergency mode through the contact input. If the display indicates <b>OPEN</b> , the controller has not been put into emergency mode through the contact input. However, the controller may be in emergency mode if it has been initiated through the keypad or via network communications.
<b>NOTE</b>	
<b>IN# EMERG PURGE</b> is a read-only menu item.	
<b>Setback Input</b>	
<b>IN# NIGHT SETB</b>	The <b>IN# NIGHT SETB</b> item reads the current state of a setback contact input. This item will only be displayed when the corresponding <b>INPUT SEL #</b> item has been set to <b>NIGHT SETB</b> under the <b>CONFIGURE</b> menu. When this item is entered, the display will indicate either <b>OPEN</b> or <b>CLOSED</b> . If the display indicates <b>CLOSED</b> , the controller has been put into setback mode through the contact input. If the display indicates <b>OPEN</b> , the controller has not been put into setback mode through the contact input. However, the controller may be in setback mode if it has been initiated through the keypad or via network communications.
<b>NOTE</b>	
<b>IN# NIGHT SETB</b> is a read-only item.	
<b>Sash Position Input</b>	
<b>IN1 SASH POS VER</b>	The <b>IN1 SASH POS VER</b> item is used to read the input from the sash position potentiometer. This item will only be displayed when the <b>INPUT SEL 1</b> item has been set to <b>SASH POS VERT</b> under the <b>CONFIGURE</b> menu. When this item is entered, a voltage is indicated on the display. The exact number displayed is relatively unimportant. More important is that as the fume hood sash is moved, the voltage on the display should also change, which indicates the sash position potentiometer is working correctly.
<b>NOTE</b>	
<b>IN1 SASH POS VER</b> is a read-only item.	





Menu Item	Description
<b>Show Sash % Open</b>	
<b>SHOW SASH%OPEN</b>	The <b>SHOW SASH%OPEN</b> item is used to display the current measured or calculated sash open percentage.
<b>Show Sash Open Area</b>	
<b>SHOW SASH AREA</b>	The <b>SHOW SASH AREA</b> item is used to display the current measured or calculated sash open area in ft <sup>2</sup> (or m <sup>2</sup> ).
<b>Unit Self Test</b>	
<b>SELF TEST</b>	Enter the <b>SELF TEST</b> menu item to verify DIM electronics are functioning correctly. During the self test, the display will show the model number and software revision of the controller. At the end of the self test, the display will show <b>NO ERRORS</b> if all DIM electronics are good. If unit displays an <b>FRAM</b> error at the end of the test, settings may be corrupted. Check all menu items to determine cause of <b>DATA ERROR</b> . If unit displays a <b>CALIB</b> error at the end of the test, calibration may have been lost. Verify face velocity, sash sensor and/or flow calibration.
<b>Reset Settings</b>	
<b>RESET SETTINGS</b>	The <b>RESET SETTINGS</b> item is used to change all settings to factory default. <b>RESET SETTINGS</b> will not affect calibration.
	<b>WARNING</b>
	Unconfiguring the unit with the <b>RESET SETTINGS</b> item may change critical settings including control set point. Always reconfigure unit after using <b>RESET SETTINGS</b> item.
<b>Reset Calibration</b>	
<b>RESET ALL CALIBS</b>	The <b>RESET ALL CALIBS</b> item is used to clear field calibration data.
	<b>WARNING</b>
	Clearing field calibration data with the <b>RESET ALL CALIBS</b> item may result in incorrect calibration and/or loss of containment. Always recalibrate unit after using <b>RESET ALL CALIBS</b> item.

## Troubleshooting Chart

Symptom	Possible Cause	Corrective Action
Display is blank.	Fuse is blown.	<p>Measure voltage at pins 1 and 2 on DIM 4-pin connector. The voltage should nominally be:</p> <ul style="list-style-type: none"> <li>24 to 40 VDC when using TSI® electric actuators.</li> <li>24 to 30 VAC when using motor speed drives.</li> </ul> <p>If correct voltage is measured, internal DIM fuse is probably blown. Unplug 4-pin connector from DIM for 2 minutes. The internal fuse will automatically reset. Plug unit back in and check display. If display is still blank, check all wiring, etc.</p> <p>If approximately 5 volts is measured, the fuse in the electric actuator is blown. Disconnect power to the electric actuator for two minutes to reset fuse. Disconnecting power requires either shutting off circuit breaker or disconnecting the wires on pins 1 and 2 on the electric actuator.</p> <p>If zero volts are measured, see <a href="#">No power to DIM</a>.</p> <p>Verify circuit breaker is on.            Verify transformer primary measures 110 VAC.            Verify transformer secondary measures 24 to 30 VAC.</p> <p><i>If using DC power output from TSI® electric actuator:</i></p> <p>Verify electric actuator is receiving 24 to 30 VAC between pins 1 and 2.</p> <p>Verify 18 to 40 VDC is found between pins 3 and 4 of the electric actuator.</p>
	No power to DIM.	<p>Verify circuit breaker is on.</p> <p>Verify transformer primary measures 110 VAC.</p> <p>Verify transformer secondary measures 24 to 30 VAC.</p> <p>Verify 24 to 40 VDC is found between pins 3 and 4 of the electric actuator.</p> <p>Verify DIM voltage on pins 1 and 2 is 24 to 30 VAC for VFD systems, or 32 to 40 VDC on electric actuators.</p>
	DIM is defective.	<p>If proper voltage is found between pins 1 and 2 of the DIM, all wiring has been checked, fuses have been reset, and screen is still blank, the DIM is probably defective. Replace DIM.</p>

## Troubleshooting Chart

Symptom	Possible Cause	Corrective Action
Menu soft key not displayed.	DISPL SOFTKEYS set to OFF.	Press left and right quick-keys and right-most soft key simultaneously to gain access to menu system. Set <b>DISPL SOFTKEYS</b> item in <b>CONFIGURE</b> menu to ON. 
Need to display model number and firmware revision	--	Select <b>SELF TEST</b> item in <a href="#">DIAGNOSTICS menu</a> or display hello screen by simultaneously pressing the three right-most soft keys while in the running screen. 
Controller is not controlling.	Incorrect wiring.	Verify correct wiring (see <a href="#">Wiring diagram</a> ; Appendix C). DIM must be wired exactly as shown.
	Damper/Valve moving opposite direction.	If damper is full open when it should be closed or full closed when it should be open, go into <b>CONTROL</b> menu <b>CONTROL SIG</b> menu item. Change <b>DIRECT</b> to <b>REVERSE</b> or <b>REVERSE</b> to <b>DIRECT</b> to change control output direction.
	No control output signal.	Go into <a href="#">DIAGNOSTICS menu</a> , <b>CONTROL OUT</b> item. A number between <b>0% OPEN</b> and <b>100% OPEN</b> will be displayed. Pressing the ▲ key increases the number. Pressing the ▼ key decreases the number. Measure the DC voltage between pins 1 and 2 (4-pin connector) on the controller. Change the <b>CONTROL OUT</b> value about 40%. The voltage output should change approximately 4 volts. Change the <b>CONTROL OUT</b> value to <b>50% OPEN</b> . The voltage should read approximately 5 VDC.  If no change occurs, disconnect control wires on pins 1 and 2 (4-pin connector) and repeat test. If DIM still fails to change voltage output, DIM is probably defective. If voltage changed DIM is working, and either wiring or actuator (VFD) needs to be examined.

## Troubleshooting Chart

Symptom	Possible Cause	Corrective Action
Controller is not controlling. (continued)	Bad actuator or valve (damper or valve linkage does not move).	<p>Go into <a href="#">DIAGNOSTICS menu</a>, <b>CONTROL OUT</b> item. A number between 0% OPEN and 100% OPEN will be displayed. Pressing the ▲ key increases the number. Pressing the ▼ key decreases the number. Change the <b>CONTROL OUT</b> value to read <b>0% OPEN</b> or <b>100% OPEN</b>. Note damper/valve position. Press an arrow key to change <b>0% OPEN</b> to <b>100% OPEN</b> or <b>100% OPEN</b> to <b>0% OPEN</b>. Note position of damper/valve. Damper should have rotated 90 degrees (or valve linkage moved full stroke). If damper rotated 90 degrees (or valve linkage moved full stroke), actuator is installed and operating correctly.</p> <p>If damper/valve did not move, check that:</p> <ul style="list-style-type: none"> <li>• Damper/valve is not physically stuck (screws, etc.).</li> <li>• Wiring is correct between actuators and controller. Check that voltage varies between 0 and 10 volts on pins 5 and 6 on electric actuator (see <a href="#">No control output signal</a>).</li> </ul> <p>Electric actuator is not over torqued. The electric actuator has current limiting protection. If damper is physically stuck or actuator is over current, the actuator will shut down. To restart either kill power to actuator or move damper/valve in opposite direction (<a href="#">CONTROL OUT</a> menu item).</p>
	Defective variable frequency drive (VFD).	Perform test described in <a href="#">Control system is not controlling</a> . If <b>CONTROL OUT</b> is functioning, verify wiring to VFD by confirming <b>CONTROL OUT</b> voltage changes at VFD. If voltage changes, a problem with VFD exists. See VFD manual for further troubleshooting.
	Damper/Valve is full open or full closed, will not move.	Control wires are loose. Check wires and verify control output is working (see <a href="#">No control output signal</a> ). If control output test passes, verify damper/valve is moving correct direction (see <a href="#">Damper/Valve moving opposite direction</a> ). If damper/valve is moving correctly and set point cannot be reached, DIM will fully move damper/valve to get as close to set point as possible. Fume hood exhaust; fan, static pressure, etc. needs to be adjusted.
	Controller not calibrated.	Calibrate controller. Controller is not calibrated leaving the factory; it must be field calibrated.

## Troubleshooting Chart

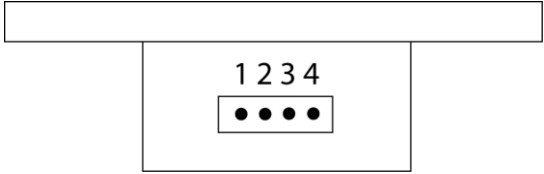
Symptom	Possible Cause	Corrective Action
"Check the Sensor Cable" flashing on display.	Poor sensor connections.	Verify the sensor cable is correctly plugged into the DIM and sensor. Connector is polarized but can be forced on backwards.
	Defective sensor.	Disconnect the velocity sensor cable from the back of DIM. Depress the latching piece on the connector to pull it out. Use an ohm meter to measure the resistance between the sensor connections indicated in figure below. The resistance between pins 3 and 4 should be between 10 and 12.5 ohms. The resistance between pins 2 and 4 should be between 120 and 140 ohms. If resistance does not measure correctly, verify that sensor cable is good.   <p>The diagram shows a rectangular connector with four pins labeled 1, 2, 3, and 4. Pins 1 and 2 are on the left, and pins 3 and 4 are on the right. Each pin is represented by a small circle with a dot in the center.</p>
	Defective sensor cable.	Verify wire is terminated the same on both ends of cable. Confirm wire colors match pin 1 to 1, pin 2 to 2, etc. Test sensor cable with an Ohmmeter to ensure that cable terminations are good.
	Excessive face velocity.	Confirm the fume hood face velocity is over 1000 ft/min. If face velocity exceeds 1,000 ft/min, exhaust system needs balancing.
	Controller not calibrated.	Calibrate controller.
Remote emergency does not work.	Incorrect wiring or defective switch.	Disconnect emergency remote wires from DIM. Verify wiring with an Ohmmeter by switching the emergency switch open and closed. If operational, reconnect to DIM.
	Defective controller.	Verify wiring and switch are good. Enter <a href="#">DIAGNOSTICS menu IN# EMERG PURGE</a> item. Display will indicate <b>OPEN</b> or <b>CLOSED</b> . Toggle the remote emergency switch, and the display should change between <b>OPEN</b> and <b>CLOSED</b> . If no change, replace DIM.
Remote setback does not work.	Incorrect wiring or defective switch.	Disconnect remote wires from DIM. Verify wiring with an Ohmmeter by switching the setback switch open and closed. If operational, reconnect to DIM.
	Defective DIM.	Verify wiring and switch are good. Enter <a href="#">DIAGNOSTICS menu IN# NIGHT SETB</a> item. Display will indicate <b>OPEN</b> or <b>CLOSED</b> . Toggle the remote setback switch, and display should change between <b>OPEN</b> and <b>CLOSED</b> . If no change, replace DIM.

**Figure 6:** Velocity Sensor



## Troubleshooting Chart

Symptom	Possible Cause	Corrective Action
DIM does not respond to network communications/	Network protocol is incorrect.	Go into <a href="#">INTERFACE menu</a> , <b>NET PROTOCOL</b> item. The protocol must match host system. Select correct interface.
	Incorrect network address.	The network address at the building automation system and at the DIM must match. The network address must be unique for each DIM.
	Incorrect polarity.	Verify and/or change polarity of RS-485 A and B wires.
	Incompatible software.	Data sent to DIM may be in form that the controller cannot recognize.
	LonWorks® or BACnet® board not installed.	Contact factory for further assistance.
	Bad LonWorks® or BACnet® board.	Contact factory for assistance.
	Foreign network acquired controller. (LonWorks® only)	Go into <a href="#">CONFIGURE menu</a> , <b>LON</b> item. Select <b>GO UNCONFIG</b> option, press the <b>SELECT</b> key. Return to the <b>LON</b> item, select the <b>SERVICE PIN</b> option and press the <b>SELECT</b> key. Selecting <b>GO UNCONFIG</b> will reset the FHC50's authentication key, allowing the <b>SERVICE PIN</b> to install or reclaim the FHC50 to the LonWorks® network.
Alarm relays do not work.	Alarms are turned off.	Enter the Set Points menu. Verify that the alarm that is supposed to trigger the relay is not set to 0 (OFF). If the alarm set point is zero, alarm relay is not active, so relay will not be required to change state.
	Incorrect wiring.	Check the wiring from DIM relay's output to the device that is connected to the relays.
	Relay may be defective.	Disconnect the wiring (6-pin connector) from relay contact pins 1 and 2 for low alarm relay and pins 3 and 4 for relay "B". Go into <a href="#">DIAGNOSTICS menu</a> , <b>ALARM RELAY A</b> or <b>ALARM RELAY B</b> . Connect an ohm-meter to relay terminals to verify contact open and closes. Press the <b>▲/▼</b> key to manually trip the relay. If relay responds (contact opens and closes), the device connected is incompatible or defective. If relay does not respond, relay is defective (may be caused by incompatible device). Replace DIM.

## Troubleshooting Chart

Symptom	Possible Cause	Corrective Action
Actuator hunting. Display indicates steady velocity.	Control system is unstable.	Go into <a href="#">CONTROL menu</a> , <b>SPEED</b> item. Turn speed down until hunting is eliminated. If speed is too slow see manual section: <a href="#">Optimizing Controller Performance</a> and adjust accordingly to eliminate problem.
Displayed velocity wildly fluctuating.	Exhaust system unstable.	Turn DIM to emergency if using a Model FHC50 controller. If velocity stabilizes, exhaust system is not unstable.
	Laboratory supply air is affecting the sensor.	Check location of supply air diffusers. They should be located as far from the velocity sensor as is realistic, 10 feet preferred, 6 feet minimum. Supply diffuser terminal throw velocity must be less than 50% of the average controlled face velocity. Velocity in the fume hood chase (back side of sensor) should be less than 25% of the average controlled face velocity. The supply diffuser must be relocated if these parameters cannot be met.
	Display averaging is very short.	Lengthen the time constant by entering the <a href="#">CONFIGURATION menu</a> , <b>DISPLAY AVG</b> item, and increase the average time.
	Controller needs calibration.	Calibrate controller.
Analog output does not work properly.	Controller is connected to incompatible equipment.	Enter the <a href="#">DIAGNOSTICS menu</a> , <b>ANALOG OUT</b> item. A number is displayed. Connect a voltmeter to pins 5 and 6 (6 pin connector). Pressing the ▲ key increases the displayed number and increases the voltage (current) output. Pressing the ▼ key decreases the number and decreases the voltage (current) output. If no change occurs, disconnect the analog out device and repeat above procedure. If voltage now changes, the controller is good, and the external device is defective. If no change occurs, DIM is defective.
Displayed velocity does not match measured velocity.	Velocity sensor is dirty.	See <a href="#">Maintenance and Repair Parts</a> .
	Controller is not calibrated.	See <a href="#">Calibration</a> .
	Velocity sensor is not referenced to room air.	The velocity sensor must reference air from the same space as the fume hood space. If fume hood cabinet extends above to the ceiling, a Model 8691 Sensor Venting Kit must be installed.
Display does not read zero flow at zero flow.	Controller is not calibrated.	See <a href="#">Calibration</a> .
	Velocity sensor is not referenced to room air.	The velocity sensor must reference air from the same space as the fume hood space. If fume hood cabinet extends above to the ceiling, a Model 8691 Sensor Venting Kit must be installed.

## Troubleshooting Chart

Symptom	Possible Cause	Corrective Action
<b>Caution</b> light on continuously. Display indicates steady velocity.	Monitor/controller is in setback mode.	Display will read <b>SETBACK</b> . Press <b>SETBACK</b> key, and control should return to normal.
	Monitor/controller is muted.	Display will read Mute. Press <b>Mute</b> key to return to normal function.
“Flow Calibration Required” on the display	Flow measurement needs calibration.	Calibrate flow using instructions in <a href="#">Calibration</a> section.
“Cannot Measure Flow” on the display	Low pressure drop across venturi valve with feedback.	Verify venturi valve pressure drop with a micromanometer like TSI® DP-Calc™ Model 5825. Adjust fan or other flows to provide sufficient duct static pressure.
	No power to venturi valve feedback module.	Verify 24 VAC power provided to venturi valve feedback module.
	Sash sensor not connected or malfunctioned.	Enter <a href="#">DIAGNOSTICS menu</a> and view menu item <b>IN1 SASH POS VER</b> . Sash input should be at minimum (maximum) when sash(es) are open and maximum (minimum) when sash(es) are closed.
“The configuration is not supported. Reconfiguration is required.” on the display.	Incorrect configuration.	Run Configuration Wizard to correct configuration.
“LON OVERRIDE ON” on the display	BAS Communications have taken control of FHC50.  	Release control at BMS to clear.
		WARNING
		Adequate face velocity may not be maintained while LON overrides the control signal.
“EMERGENCY” on the display.	Unit put into Emergency mode.	Verify chemical spill or other reason Emergency mode was enabled has been resolved. Exit Emergency Mode by pressing: 
“Check the Sash Pot” on the display.	Sash Sensor slipped.	Reconnect sash sensor to fume hood sash cable and recalibrate sash sensor.



## Troubleshooting Chart

Symptom	Possible Cause	Corrective Action
<p>Error message on display.</p> <p>Error messages:</p> <ul style="list-style-type: none"> <li>• ADC Read Error</li> <li>• Interrupt Fail Error</li> <li>• Data C Checksum Error</li> <li>• Data U Checksum Error</li> <li>• I2C FRAM Write Error</li> <li>• Flow Setup Data Error</li> <li>• Control Calib Data Error</li> <li>• AOut Calib Data Error</li> <li>• AIn Calib Data Error</li> <li>• Configuration Data Error</li> <li>• Meter ID Data Error</li> <li>• FRAM RD Meter ID Error</li> <li>• FRAM RD User Config Error</li> <li>• FRAM Rd Meas Cals Error FRAM Rd Control Cal Error</li> <li>• FRAM Rd Aout Cal Error</li> <li>• FRAM Rd Ain Cal Error</li> <li>• FRAM Rd Stored Errs Error</li> <li>• FRAM Wr Stored Errs Error</li> <li>• FRAM Wr Clear Errs Error</li> <li>• FRAM Wr Changed Data Error</li> <li>• FRAM Wr Clear FRAM Error</li> <li>• Flow Calib Data Error</li> <li>• Sash Position Calib Error</li> <li>• Sash Sensor Calib Error</li> <li>• Sash Area Calib Error</li> <li>• Vel Calib Data Error</li> </ul>	<p>Internal error in monitor or controller.</p>	<p>Clear error using <a href="#">Self Test</a> item in <a href="#">DIAGNOSTICS menu</a>. If error recurs, return unit to factory.</p>

*(This page intentionally left blank)*

## Appendix A

### Specifications\*

<b>Digital Interface Module</b>	
<b>Display</b>	
Range .....	0 to 1,000 ft/min (0 to 5.08 m/s) 0 to 10,000 cfm (0 to 4,720 l/s, 0 to 16,990 m <sup>3</sup> /hr.)
Resolution .....	1 ft/min (0.01 m/s) 1 cfm (1 l/s, 1 m <sup>3</sup> /hr.)
<b>Inputs</b>	
Type .....	Three (3) Total Choice of: Sash Position, Sash Contact, Setback In, Emergency In
Signal .....	Sash Position: 0-10,000 $\Omega$ Sash Contact, Setback In, Emergency In: SPST (N.O.) Switch. Closing switch initiates condition.
Flow Input .....	0 to 10VDC Pressure-based flow station, linear flow station or venturi valve with feedback
<b>Outputs</b>	
Analog Output Type .....	0 to 10 VDC or 4 to 20 mA
Range .....	0 to configurable maximum representing face velocity, flow or sash position
Alarm Contacts .....	SPST, 60 W max 2A @ 30 VDC Nominal Contacts field-configurable to open or close in alarm condition. Contacts close on loss of power.
Low Alarm Range .....	5 to 980 ft/min (0.03 to 4.88 m/s) 0 to 10,000 cfm (0 to 4,720 l/s, 0 to 16,990 m <sup>3</sup> /hr.)
High Alarm Range .....	80 to 1,000 ft/min (0.41 to 5.08 m/s) 0 to 10,000 cfm (0 to 4,720 l/s, 0 to 16,990 m <sup>3</sup> /hr.)
Communications Protocols .....	Modbus <sup>®</sup> RTU or N2 (standard) 9600 baud BACnet <sup>®</sup> MS/TP (Optional) 76.8k, 38.4k 19.2k, 9600 baud) LonWorks <sup>®</sup> (Optional)
Operating Temperature .....	32 to 120°F (0 to 48.9°C)
Input Power .....	24 VAC, 50/60 Hz 15 to 40 VDC 5 Watt maximum (50 VA with TSI <sup>®</sup> Actuator)
Dimensions .....	6.67 in x 2.92 in x 1.25 in (169 mm x 74 mm x 32 mm)
Weight .....	0.5 lb. (0.2 kg)

<b>Velocity Sensor</b>	
Range .....	0 to 1,000 ft/min (0 to 5.08 m/s)
Resolution.....	1 ft/min (0.00508 m/s)
Temperature Compensation Range .....	55 to 95°F
Power Dissipation.....	0.09 watts at 0 ft/min. (0 m/s) 0.14 watts at 100 ft/min. (0.508 m/s)
Dimensions (D x H) .....	2.75 in. × 1.25 in. (70 mm × 32 mm)
Weight.....	0.2 lb. (0.1 kg)
Sensor Cable Specifications .....	4-conductor, 22 AWG, 4-pin polarized at both ends with a standard length of 6 ft (a maximum length of 10 ft).
<b>Vertical Sash Sensor</b>	
Cable Type .....	Nylon-coated stainless steel
Maximum Retraction.....	50 in. (1,270 mm)
Resistance .....	0 to 10,000 Ω
Electrical Cable.....	2-conductor, 24 AWG 12 ft (3.6 m)
Dimensions .....	2.0 in × 3.5 in × 3.1 in (51 mm × 88 mm × 79 mm)
<b>Damper/Actuator</b>	
Types of Actuator .....	Electric
Input Power.....	Electric: 24 VAC, 50 VA max
Time for 90° Rotation.....	1.5 sec.

*\*Specifications are subject to change without notice.*

## Appendix B

---

### Network Communications

Network communications are available on the Model FHC50. The Model FHC50 can communicate with a building management system through Modbus®, N2, LonWorks® or BACnet® MS/TP protocols. Please refer to the appropriate section below for more detailed information.

---

### Modbus® Communications

Modbus® communications are installed in the Model FHC50 fume hood controllers. This document provides the technical information needed to communicate between the host DDC system and the Model FHC50 units. This document assumes the programmer is familiar with Modbus® protocol. Further technical assistance is available from TSI® if your question is related to TSI® interfacing to a DDC system. If you need further information regarding Modbus® programming in general, please contact:

Modicon Incorporated (a division of Schneider-Electric)  
One High Street  
North Andover, MA 01845  
Phone (800) 468-5342

The Modbus® protocol utilizes the RTU format for data transfer and Error Checking. Check the Modicon Modbus® Protocol Reference Guide (PI-Mbus-300) for more information on CRC generation and message structures.

The messages are sent at 9600 baud with no start bit, 8 data bits, and 2 stop bits. Do **not** use the parity bit. The system is set up as a master slave network. The TSI® units act as slaves and respond to messages when their correct address is polled.

Blocks of data can be read from each device. Using a block format will speed up the time for the data transfer. The size of the blocks is limited to 255 bytes. This means the maximum message length that can be transferred is 255 bytes. The typical response time of the device is around 0.05 seconds with a maximum of 0.1 seconds.

#### Unique to TSI®

The list of variable addresses shown below skips some numbers in the sequence due to internal Model FHC50 functions. This information is not useful to the DDC system and is therefore deleted. Skipping numbers in the sequence will not cause any communication problems. If a variable is not used by the particular FHC50 configuration, it will be reported with a value of -1.

All variables are outputted in English units: ft/min, and cfm. If the DDC system is to display different units, the DDC system needs to make the conversion.

#### Network Points

These variables can be read using Modbus® command **03 Read Holding Registers**. They can be written to using Modbus® command **06 Write Single Register**. Many of these variables are the same “menu items” that are configured from the controller keypad. The calibration and control items are not accessible from the DDC system. This is for safety reasons since each hood is individually setup for maximum performance.

---

Modbus is a registered trademark of Modicon, Inc.

**Modbus Communications** (continued)

**FHC50 Variable List**

<b>Feature</b>	<b>Holding Register (Decimal)</b>	<b>Range</b>	<b>Unit</b>	<b>Read / Write</b>	<b>Notes</b>
Face Velocity	40001	0 to 1000	fpm	R	
Current Face Velocity Setpoint	40002	0 to 1000	fpm	R	
Flow Rate	40003	0 to 10000	cfm	R	
Current Flow Rate Setpoint	40004	0 to 10000	cfm	R	
Damper or Valve Position	40005	0 to 100	%	R	
Sash Position Percent	40006	0 to 100	%	R	
Sash Open Area	40007	0 to 1000	ft <sup>2</sup> * 100	R	
Low Velocity Alarm Status	40008	0, 1	0: Inactive 1: Active	R	
High Velocity Alarm Status	40009	0, 1	0: Inactive 1: Active	R	
Low Flow Alarm Status	40010	0, 1	0: Inactive 1: Active	R	
High Flow Alarm Status	40011	0, 1	0: Inactive 1: Active	R	
High Sash Position Alarm Status	40012	0, 1	0: Inactive 1: Active	R	
Velocity Sensor Error Status	40013	0, 1	0: Inactive 1: Active	R	
Data Error Status	40014	0,1	0: Inactive 1: Active	R	
Setback Status	40015	0, 1	0: Inactive 1: Active	R	
Emergency Status	40016	0, 1	0: Inactive 1: Active	R	
Normal Face Velocity Setpoint	40021	60 to 1000	fpm	R/W	
Setback Face Velocity Setpoint	40022	60 to 1000	fpm	R/W	
Normal Low Face Velocity Alarm Setpoint	40023	5 to 980	fpm	R/W	
Normal High Face Velocity Alarm Setpoint	40024	80 to 1000	fpm	R/W	
Setback Low Face Velocity Alarm Setpoint	40025	5 to 945	fpm	R/W	
Setback High Face Velocity Alarm Setpoint	40026	50 to 1000	fpm	R/W	
Normal Flow Setpoint	40027	0 to 10000	cfm	R/W	
Setback Flow Setpoint	40028	0 to 10000	cfm	R/W	
Min Flow Setpoint	40029	0 to 10000	cfm	R/W	
Max Flow Setpoint	40030	0 to 10000	cfm	R/W	

**Modbus Communications** (continued)

Feature	Holding Register (Decimal)	Range	Unit	Read / Write	Notes
Normal Low Flow Alarm Setpoint	40031	0 to 10000	cfm	R/W	
Normal High Flow Alarm Setpoint	40032	0 to 10000	cfm	R/W	
Setback Low Flow Alarm Setpoint	40033	0 to 10000	cfm	R/W	
Setback High Flow Alarm Setpoint	40034	0 to 10000	cfm	R/W	
Min Damper Position	40035	0 to 100	%	R/W	
Max Damper Position	40036	0 to 100	%	R/W	
Setback Damper Position Setpoint	40037	0 to 100	%	R/W	
High Sash Position Alarm Setpoint	40038	0 to 105	%	R/W	
Units Value	40041	0, 1, 2	0: FPM, cfm 1: m/s & m <sup>3</sup> /h 2: m/s & l/s	R/W	For display only
Display Averaging	40042	0 to 7	0: 0.5 sec avg 1: 1 sec avg 2: 2 sec avg 3: 3 sec avg 4: 5 sec avg 5: 10 sec avg 6: 20 sec avg 7: 40 sec avg	R/W	
Emergency Mode	40043	0, 1	0: Exit Emergency Mode 1: Enter Emergency Mode	W	
Setback Mode	40044	0, 1	0: Exit Setback Mode 1: Enter Setback Mode	W	
Not Used	40045	N/A	N/A	R/W	Not used on standard configuration.
Not Used	40046	N/A	N/A	R/W	Not used on standard configuration.
Mute Timeout	40047	1 to 120	Minutes	R/W	0: Permanent Mute
Not Used	40048	N/A	N/A	R/W	Not used on standard configuration.
Not Used	40049	N/A	N/A	R/W	Not used on standard configuration.
Not Used	40050	N/A	N/A	R/W	Not used on standard configuration.
Alarm Reset	40051	0, 1	0: Unlatched 1: Latched	R/W	

**Modbus Communications** (continued)

Feature	Holding Register (Decimal)	Range	Unit	Read / Write	Notes
Not Used	40052	N/A	N/A	R	Not used on standard configuration.
Not Used	40053	N/A	N/A	R/W	Not used on standard configuration.
Setback Control Mode	40054	0, 1	0: Velocity Sidewall Sensor 1: Face Velocity Sash Position 2: Velocity Sidewall Sensor with Sash Position 3: Flow 4: Fixed Position	R/W	
Alarm Delay	40055	5-120	Seconds	R/W	

EXAMPLE of **06 Write Single Register** function format:

This example changes the normal low face velocity alarm set point to 60 ft/min.

**QUERY**

Field Name	(Hex)
Slave Address	01
Function	06
Starting Address Hi	00
Starting Address Lo	16
Data Value (High)	00
Data Value (Low)	3C
Error Check (CRC)	--

**RESPONSE**

Field Name	(Hex)
Slave Address	01
Function	06
Starting Address Hi	00
Starting Address Lo	16
Error Check (CRC)	--

EXAMPLE of **03 Read Holding Registers** function format:

This example reads the face velocity and current face velocity set point.

**QUERY**

Field Name	(Hex)
Slave Address	01
Function	03
Starting Address Hi	00
Starting Address Lo	00
No. Of Registers Hi	00
No. Of Registers Lo	02
Error Check (CRC)	--

**RESPONSE**

Field Name	(Hex)
Slave Address	01
Function	03
Byte Count	04
Data Hi	00
Data Lo	64 (100 ft/min)
Data Hi	00
Data Lo	64 (100 ft/min)
Error Check (CRC)	



## N2 Communications Description of Variables

### Description of Variables

Variable	Description
<b>NPT - Network Point Type</b>	Variables are defined as analog inputs, binary inputs, and analog outputs. Analog inputs are current control parameters and items that the controller is measuring. Binary inputs represent controller states. Analog outputs are the programmable set points for the Fume Hood Controller. These set points can be changed through the keypad or by over-writing the current set point.
<b>NPA - Network Point Address</b>	Address of the desired point.
<b>Change of Status (COS) - Face Velocity Analog Input</b>	The FHC50 has the ability to change control set points locally. The alarm set points need to be based on the controllers control set point (AI #2). The unit can be changed from Normal Mode to Setback Mode. For example the set point could go from 100 ft/min to 60 ft/min when the Setback key is pressed. If the COS alarm set points are not changed to accommodate you could get low alarm or low warning messages when the unit is working correctly. If these alarm points are set outside of the setback and main velocity set point values, incorrect alarm messages can be prevented.
<b>Override Analog Input Command</b>	The Damper Position Analog Input value can be set using the override command. This value will be reset to the correct item when the Override is released. There is not a time-out on the override command.  Other Analog Input values cannot be Overridden.
<b>Override Binary Input Command</b>	Overriding a 1 to the Setback or Emergency binary inputs enables the respective mode. To return the controller to normal mode from setback mode, press the Setback key on the controller, toggle the setback contact input, or release the override. To release controller from emergency state, override a 0 to the Emergency input, toggle the emergency contact input, or press either the emergency or reset key. Releasing the override will return the controller to the state it was in previous to the emergency, either Normal or Setback.  The alarm, data error, and sensor error variables can be overridden, but this will not affect the controller. Overriding the low alarm variable will result in a change of status, but will not put the controller into low alarm mode. The local alarm modes can only be controlled locally. Only override these variables for diagnostic purposes, and release them for normal operation.
<b>Binary Inputs, Sensor Error and Data Error</b>	Sensor Error and Data Error binary inputs are used to indicate if something has gone wrong with the controller. The Sensor Error is set when the sensor on the controller has a malfunction. This indicates that service should be done on the controller. Data Error indicates when some of the data stored on the device has been corrupted. The calibration and set point values should be checked on the controller.
<b>Override Analog Output Command</b>	The analog output variables can be overridden to change their values. The overridden value will be checked for validity. If invalid, the override command will be ignored, and the value will not change. The override flag will not be set when the value is ignored. The override command will be cleared when the variable is reset in the menus. The variable will not reset with the release command.

## Supported Commands

Command	Response
Request Device ID	Returns 0x10
Synchronize Time Command	Acknowledged. There is no internal clock to synchronize.
Poll without/With Ack Message	Any change of status is returned
Read Analog Input Command	Variable value
Read Binary Input Command	Variable value
Read Analog Output Command	Variable Value
Write Analog Input	Acknowledge
Write Binary Input	Acknowledge
Write Analog Output	Acknowledge
Override Analog Input Command	Acknowledge
Override Binary Input Command	Acknowledge
Override Analog Output Command	Acknowledge
Override Release Request	Acknowledge
Identify Device Type Command	Returns 0x10H

### NOTE

Poll Without/With Ack Message will need to be sent twice in order to receive all of the possible change of status variables.

## Variable Map

NPT	NPA	Feature	Unit
AI	1	Face Velocity	fpm, m/s
AI	2	Current Face Velocity Setpoint	fpm, m/s
AI	3	Flow Rate	cfm or L/s
AI	4	Current Flow Rate Setpoint	cfm or L/s
AI	5	Sash Position Percent	%
AI	6	Sash Open Area	ft <sup>2</sup> or m <sup>2</sup>
AI	7	Damper or Valve Position	%
AO	1	Normal Face Velocity Setpoint	fpm, m/s
AO	2	Setback Face Velocity Setpoint	fpm, m/s
AO	3	Min. Damper Position	%
AO	4	Max. Damper Position	%
AO	5	Normal Flow Setpoint	cfm or L/s
AO	6	Setback Flow Setpoint	cfm or L/s
AO	7	Minimum Flow Setpoint	cfm or L/s
AO	8	Maximum Flow Setpoint	cfm or L/s
AO	9	Normal Low Face Velocity Alarm Setpoint	fpm, m/s
AO	10	Normal High Face Velocity Alarm Setpoint	fpm, m/s
AO	11	Normal Low Flow Alarm Setpoint	cfm or L/s
AO	12	Normal High Flow Alarm Setpoint	cfm or L/s
AO	13	Setback Low Face Velocity Alarm Setpoint	fpm, m/s

<b>NPT</b>	<b>NPA</b>	<b>Feature</b>	<b>Unit</b>
<b>AO</b>	14	Setback High Face Velocity Alarm Setpoint	fpm, m/s
<b>AO</b>	15	Setback Low Flow Alarm Setpoint	cfm or L/s
<b>AO</b>	16	Setback High Flow Alarm Setpoint	cfm or L/s
<b>AO</b>	17	Setback Damper Position Setpoint	%
<b>AO</b>	18	High Sash Position Alarm Setpoint	%
<b>AO</b>	19	Units Value	0: English Units (fpm, cfm) 1: Metric Units (m/s, m <sup>3</sup> /h) 2: Metric Units (m/s, l/s)
<b>BI</b>	1	Low Velocity Alarm Status	0: Inactive 1: Active
<b>BI</b>	2	High Velocity Alarm Status	0: Inactive 1: Active
<b>BI</b>	3	Low Flow Alarm Status	0: Inactive 1: Active
<b>BI</b>	4	High Flow Alarm Status	0: Inactive 1: Active
<b>BI</b>	5	High Sash Position Alarm Status	0: Inactive 1: Active
<b>BI</b>	6	Velocity Sensor Error Status	0: Inactive 1: Active
<b>BI</b>	7	Data Error Status	0: Inactive 1: Active
<b>BI</b>	8	Setback Status	0: Inactive 1: Active
<b>BI</b>	9	Emergency Status	0: Inactive 1: Active

\* Not available on standard Model FHC50s.

\*\* The units of the variables are based on the units variable. When the units variable is set to 0 the values are in English form. When the units variable is set to 1 or 2 the units are metric. English is the default units.

## LonWorks® Object

### Node Object Network Variables

SNVT Number	Bit	Description	SNVT Name	SNVT Type
4			nviRequest	SNVT_obj_request
5			nviSetTime	SNVT_time_stamp
6			nvoStatus	SNVT_obj_status
7			nvoAlarm	SNVT_alarm
	1	AL_LOW_LMT_1 Low Face Velocity Alarm		
	2	AL_HIGH_LMT_1 High Face Velocity Alarm		
	3	AL_LOW_LMT_2 Low Exhaust Flow Alarm		
	4	AL_HIGH_LMT_2 High Exhaust Flow Alarm		
	5	AL_ALM_CONDITION Sash Alarm		

### Fume Hood Controller Object Network Variables

SNVT Number	Bit	Description	SNVT Name	SNVT Type
15		Setback Mode	nviControlMode	SNVT_occupancy
16		Emergency Mode	nviEmergency	SNVT_hvac_emerg
17		Remote Control Override	nviOverrideOn	SNVT_switch
18		Face Velocity	nvoFaceVelocity	SNVT_speed_mil
19		Flow Rate.	nvoExhaust Flow	SNVT_flow
20		Damper or Valve Position	nvoControlPos	SNVT_lev_percent
21		Sash Position Percent.	nvoSashPosPcnt	SNVT_lev_percent
22		Sash Open Area.	nvoSashOpenArea	SNVT_area
23		Status	nvoUnitState	SNVT_state
	0	Setback Status		
	1	Low Velocity Alarm Status		
	2	High Velocity Alarm Status		
	3	Low Flow Alarm Status		
	4	High Flow Alarm Status		
	5	High Sash Position Alarm Status		
	6	Velocity Sensor Error Status		
	7	Data Error Status		
	8	Emergency Status		
	9	Remote Control Override Status		
24		Normal Face Velocity Setpoint	nvoNormFVSetp	SNVT_speed_mil

<b>SNVT Number</b>	<b>Bit</b>	<b>Description</b>	<b>SNVT Name</b>	<b>SNVT Type</b>
25		Setback Face Velocity Setpoint	<b>nvoSetbFVSetp</b>	<b>SNVT_speed_mil</b>
26		Normal Low Face Velocity Alarm Setpoint	<b>nvoNormLoFVAlmSetp</b>	<b>SNVT_speed_mil</b>
27		Normal High Face Velocity Alarm Setpoint	<b>nvoNormHiFVAlmSetp</b>	<b>SNVT_speed_mil</b>
28		Setback Low Face Velocity Alarm Setpoint	<b>nvoSbLoFVAlmSetp</b>	<b>SNVT_speed_mil</b>
29		Setback High Face Velocity Alarm Setpoint	<b>nvoSbHiFVAlmSetp</b>	<b>SNVT_speed_mil</b>
30		Normal Flow Setpoint	<b>nvoNormFlowSetp</b>	<b>SNVT_flow</b>
31		Setback Flow Setpoint	<b>nvoSetbFlowSetp</b>	<b>SNVT_flow</b>
32		Normal Low Flow Alarm Setpoint	<b>nvoNmLoFloAlSetp</b>	<b>SNVT_flow</b>
33		Normal High Flow Alarm Setpoint	<b>nvoNmHiFloAlSetp</b>	<b>SNVT_flow</b>
34		Setback Low Flow Alarm Setpoint	<b>nvoSbLoFloAlSetp</b>	<b>SNVT_flow</b>
35		Setback High Flow Alarm Setpoint	<b>nvoSbHiFloAlSetp</b>	<b>SNVT_flow</b>
36		Minimum Flow Setpoint	<b>nvoMinFlowSetp</b>	<b>SNVT_flow</b>
37		Maximum Flow Setpoint	<b>nvoMaxFlowSetp</b>	<b>SNVT_flow</b>
38		Minimum Damper Setpoint	<b>nvoMinDampSp</b>	<b>SNVT_lev_percent</b>
39		Maximum Damper Setpoint	<b>nvoMaxDampSp</b>	<b>SNVT_lev_percent</b>
40		Setback Damper Position Setpoint	<b>nvoSetbCtrlPos</b>	<b>SNVT_lev_cont</b>
41		High Sash Position Alarm Setpoint	<b>nvoHiSashAlmPos</b>	<b>SNVT_lev_cont</b>
		nciMaxSendTime		
		nciMinSendTime		
		nciSndDeltaFlow		
		nciSndDeltaSpeed		
		nciSndDeltaPos		

## Description of LON SNVTs

SNVT	Command Supported	Action
nviEmergency:	EMERG_NORMAL EMERG_PURGE	Sets NORMAL mode Sets EMERGENCY mode

**NOTE:** All other commands set NORMAL mode

SNVT	Command Supported	Action
nviControlMode:	OC_OCCUPIED OC_STANDBY OC_UNOCCUPIED	Sets NORMAL mode Sets SETBACK mode Sets SETBACK mode

**NOTE:** All other commands set NORMAL mode

SNVT	Command Supported	Action
nviRequest object_request	CLEAR_ALARM	Clears alarm (See SNVT nvoAlarm)

SNVT	Value Sent	Action
nviOverrideOn	x.x 1 x.x 0	Moves damper to override position Exit Override mode x.x is damper position between 0.0 to 100.0

---

# FHC50 BACnet® MS/TP Protocol Implementation Conformance Statement

**Date:** April 7, 2010

**Vendor Name:** TSI Inc.

**Product Name:** Fume Hood Controller

**Product Model Number:** FHC50-BAC

**Applications Software Version:** 1.0

**Firmware Revision:** 1.0

**BACnet Protocol Revision:** 2

## Product Description:

TSI®'s Fume Hood Fume Hood Controller provides a closed-loop VAV control system for proper lab hood containment. controller assures safety by responding quickly during sash movement, or to disturbances within the sash plane, to maintain a constant face velocity and contain hazardous chemicals. The controller provides opportunities for energy savings, lower fan brake horsepower, smaller chillers and lower duct work cost by reducing the volume of air exhausted from a hood when the sash is not fully open. This model controller is capable of acting as a stand-alone device or as part of a building automation system via BACnet® MS/TP protocol.

## BACnet Standardized Device Profile (Annex L):

- BACnet Operator Workstation (B-OWS)
- BACnet Building Controller (B-BC)
- BACnet Advanced Application Controller (B-AAC)
- BACnet Application Specific Controller (B-ASC)
- BACnet Smart Sensor (B-SS)
- BACnet Smart Actuator (B-SA)

## List all BACnet Interoperability Building Blocks Supported (Annex K):

DS-RP-B	DM-DDB-B
DS-WP-B	DM-DOB-B
DS-RPM-B	DM-DCC-B

## Segmentation Capability:

Segmented requests not supported

Segmented responses not supported

**Standard Object Types Supported:**

	<b>Dynamically Createable</b>	<b>Dynamically Deletable</b>	<b>Optional Properties Supported</b>	<b>Writable Properties (Data Type)</b>
<b>Analog Input</b>	No	No		
<b>Analog Value</b>	No	No		Present_Value (Real)
<b>Binary Input</b>	No	No	Active_Text, Inactive_Text	
<b>Binary Value</b>	No	No	Active_Text, Inactive_Text	Present_Value (Enumerated)
<b>Multi-state Input</b>	No	No	State_Text	
<b>Multi-state Value</b>	No	No	State_Text	Present_Value (Unsigned Int)
<b>Device Object</b>	No	No		Object Name (Char String) Max Master (Unsigned Int)

**Data Link Layer Options:**

- BACnet IP, (Annex J)
- BACnet IP, (Annex J), Foreign Device
- ISO 8802-3, Ethernet (Clause 7)
- ANSI/ATA 878.1, 2.5 Mb. ARCNET (Clause 8)
- ANSI/ATA 878.1, RS-485 ARCNET (Clause 8), baud rate(s)
- MS/TP master (Clause 9), baud rate(s): 76.8k 38.4k, 19.2k, 9600 bps
- MS/TP slave (Clause 9), baud rate(s):
- Point-To-Point, EIA 232 (Clause 10), baud rate(s):
- Point-To-Point, modem, (Clause 10), baud rate(s):
- LonTalk, (Clause 11), medium:
- Other:

**Device Address Binding:**

Is static device binding supported? (This is currently necessary for two-way communication with MS/TP slaves and certain other devices.)  Yes  No

**Networking Options:**

- Router, Clause 6 - List all routing configurations, e.g., ARCNET-Ethernet, Ethernet-MS/TP, etc.
- Annex H, BACnet Tunneling Router over IP
- BACnet/IP Broadcast Management Device (BBMD)

**Character Sets Supported:**

Indicating support for multiple character sets does not imply that they can all be supported simultaneously.

- ANSI X3.4
- IBM®/Microsoft® DBCS
- ISO 8859-1
- ISO 10646 (UCS-2)
- ISO 10646 (UCS-4)
- JIS C 6226

**If this product is a communication gateway, describe the types of non-BACnet® equipment/networks(s) that the gateway supports:**

Not Applicable



## BACnet® MS/TP Object Set

Feature	Object Type	Device Instance	Units	Range	Read/Write	Notes
Face Velocity	Analog Input	1	fpm	0 to 1000	R	
			m/s	0 to 5.08		
Flow Rate	Analog Input	2	cfm	0 to 10000	R	
			m <sup>3</sup> /h	0 to 16990		
			l/s	0 to 4719		
Damper or Valve Position	Analog Input	3	%	0 to 100	R	
Sash Position Percent	Analog Input	4	%	0 to 100	R	
Sash Open Area	Analog Input	5	ft <sup>2</sup>	0 to 1000	R	
			m <sup>2</sup>	0 to 93		
MAC Address	Analog Value	1	-	1 to 127	R/W	Communications will be lost until front-end updated with new MAC Address
MAC ID** (1 <sup>st</sup> 4 digits)	Analog Value	2	N/A	1 to 4,194	R/W	
Normal Face Velocity Setpoint	Analog Value	3	fpm	0, 60 to 1000	R/W	
			m/s	0, 0.03 to 5.08		
Setback Face Velocity Setpoint	Analog Value	4	fpm	0, 60 to 1000	R/W	
			m/s	0, 0.03 to 5.08		
Normal Low Face Velocity Alarm Setpoint	Analog Value	5	fpm	0, 5 to 980	R/W	
			m/s	0, 0.03 to 4.98		
Normal High Face Velocity Alarm Setpoint	Analog Value	6	fpm	0, 80 to 1000	R/W	
			m/s	0, 0.42 to 5.08		
Setback Low Face Velocity Alarm Setpoint	Analog Value	7	fpm	0, 5 to 980	R/W	
			m/s	0, 0.03 to 4.98		
Setback High Face Velocity Alarm Setpoint	Analog Value	8	fpm	0, 80 to 1000	R/W	
			m/s	0, 0.42 to 5.08		
Normal Flow Setpoint	Analog Value	9	cfm	0 to 10000	R/W	
			m <sup>3</sup> /h	0 to 16990		
			l/s	0 to 4719		
Setback Flow Setpoint	Analog Value	10	cfm	0 to 10000	R/W	
			m <sup>3</sup> /h	0 to 16990		
			l/s	0 to 4719		
Normal Low Flow Alarm Setpoint	Analog Value	11	cfm	0 to 10000	R/W	
			m <sup>3</sup> /h	0 to 16990		
			l/s	0 to 4719		
Normal High Flow Alarm Setpoint	Analog Value	12	cfm	0 to 10000	R/W	
			m <sup>3</sup> /h	0 to 16990		
			l/s	0 to 4719		

Feature	Object Type	Device Instance	Units	Range	Read/Write	Notes
Setback Low Flow Alarm Setpoint	Analog Value	13	cfm	0 to 10000	R/W	
			m <sup>3</sup> /h	0 to 16990		
			l/s	0 to 4719		
Setback High Flow Alarm Setpoint	Analog Value	14	cfm	0 to 10000	R/W	
			m <sup>3</sup> /h	0 to 16990		
			l/s	0 to 4719		
Min. Damper Position	Analog Value	15	%	0 to 100	R/W	
Max. Damper Position	Analog Value	16	%	0 to 100	R/W	
Minimum Flow Setpoint	Analog Value	17	cfm	0 to 10000	R/W	
			m <sup>3</sup> /h	0 to 16990		
			l/s	0 to 4719		
Maximum Flow Setpoint	Analog Value	18	cfm	0 to 10000	R/W	
			m <sup>3</sup> /h	0 to 16990		
			l/s	0 to 4719		
Setback Damper Position Setpoint	Analog Value	19	%	0 to 100	R/W	
High Sash Position Alarm Setpoint	Analog Value	20	%	0, 10 to 105	R/W	
MAC ID** (Last 3 digits)	Analog Value	21	N/A	1 to 999	R/W	Communications will be lost until front-end updated with new MAC Address
Low Velocity Alarm Status	Binary Input	1	0: Inactive 1: Active	0;1	R	
High Velocity Alarm Status	Binary Input	2	0: Inactive 1: Active	0;1	R	
Low Flow Alarm Status	Binary Input	3	0: Inactive 1: Active	0;1	R	
High Flow Alarm Status	Binary Input	4	0: Inactive 1: Active	0;1	R	
High Sash Position Alarm Status	Binary Input	5	0: Inactive 1: Active	0;1	R	
Velocity Sensor Error Status	Binary Input	6	0: Inactive 1: Active	0;1	R	
Data Error Status	Binary Input	7	0: Inactive 1: Active	0;1	R	
Setback Status	Binary Input	8	0: Inactive 1: Active	0;1	R	
Emergency Status	Binary Input	9	0: Inactive 1: Active	0;1	R	
Auto Baud	Multi-State	1	0: No Action 1 Set Auto Baud	0;1	R/W	Controller will reset variable to 0 after setting baud rate.

Feature	Object Type	Device Instance	Units	Range	Read/Write	Notes
Emergency Mode	Multi-State	2	1: Exit Emergency Mode 2: Enter Emergency Mode 3: Normal	1; 2; 3	R/W	
Setback Mode	Multi-State	3	1: Exit Setback Mode 2: Enter Setback Mode 3: Normal	1; 2; 3	R/W	
Units Value	Multi-State	4	1: fpm and cfm 2: m/s and m <sup>3</sup> /h 3: m/s & l/s	1; 2; 3	R/W	

\* The units are based on the value of the Units Value object. When the Units Value is set to 1 the units are in English form. When the Units Value is set to 2 or 3 the units are metric. English is the default value.

\*\* The device index is the 1<sup>st</sup> 4 digits of the MAC ID (AV 2) multiplied by 1000 plus the Last 3 Digits of the MAC ID (AV 21). For example, if the device index is 4,194,302 then the 1<sup>st</sup> 4 digits of the MAC ID (AV 2) will be 4,194 and the Last 3 Digits of the MAC ID (AV 21) will be 302.

*(This page intentionally left blank)*

## Appendix C

---

### Wiring Information

#### Back Panel Wiring

PIN #	Input/Output/ Communication	Description
1, 2	Input	24 VAC to power Digital Interface Module (DIM).
3, 4	Output	0 to 10 VDC fume hood exhaust control signal. See menu item <a href="#">CONTROL SIG</a> Not used on fume hood monitor.
5, 6	Communications	LONworks®/BACnet® MS/TP communications (optional)
7, 8, 9	Output	RS-485 communications to building management system (Modbus® or N2)
10, 11	Output	0 to 10 VDC/4 to 20 mA analog output signal. See menu item <a href="#">ANALOG OUT TYPE</a> .
12, 13	Output	Alarm Relay B. See menu items <a href="#">RELAYS OUT</a> and <a href="#">RELAY SEL B</a> .
14, 15	Output	Alarm Relay A. Low face velocity/flow alarm. See menu item <a href="#">RELAYS OUT</a> .
16, 17	Input	Non-powered input #1. Accepts sash sensor, sash switch, emergency switch or night setback switch. See menu item <a href="#">INPUT SEL 1</a> .
18, 19	Input	Non-powered input #2. Accepts sash switch, emergency switch or night setback switch. See menu item <a href="#">INPUT SEL 2</a> .
20, 21	Input	Non-powered input #3. Accepts sash switch, emergency switch or night setback switch. See menu item <a href="#">INPUT SEL 3</a> .
22, 23	Input	0 to 10 VDC Flow input. See menu item <a href="#">FLOW DEVICE</a> .

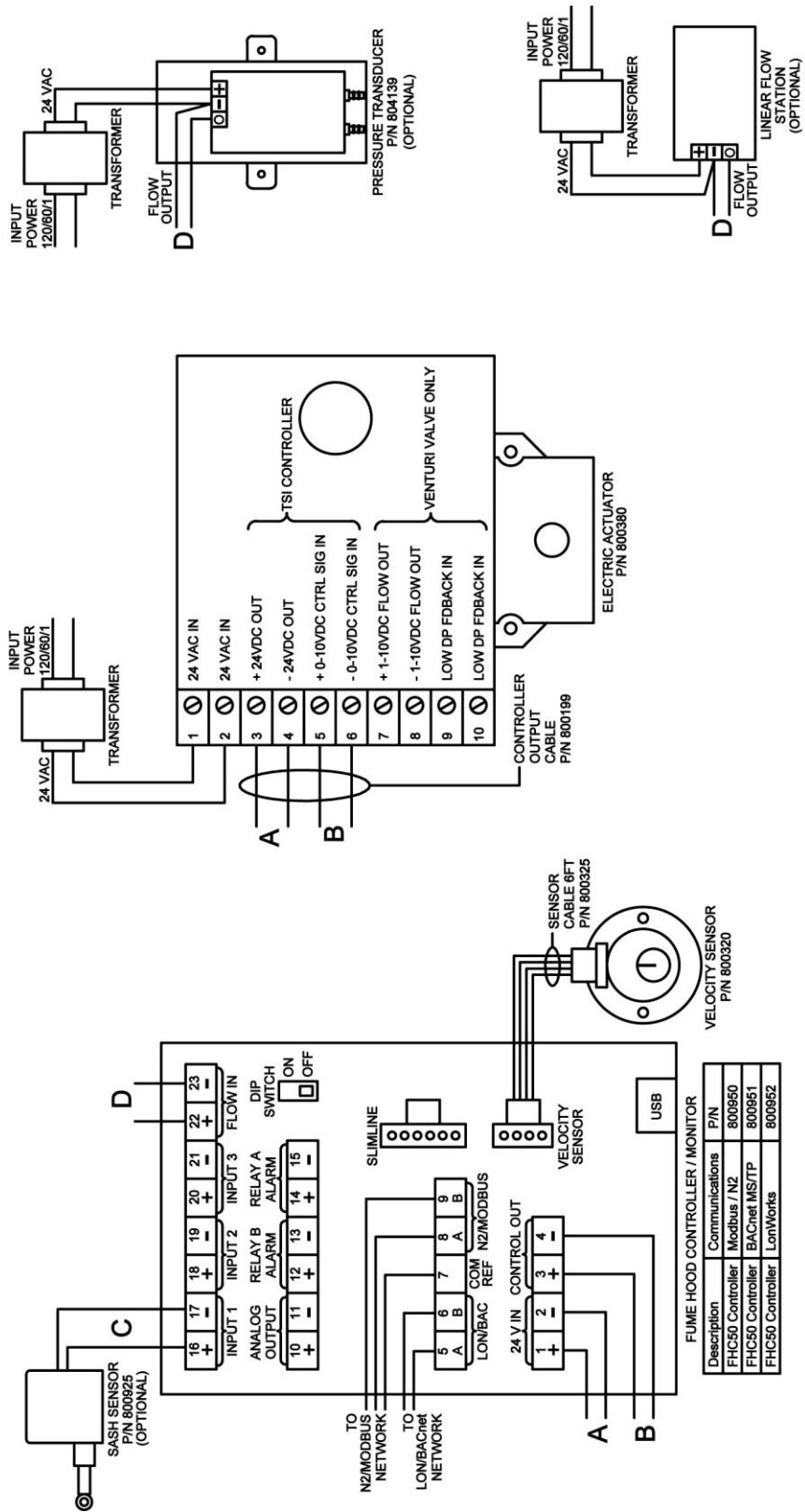

Figure 7: Wiring Diagram—Model FHC50-01 Controller

- Transformers not included.
- Maintain polarity on all connections.
- FHC50 Voltage Input Range (pins 1 and 2): 24VAC 50/60Hz, or 15-40VDC.
- FHC50 and Electric Actuator 800380 have isolated power inputs and can share transformers with other devices.
- FHC50 and Electric Actuator 800380 combined require 50VA transformer.
- The FHC50 DIP switch must be in OFF position.
- USB Port used for TSI Fume Hood Configuration Software.

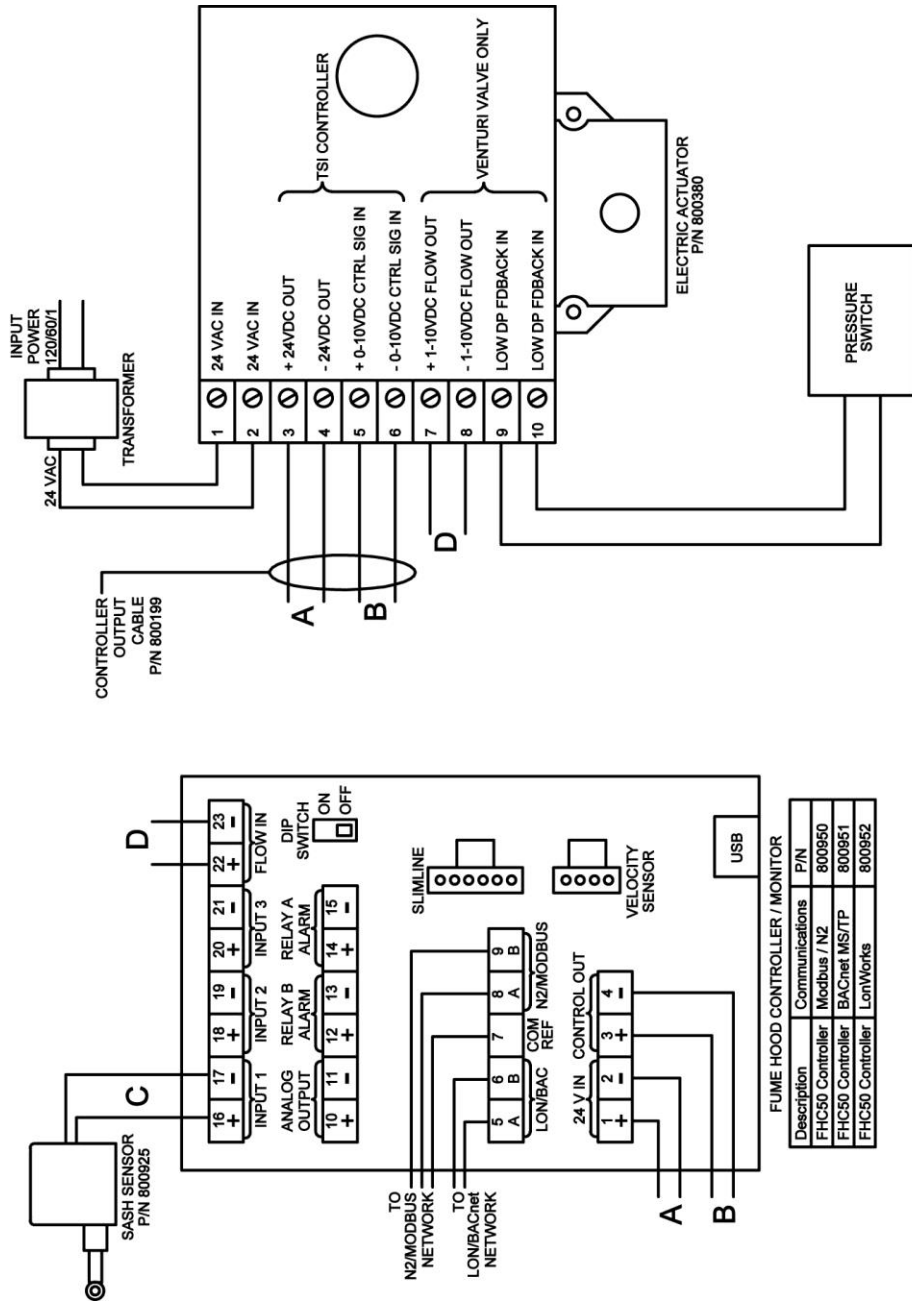

Figure 8: Wiring Diagram—Model FHC50-02 Controller

- Transformers not included.
- Maintain polarity on all connections.
- FHC50 Voltage Input Range (pins 1 and 2): 24VAC 50/60Hz, or 15-40VDC.
- FHC50 and Electric Actuator 800380 have isolated power inputs and can share transformers with other devices.
- FHC50 and Electric Actuator 800380 combined require 50VA transformer.
- The FHC50 DIP switch must be in OFF position.
- USB Port used for TSI Fume Hood Configuration Software.

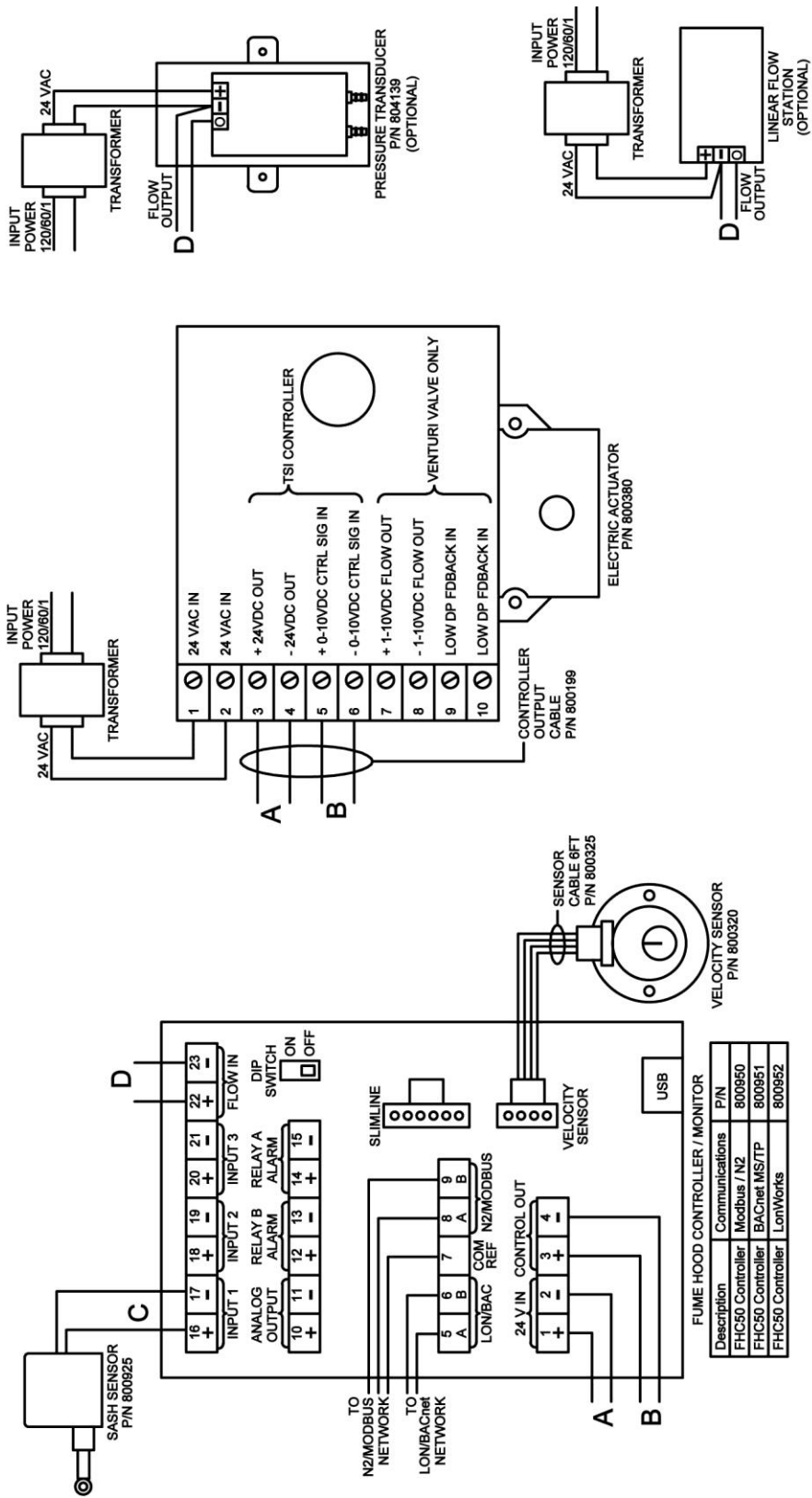

Figure 9: Wiring Diagram—Model FHC50-03 Controller

- Transformers not included.
- Maintain polarity on all connections.
- FHC50 Voltage Input Range (pins 1 and 2): 24VAC 50/60Hz, or 15-40VDC.
- FHC50 and Electric Actuator 800380 have isolated power inputs and can share transformers with other devices.
- FHC50 and Electric Actuator 800380 combined require 50VA transformer.
- The FHC50 DIP switch must be in OFF position.
- USB Port used for TSI Fume Hood Configuration Software.



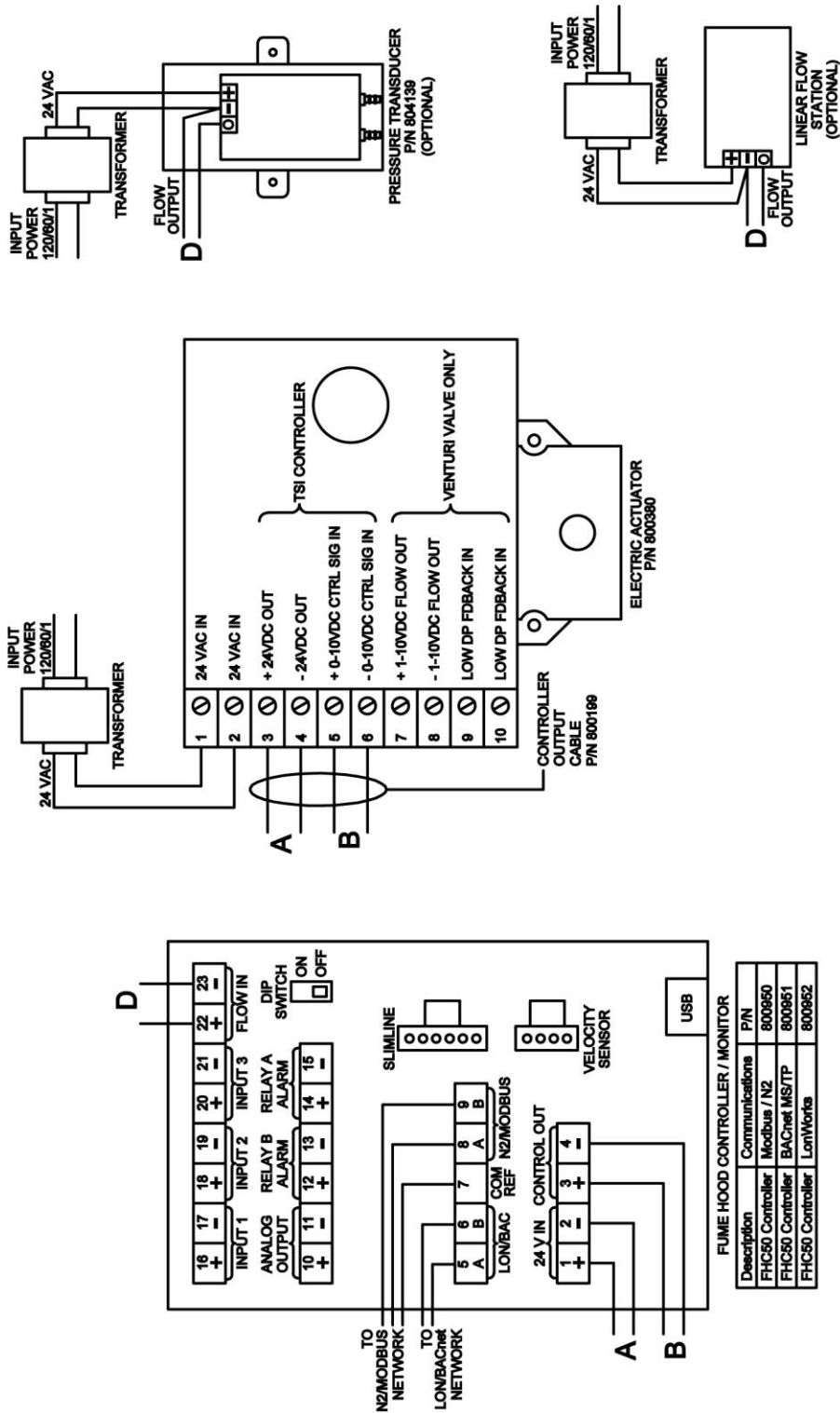
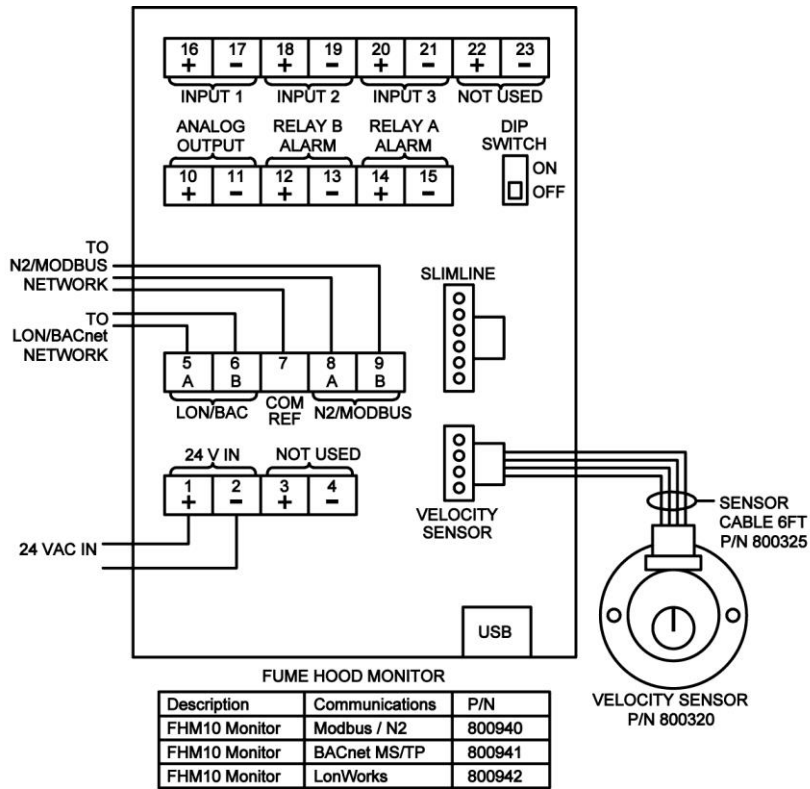

Figure 10: Wiring Diagram—Model FHC50-04 Controller

- Transformers not included.
- Maintain polarity on all connections.
- FHC50 Voltage Input Range (pins 1 and 2): 24VAC 50/60Hz, or 15-40VDC.
- FHC50 and Electric Actuator 800380 have isolated power inputs and can share transformers with other devices.
- FHC50 and Electric Actuator 800380 combined require 50VA transformer.
- The FHC50 DIP switch must be in OFF position.
- USB Port used for TSI Fume Hood Configuration Software.



- Transformers not included.
- Maintain polarity on all connections.
- FHM10 Voltage Input Range (pins 1 and 2): 24VAC 50/60Hz, or 15-40VDC, 5W maximum.
- FHM10 has isolated power input and can share transformer with other devices.
- The FHM10 DIP switch must be in OFF position.
- For FHM10 Monitor, pins 3 + 4 and electric actuator are not used.
- USB port used for TSI Fume Hood Configuration Software.

**Figure 11: Model FHM10-01 Monitor Wiring**

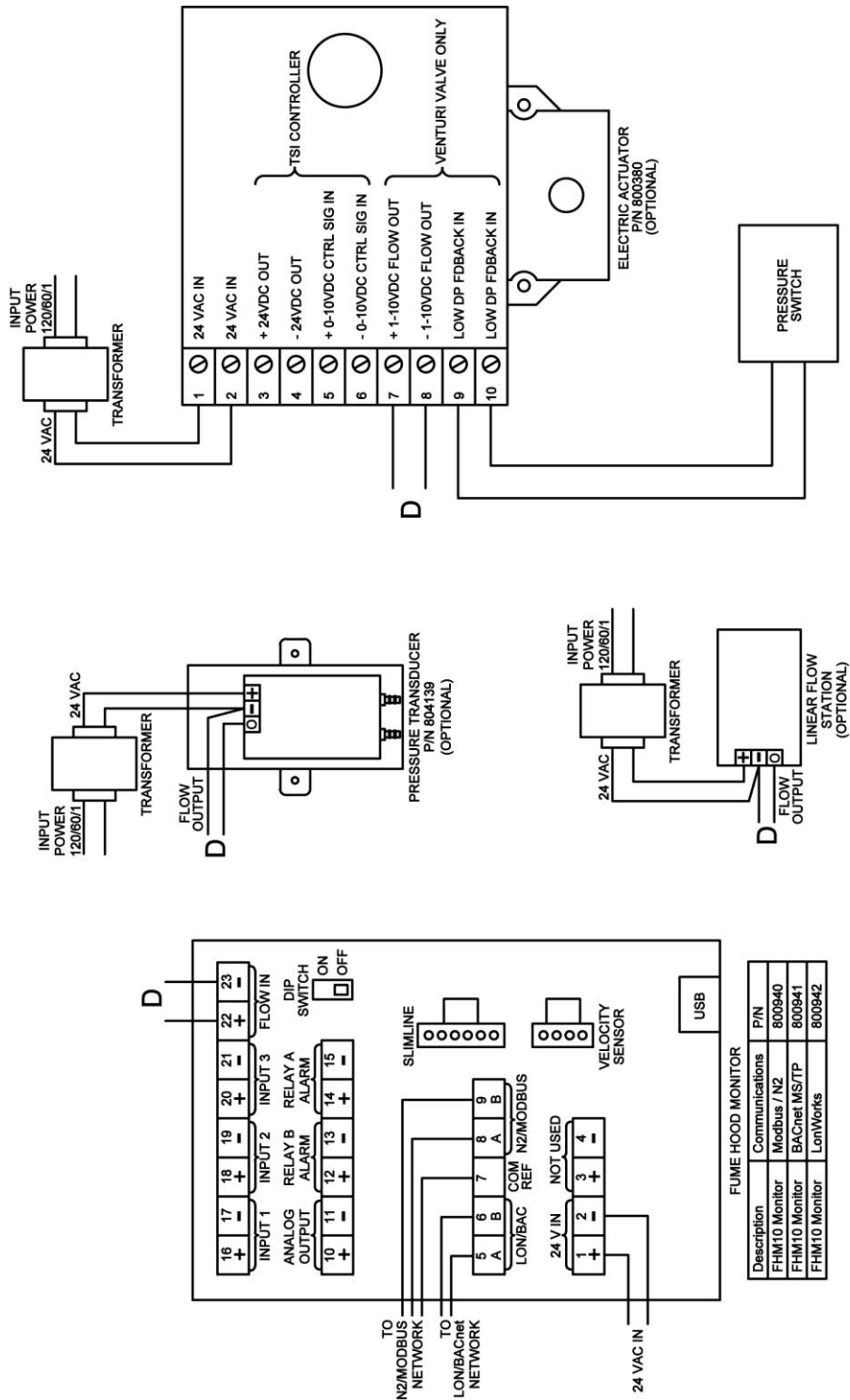

Figure 12: Model FHM10-02 Monitor Wiring

- Transformers not included.
- Maintain polarity on all connections.
- FHM10 Voltage Input Range (pins 1 and 2): 24VAC 50/60Hz, or 15-40VDC.
- FHM10 and Electric Actuator 800380 have isolated power inputs and can share transformers with other devices.
- FHM10 and Electric Actuator 800380 combined require 50VA transformer.
- The FHM10 DIP switch must be in OFF position.
- For FHM10 Monitor, pins 3 + 4 and electric actuator are not used.
- USB port used with TSI Fume Hood Configuration Software.

*(This page intentionally left blank)*

## Appendix D

---

### Access Codes / Password

The Model FHM10 Fume Hood Monitor and FHC50 Fume Hood Controller may prompt the user to enter an access code to enter the menu system. The access code screen is shown below in Figure 13. To enter the access code, use the:

- Quick keys as left and right arrows.
- ▼/▲ keys as up and down arrows.
- ↵key selects the currently highlighted character.
- **ESC** key exits the access code entry screen.

The access code is **2887**.

Entering the access code enables access to the menu system for a 15-minute period.

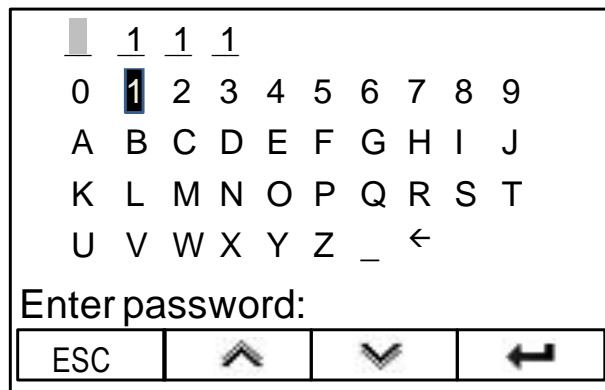

Figure 13. Access Code Screen

*(This page intentionally left blank)*





UNDERSTANDING, ACCELERATED

**TSI Incorporated** – Visit our website [www.tsi.com](http://www.tsi.com) for more information.

<b>USA</b>	<b>Tel:</b> +1 800 680 1220	<b>India</b>	<b>Tel:</b> +91 80 67877200
<b>UK</b>	<b>Tel:</b> +44 149 4 459200	<b>China</b>	<b>Tel:</b> +86 10 8219 7688
<b>France</b>	<b>Tel:</b> +33 1 41 19 21 99	<b>Singapore</b>	<b>Tel:</b> +65 6595 6388
<b>Germany</b>	<b>Tel:</b> +49 241 523030		

P/N 6003830 Rev. H      ©2022 TSI Incorporated      Printed in U.S.A.

