

INSTRUCTIONS FOR THE 1500 SERIES MICROPROCESSOR BASED TEMPERATURE CONTROL



LOVE CONTROLS

a Division of Dwyer Instruments, Incorporated
PO Box 338 ○ Michigan City, IN 46360
(800) 828-4588 ○ (219) 879-8000 ○ FAX (219) 872-9057
www.love-controls.com

949-1185 Rev. 5

TABLE OF CONTENTS

INSTALLATION.....	3
WIRING.....	4
FRONT PANEL KEY FUNCTIONS.....	5
MENU SELECTIONS.....	7
PRIMARY MENU.....	7
SECONDARY MENU.....	8
SECURE MENU.....	10
ALARM TYPE AND ACTION.....	11
SPECIFICATIONS.....	13
DIAGNOSTIC ERROR MESSAGES.....	14
INPUT RANGES.....	16
DIMENSIONS.....	16



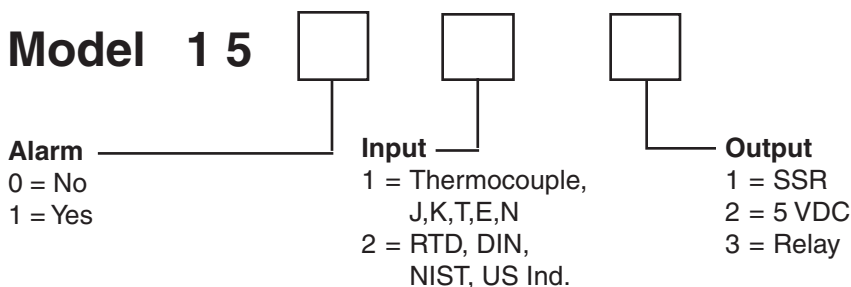

MODEL IDENTIFICATION





GETTING STARTED

1. Install the control as described on page 3.
2. Wire your control following the instructions on page 4 and drawing on page 5.
3. Most controls do not need many (if any) program changes to work on your process. For best results if programming changes are necessary, make all the necessary changes in the Secure Menu (page 10) before making changes to the Secondary Menu (page 8). If error messages occur, check the Diagnostic Error Messages on page 14 for help.





Take the example of a Model 15011 that comes from the factory programmed for type J thermocouples. Suppose for this example you wish to change the input to type K and limit the set point range between 0° and 1000° C.

First, enter the Secure menu by pressing and holding   UP ARROW and ENTER (see page 10). Press the  INDEX key until the display shows in^{ρ} and press the  DOWN ARROW until the display shows ζR . Don't forget to press the  ENTER key to retain your setting.

Next, press the  INDEX key to display $F-\zeta$. Press the  DOWN ARROW until the display shows ζ . Press  ENTER.

Next, press the  INDEX key until $S^{\rho L}$ is displayed (pass the $d^{\rho L}$ and $in^{\rho L}$ selections). Press the  UP ARROW until the display shows ζ . Press  ENTER.

Finally, press  INDEX key to display $S^{\rho H}$. Press the  DOWN ARROW until the display shows 000 . Press  ENTER.

The necessary program changes are now complete. After 30 seconds the display will switch back to the temperature reading. If you want to return faster, press the   UP ARROW and ENTER keys (at the same time) and then press the   DOWN ARROW and INDEX keys (again at the same time). This will 'back out' of the menu and immediately display the temperature reading.

INSTALLATION

Mount the instrument in a location that will not be subject to excessive temperature, shock, or vibration. All models are designed for mounting in an enclosed panel.

Select the position desired for the instrument on the panel. If more than one instrument is required, maintain the minimum of spacing requirements as shown on the drawing below. Closer spacing will structurally weaken the panel, and invalidate the IP66, UL type 4 rating of the panel.

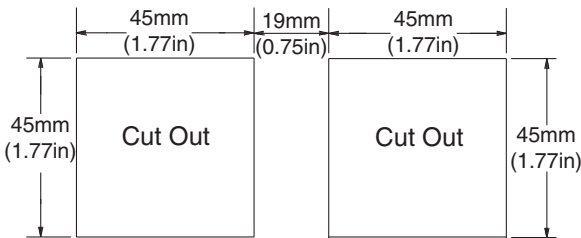

All Tolerances are -0.00 +0.60mm (-0.000 +0.020 in.)

Prepare the panel by cutting and deburring the required opening.

From the front of the panel, slide the housing through the cut out. The housing gasket should be against the housing flange before installing.

From the rear of the panel slide the mounting collar over the housing. Hold the housing with one hand and using the other hand, push the collar evenly against the panel until the spring loops are slightly compressed. The ratchets will hold the mounting collar and housing in place.

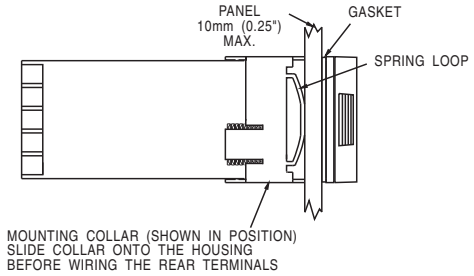

CAUTION: It is not necessary to remove the instrument chassis from the housing for installation. If the instrument chassis is removed from the housing, you must follow industry standard practice for control and protection against Electro-Static Discharge (ESD). Failure to exercise good ESD practices may cause damage to the instrument.

WIRING

Do not run thermocouple or other class 2 wiring in the same conduit as power leads. Use only the type of thermocouple or RTD probe for which the control has been programmed. Maintain separation between wiring of sensor, auxiliary in or out, and other wiring. See the "Secure Menu" for input selection.

For thermocouple input always use extension leads of the same type designated for your thermocouple.

For supply connections use No. 16 AWG or larger wires rated for at least 75°C. Use copper conductors only. All line voltage output circuits must have a common disconnect and be connected to the same pole of the disconnect.

Input wiring for thermocouple and RTD; and output wiring for 5 VDC is rated CLASS 2.

Control wiring is as shown opposite.

Note: The Relay and SSR outputs do not source power. They act only as switches. Power must be provided to the output for proper operation. This allows the control and load to operate on different potentials if necessary.

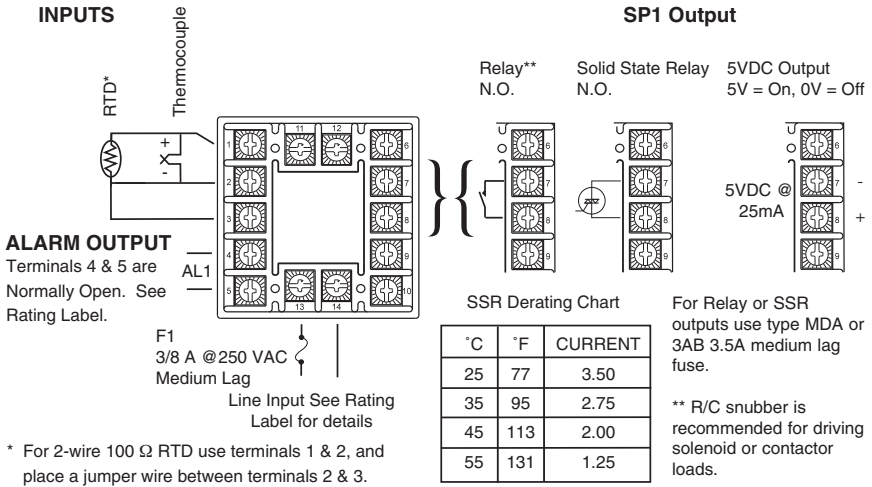

FRONT PANEL KEY FUNCTIONS

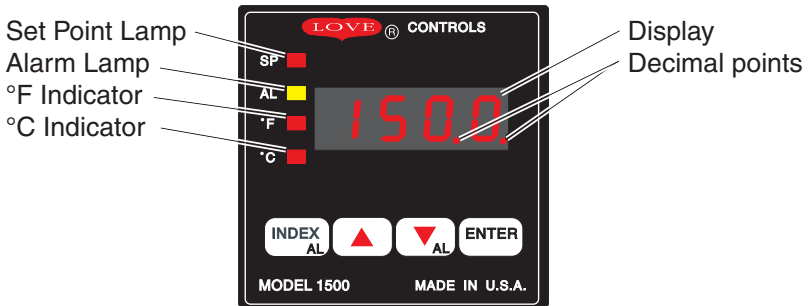



The °F/°C indicator will flash while Self-Tune is operating.
 The rightmost decimal point flashes while the ramping function is active.

The 1500 Series controls have one display. The display must occasionally switch to show a complete message or menu item and its value. The normal display shows just the temperature and does not switch. While showing a menu item, the display will alternate between the menu item and the item value. If the ▲ UP ARROW, ▼ DOWN ARROW, or ENTER ENTER keys are pressed, the display immediately switches to display the item value.

Key functions are as follows:

INDEX: Pressing the INDEX key advances the display to the next menu item. May also be used in conjunction with other keys as noted below.

 **UP ARROW:** Increments a value, changes a menu item, or selects the item to ON. The maximum value obtainable is 9999 or 999.9.

 **DOWN ARROW:** Decrements a value, changes a menu item, or selects the item to OFF. The minimum value obtainable is -1999 or -199.9.

 **ENTER:** Pressing ENTER stores the value or the item changed. If not pressed, the previously stored value or item will be retained. The display will flash once when ENTER is pressed.

 **UP ARROW & ENTER:** Pressing these keys simultaneously brings up the **secondary menu** starting at the alarm, tune, or cycle item (depending on programming). Pressing these keys for 5 seconds will bring up the **secure menu**.

 **INDEX & DOWN ARROW:** Pressing these keys simultaneously will allow backing up one menu item, or if at the first menu item they will cause the display to return to the **primary menu**. If an alarm condition has occurred, these keys may be used to reset the alarm.

 **INDEX & ENTER:** Pressing these keys simultaneously and holding them for 5 seconds allows recovery from the various error messages. The following menu items will be reset:

AL INH: Alarm inhibit *OPEN INP:* Thermocouple error message
RTD INP: RTD error message *CHEC CAL:* Check calibration error message



Correct the problems associated with the above conditions first before using these reset keys. More than one error could be present. Caution is advised since several items are reset at one time.

While in the Primary or Secondary menu, if no key is pressed for a period of 30 seconds, the display will return to the HOME position displaying the temperature value. The time is increased to 1 minute when in the Secure menu.

NOTE: To move to the primary menu quickly from any other menu, press the  UP ARROW & ENTER keys followed by pressing the

 INDEX & DOWN ARROW keys.

SECURITY LEVEL SELECTION





Four levels of security are provided. The display shows the current security level. To change security levels change the password value using the  UP ARROW &  DOWN ARROW keys and pressing the  ENTER key. Refer to the password table below for the correct value to enter for the security level desired. The *SECr* menu item security level may be viewed or changed at any time regardless of the present security level. The password values shown in the table cannot be altered, so retain a copy of this page for future reference. This will be the only reference made to password values in this instruction book.

PASSWORD TABLE

Menu	Security Level Status	Displayed Value When Viewed	Password Value To Enter
Primary Secondary Secure	Locked Locked Locked	1	110
Primary Secondary Secure	Unlocked Locked Locked	2	101
Primary Secondary Secure	Unlocked Unlocked Locked	3	011
Primary Secondary Secure	Unlocked Unlocked Unlocked	4	111

MENU SELECTIONS

PRIMARY MENU

Press  INDEX to advance to the next menu item. Press  UP ARROW &  DOWN ARROW keys to change the value in the display. Press  ENTER to retain the value.

SP Set Point Adjust, Control Point.

SECONDARY MENU

Press  **ENTER** **UP ARROW & ENTER**. Press **INDEX**  to advance to the next menu item. Press  **UP ARROW &**  **DOWN ARROW** keys to change the value in the display. Press  **ENTER** to retain the value.

ALLo Alarm Low: The Low Alarm point is usually set below the Set Point.

ALHi Alarm High: The High Alarm Point is usually set above the Set Point.

CY Cycle Rate and output selection: Select *OnOff*, 1, 2 to 80 seconds total cycle time.

OnOff A setting of *OnOff* allows the control to operate in on/off mode. This setting forces the control to turn off at set point, and on at the set point plus the differential (*SP_d*). When selected the *tune*, *Pb*, *rES*, *OFFS*, *rTE*, and *RRUP* selections in the Secondary menu and the *SPOL* and *SPDH* selections in the Secure menu are suppressed.

1 A setting of 1 is recommended for solid state outputs (SSR or 5VDC).

2 to 80 Time Proportioning Control is adjustable in 1 sec. steps. Recommended for mechanical outputs (relays, solenoids, etc.). For best contact life, a time should be selected as long as possible without causing the process to wander.

SP_d Set Point On-Off Differential. Select 1 to 999°F. This value will be negative for reverse acting set points, and positive for direct acting outputs. Set the value for the amount of temperature difference between the turn off point (set point) and the turn on point. Only appears if **CY** is set to *OnOff*.

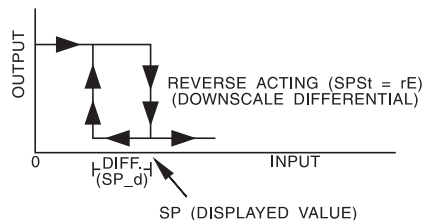
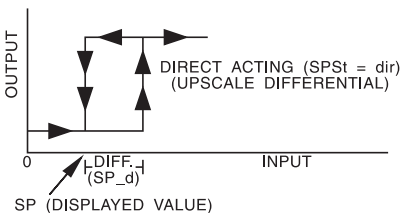

tune Tuning Choice: Select *SELF* or *Pid*.

SELF The Controller will evaluate the Process and select the PID values to maintain good control. The ramp function (*rTE*) can not be selected while *SELF tune* is active. The temperature descriptor will flash while *SELF tune*

is active. The control will switch to *SELF TUNE* when the tuning function is complete.

P id Manually adjust the PID values. PID control consists of three basic parameters, Proportional Band (Gain), Reset Time (Integral), and Rate Time (Derivative).

Pb Proportional Band (Bandwidth). Select 5 to 5000 °F (3 to 2778 °C).

rES Automatic Reset Time. Select *OFF*, 0.1 to 99.9 minutes. Select *OFF* to switch to *OFFS*.

OFFS Manual Offset Correction Select *OFF*, 0.1 to 99.9%. Select *OFF* to switch to *rES*.

r tE Rate Time. Select *OFF*, 0.01 to 99.99 minutes, Derivative.

ArUP Anti- Reset Wind-up Feature: Select *On* or *OFF*.

On When ArUP is *On* the accumulated Reset Offset value will be cleared to 0% when the process input is not within the Proportional Band.

OFF When ArUP is *OFF*, the accumulated Reset Offset Value is retained in memory when the process input is not within the Proportional Band.

r t Ramp Time: Select *OFF*, 00.01 to 99.99 (HH.MM). When value is entered, control calculates a ramp slope from the current temperature to *SP* over the time entered. Changing *r t* or *SP* (or pressing ENTER at either menu item) restarts the ramp function, and re-calculates the slope. The right hand decimal point of the display will flash while the ramp function is active. *SELF TUNE* can not be selected while the ramp function is active. Selecting *OFF* will stop a current ramp and drive the output as necessary to reach set point

InPC Input Correction: Select ± 500 °F (± 278 °C). This feature allows the input value to be changed to agree with an external reference or to compensate for sensor error. Note: InPC is reset to zero when the input type is changed, or when decimal position is changed.

Filt Digital Filter: Select *OFF*, 1 to 99. In some cases the time constant of the sensor, or noise could cause the display to jump enough to be unreadable. A setting of 2 is usually sufficient to provide enough filtering for most cases, (2 represents approximately a 1 second time constant). When the 0.1 degree resolution is selected this should be increased to 4. If this value is set too high, controllability will suffer.

SECURE MENU

Hold **UP ARROW & ENTER** for 5 Seconds. Press **INDEX**  to advance to the next menu item. Press  UP ARROW &  DOWN ARROW keys to change the value in the display. Press  ENTER to retain the value.

SECr Security Code: See the Security Level Selection and the Password Table in this manual, in order to enter the correct password.

inP Input Type: Select one of the following. The selections are limited to the input type you ordered. If you ordered a thermocouple input control, make your selection from the thermocouple list. If you ordered an RTD input, select from the RTD list.

Thermocouple selections:

- J- #C** Type "J" Thermocouple, (NIST)
- KR** Type "K" Thermocouple
- t-** Type "T" Thermocouple
- E-** Type "E" Thermocouple
- n-** Type "N" Thermocouple

RTD selections:

- P385** 100 ohm Platinum (DIN 0.00385 $\Omega/\Omega/^\circ\text{C}$).
- P392** 100 ohm Platinum (NIST 0.00392 $\Omega/\Omega/^\circ\text{C}$).
- n 120** 120 ohm Nickel (US Ind. 0.006725 $\Omega/\Omega/^\circ\text{C}$).

F-C Select temperature descriptor for Fahrenheit or Celsius.
F °F descriptor is On and temperature inputs will be displayed in actual degrees Fahrenheit.
C °C descriptor is On and temperature inputs will be displayed in actual degrees Celsius.

dPt Decimal Point Positioning: Select **0** or **0.0**. This only effects the Process Value, SP, ALLo, ALHi, and InPC.

- 0** No decimal Point is selected.
- 0.0** One decimal place is selected. If the Process Value moves outside of the decimal point range ends (-199.9 to +999.9), the Process Value display will autorange to whole degree resolution. When the Process Value returns to the decimal point range, the display will autorange back to tenth dergee resolution.

inPt Input Fault Timer: Select **OFF**, **0.1** to **540.0** minutes. Whenever an Input is out of range (UFL or OFL displayed), shorted, or open the timer will start. When the time has elapsed, the controller will revert to a safe condition (Output Off, Flashing Display). If OFF is selected, the Input Fault Timer will not be recognized (time = infinite).

- SP_L* Set Point Low: Select from the lowest input range value to *SP_H* value. This will set the minimum SP value that can be entered. The value for SP will stop moving when this value is reached.
- SP_H* Set Point High: Select from the highest input range value to *SP_L* value. This will set the maximum SP value that can be entered. The value for SP will stop moving when this value is reached.
- SP_{St}* Set Point State: Select *d ir* or *rE*.
- d ir* Direct Action. As the input increases the output will increase. Most commonly used in cooling processes.
- rE* Reverse Action. As the input increases the output will decrease. Most commonly used in heating processes.
- SP_{OL}* Set Point Output Low Limit: Select 0 to 100% but not greater than *SP_{OH}*. This item limits the lowest output value. This is useful for adding a bias to the process when needed.
- SP_{OH}* Set Point Output High Limit: Select 0 to 100% but not less than *SP_{OL}*. This item allows setting the maximum output limit. This is useful with processes that are over powered.
- SP_{LP}* Set Point Lamp: Select 0 on or 0oFF.
- 0 on Lamp ON when Output is ON.
- 0oFF Lamp OFF when Output is ON.

ALARM TYPE AND ACTION (if present)



Caution: In any critical application where failure could cause expensive product loss or endanger personal safety, a redundant limit controller is required.

When setting an alarm value for an absolute alarm ($RLt = Abs$), simply set the value at which the alarm is to occur.

When setting the alarm value for a deviation alarm ($RLt = dE$), set the difference in value from the Set Point (SP) desired. For example if a low alarm is required to be 5 degrees below the SP, then set $RLLo$ to -5. If a high alarm is required 20 degrees above the SP, then set $RLHi$ to +20. If SP is changed, the alarm will continue to hold the same relationship as originally set.

The diagram below shows the action and reset functions for both absolute and deviation alarms.

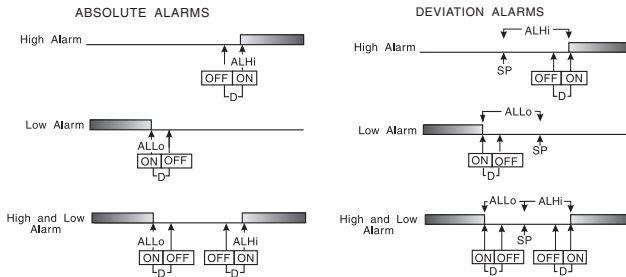

D = 2 Degrees F

When Alarm Power Interrupt, *ALP I*, is programmed *On* and Alarm Reset, *ALR E*, is programmed for *Hold*, the alarm will automatically reset upon a power failure and subsequent restoration if no alarm condition is present.



If Alarm Inhibit, *AL I*, is selected *On*, an alarm condition is suspended upon power up until the process value passes through the alarm set point once. Alarm inhibit can be restored as if a power up took place by pressing both the **INDEX** and **ENTER** keys for 5 seconds.



WARNING: IF INHIBIT IS ON AND A POWER FAILURE OCCURS DURING A HIGH ALARM, RESTORATION OF POWER WILL NOT CAUSE THE ALARM TO OCCUR IF THE PROCESS VALUE DOES NOT FIRST DROP BELOW THE HIGH ALARM SETTING. DO NOT USE THE ALARM INHIBIT FEATURE IF A HAZARD IS CREATED BY THIS ACTION. BE SURE TO TEST ALL COMBINATIONS OF HIGH AND LOW ALARM INHIBIT ACTIONS BEFORE PLACING CONTROL INTO OPERATION.

The following menu items apply only to the alarm.

- AL* Alarms: Select *OFF*, *Lo*, *Hi*, or *HiLo*.
 - OFF* Alarms are turned OFF. No Alarm menu items appear in the Secondary and Secure menus.
 - Lo* Low Alarm Only. *ALLo* appears in the Secondary Menu.
 - Hi* High Alarm Only. *ALHi* appears in the Secondary Menu.
 - HiLo* High and Low Alarms. Both share the same Alarm Relay output.
- ALt* Alarm Type: Select *AbS* or *dE*
 - AbS* Absolute Alarm that may be set anywhere within the values of SPL and SPH and is independent of SP.
 - dE* Deviation Alarm that may be set as an offset from SP. As SP is changed the Alarm Point will track with SP.
- ALrE* Alarm Reset: Select *OnOFF* or *Hold*.

<i>OnOFF</i>	Automatic Reset.
<i>Hold</i>	Manual Reset. Reset (acknowledge) by simultaneously pressing the   INDEX & DOWN ARROW keys for 5 sec.
<i>ALP</i>	Alarm Power Interrupt: Select <i>On</i> or <i>OFF</i> .
<i>On</i>	Alarm Power Interrupt is ON.
<i>OFF</i>	Alarm Power Interrupt is OFF.
<i>ALH</i>	Alarm Inhibit: Select <i>On</i> or <i>OFF</i> .
<i>On</i>	Alarm Inhibit is ON. Alarm action is suspended until the process value first enters a non-alarm condition.
<i>OFF</i>	Alarm Inhibit is OFF.
<i>ALSt</i>	Alarm Output State: Select <i>CLOS</i> or <i>OPEN</i> .
<i>CLOS</i>	Closes Contacts at Alarm Set Point.
<i>OPEN</i>	Opens Contacts at Alarm Set Point.
<i>ALLP</i>	Alarm Lamp: Select <i>On</i> or <i>Off</i> .
<i>On</i>	Alarm Lamp is ON when alarm contact is closed.
<i>Off</i>	Alarm Lamp is OFF when alarm contact is closed.

SPECIFICATIONS

Selectable Inputs: Thermocouple or RTD as ordered.

Input Impedance:

Thermocouple = 3 megohms minimum. RTD current = 200 μ A.

Sensor Break Protection: De-energizes control output to protect system.

Set Point Range: Selectable (See range chart on page 16).

Display: One 4 digit, 7 segment 0.3" high LEDs.

Control Action: Reverse (usually heating), Direct (usually cooling) selectable.

Proportional Band: 5 to 5000 $^{\circ}$ F or equivalent $^{\circ}$ C.

Reset Time (Integral): Off or 0.1 to 99.9 minutes.

Rate Time (Derivative): Off or 0.01 to 99.99 minutes.

Cycle Rate: 1 to 80 seconds, and on-off.

On - Off Differential: Adjustable 1 $^{\circ}$ F to 999 $^{\circ}$ F in 1 $^{\circ}$ steps (equivalent $^{\circ}$ C).

Alarm On - Off Differential: 2 $^{\circ}$ F or equivalent in $^{\circ}$ C.

Accuracy: \pm 0.25% of span, \pm 1 least significant digit.

Resolution: 1 degree or 0.1 degree, selectable.

Line Voltage Stability: \pm 0.05% over the supply voltage range.

Temperature Stability: 4 μ V/ $^{\circ}$ C (2.3 μ V/ $^{\circ}$ F) typical, 8 μ V/ $^{\circ}$ C (4.5 μ V/ $^{\circ}$ F) maximum.

Common Mode Rejection: 140 db minimum at 60 Hz.

Normal Mode Rejection: 65 db typical, 60 db at 60 Hz.

Isolation: Relay and SSR outputs are isolated. 5VDC output must not share a common ground with the input.

Supply Voltage: 100 to 240 VAC, nom., +10 -15%, 50 to 400 Hz. single phase; 132 to 240 VDC, nom., +10 -20%.

Power Consumption: 5VA maximum.

Operating Temperature: -10 to +55 °C (+14 to 131 °F).

Storage Temperature: -40 to +80 °C (-40 to 176 °F).

Humidity Conditions: 0 to 90% up to 40 °C non-condensing 10 to 50% at 55 °C non-condensing.

Memory Backup: Non-volatile memory. No batteries required.

Control Output Ratings:

SSR, 3.5 A @ 250 VAC at 25 °C. Derates to 1.25 A @ 55 °C.

Relay, Form A contact (SPST), 3 A @ 250 VAC resistive; 1.5 A @ 250 VAC inductive; Pilot Duty Rating: 250 VA, 2 A @ 125 VAC or 1 A @ 250 VAC.

Switched DC Voltage, 5 VDC @ 20 mA, maximum.

Alarm Relay, Form A contact (SPST). Same rating as control relay (2) above.

Weight: 227 g (8 oz).







Agency Approvals: UL E83725.

Front Panel Rating: IP66 (Type 4X).

DIAGNOSTIC ERROR MESSAGES

DISPLAY	MEANING	SP OUTPUTS	ACTION REQUIRED
<i>UFL</i> or <i>OFFL</i>	Underflow or Overflow: Process value has exceeded input range ends.	Set point output active Alarms active	Input signals may normally go above or below range ends. If not, check input and correct.
<i>bAd</i> <i>inP</i>	<i>UFL</i> or <i>OFFL</i> will sequence to display one of these messages if the <i>inPt</i> is set for a time value.	Set point output inactive Alarms active	To reset use the INDEX AL ENTER INDEX & ENTER keys. When <i>inPt</i> (input fault timer) has been set for a time, the outputs will be turned off after the set time. Setting the time to <i>OFF</i> causes the outputs to remain active, however <i>UFL</i> or <i>OFFL</i> will still be displayed.
<i>OPEN</i> <i>inP</i>	For RTD inputs RTD is open or shorted. For THERMOCOUPLE inputs thermocouple is open.		Correct or replace sensor.

DIAGNOSTIC ERROR MESSAGES

DISPLAY	MEANING	SP OUTPUTS	ACTION REQUIRED
<i>CHEC CAL</i>	<p>Check calibration appears as an alternating message if the instrument calibration nears tolerance edges.</p> <p>Check calibration appears as a flashing message if the instrument calibration exceeds specification.</p>	<p>Set point output active Alarms active</p> <p>Set point output inactive Alarms active</p>	<p>Remove the instrument for service and / or recalibration. To reset use the   INDEX & ENTER keys.</p> <p>Remove the instrument for service and / or recalibration. To reset use the   INDEX & ENTER keys.</p>
No display lighted	Display is blank. Instrument may not be getting power, or the supply voltage is too low.	Set point output inactive Alarms inactive	Check that the power supply is on, or that the external fuses are good.
<i>FR IL tEst</i>	Fail test appears upon power up if the internal diagnostics detect a failure. This message may occur during operation if a failure is detected. Displays flash.	Set point output inactive Alarms inactive	<p>The display alternate between <i>FR IL tEst</i> and one of the following messages: <i>FRct dFLt</i>: Memory may be corrupted. Press the   DOWN ARROW and ENTER keys to start the factory default procedure. Re-check controller programming.</p> <p><i>rEt FRct</i>: Can not recover from error, return to factory for service.</p>
<i>CHEC SP CHEC ALLO CHEC ALH.</i>	This message will appear upon power up if the set point is set outside of the <i>SP_L</i> or <i>SP_H</i> values.	Set point output inactive Alarms active	Correct the <i>SP</i> or adjust the <i>SP_L</i> or <i>SP_H</i> values by programming new values.
<i>CHEC SP_L or CHEC SP_H</i>	This message appears at power up if <i>SP_L</i> or <i>SP_H</i> values are programmed outside the input range ends.	Set point output inactive Alarms inactive	Correct the <i>SP_L</i> or <i>SP_H</i> values by programming new values.

Input Ranges (as ordered)

INPUT TYPE 1	RANGE °F	RANGE °C
Type J or L Thermocouple	-100 to +1600	-73 to +871
Type K Thermocouple	-200 to +2500	-129 to +1371
Type T Thermocouple	-350 to +750	-212 to +398
Type E Thermocouple	-100 to +1800	-73 to +982
Type N Thermocouple	-100 to +2372	-73 to +1300

INPUT TYPE 2	RANGE °F	RANGE °C
RTD 100 Ohm Plt. 0.00385 RTD	-328 to 1607	-200 to +875
RTD 100 Ohm Plt. 0.00392 RTD	-328 to 1607	-200 to +875
RTD 120 Ohm Ni. 0.006725 RTD	-112 to +608	-80 to +320

DIMENSIONS

(All dimensions in millimeters with inches in parenthesis.)

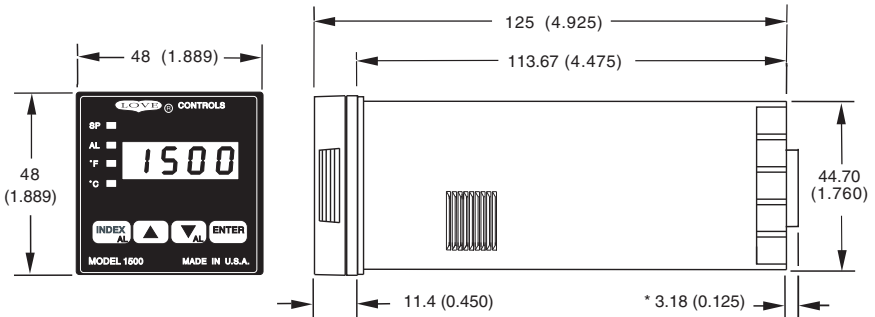

Panel cutout for all models is 45mm x 45mm (1.775 in x 1.775 in).

Allow for 13 mm (0.5 in) clearance at the rear of the instrument.

* Present for SSR outputs.