

S418

# Compact Thermal Mass Flow Meter

Pro-Inline



**SMARTPHONE ANDROID APP**  
For remote configuration



**POINT-OF-USE MEASUREMENT**  
Monitor machines and air consumers



**COMPACT DESIGN**  
Can be installed anywhere



**TOTAL FLOW**  
No bypass measurement

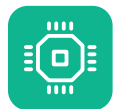

**EASY PROCESS MONITORING**  
Effective and inexpensive recording



**ACCURATE RESULTS**  
Integrated flow conditioner



## Benefits

- ✓ Highly versatile flow and consumption meter for compressed air and technical gases
- ✓ Integrated pressure sensor optional
- ✓ Integrated data logger for measurement recordings as standard feature
- ✓ Various process connection sizes available: DN8, DN15, DN20, DN25 and DN32 (G-inner-thread)
- ✓ Accurate monitoring of gas supplies and consumers
- ✓ Integrated flow conditioner eliminates the need of straight inlet sections

## Powerful Pro Version – Flexible Installation

The S418 Thermal Mass Flow Meters offers compressed air flow and gas measurement directly at the point of use.

It comes standard with wireless communication interface to help the user quickly and easily check the flow meter readings or adjust the settings via the SUTO flow meter app.

Improve your compressed air system efficiency, while helping reduce compressed air and gas usage and operating costs by monitoring:

- Flow and Consumption
- Pressure
- Temperature

## Connection

### Pin assignment connector plug M8

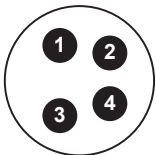

- Every sensor includes 5m M8 cables with open ends
- Sensor with Modbus/RTU or M-Bus include 1 cable
- Sensors with Analog output include 2 cables

Output	Connector	Pin 1	Pin 2	Pin 3	Pin 4
Modbus/RTU	A	D-	-VB	+VB	D+
	B	D-	GND	NA	D+
Analog and Pulse	A	I-	-VB	+VB	I+
	B	I-	P	P	I+
M-Bus	A	M-bus	-VB	+VB	M-bus
	B	M-bus	NA	NA	M-bus
Wire color		Brown	White	Blue	Black

## Gas Monitoring Application

The S418 is ideal for remote locations or high accuracy compressed air flow and gas measurements with its built-in data logger and optional pressure sensing.

The compact flow meters provide accurate gas flow monitoring, helping to discover weak points in the process flow, thus ensuring continuity and profitability.

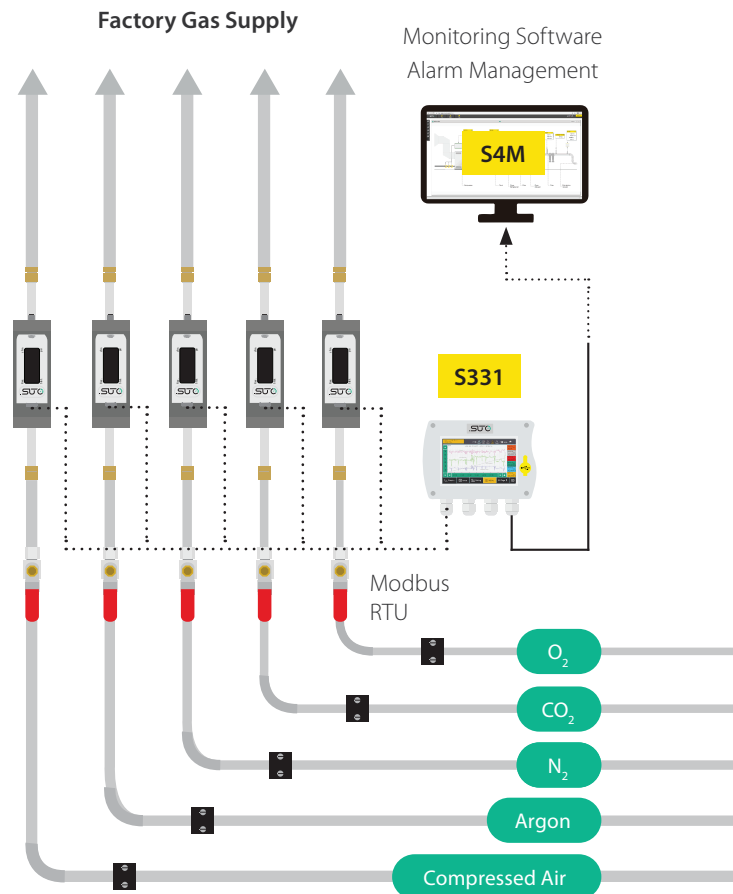



## Wireless Connection

The free S4C-FS App offers a unique wireless connection to every SUTO flow meter for online readings and configuration.

Especially during installation and setup all settings can be performed using a smartphone, there is no need to carry a PC and an interface on site. This saves a lot of time and is the easy way to get reliable sensor readings.

Every sensor is protected by default. To perform changes on the flow meter, first a QR code must be scanned.

## Flow Conditioner

Asymmetric velocity profiles, swirl, and other factors caused by bends in pipes can lead quickly to inaccurate readings. But sometimes there is not enough space to have straight inlet conditions for accurate readings.

The highly engineered flow conditioner solves this problem. Unlike a standard flow conditions disk, the 3D design of the flow conditioner allows measurements with no additional straight inlet piping at all. Thanks to the innovative mechanical design, the pressure loss is negligible small (<30 hPa), offering high accurate measurements in difficult pipe conditions.

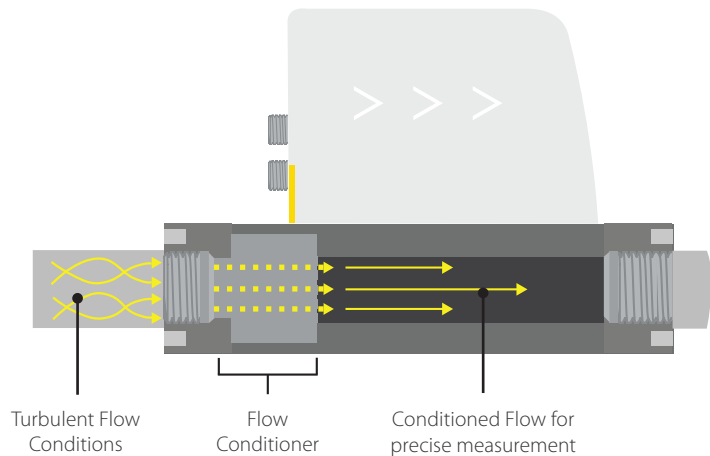

## Connect several S418 to Modbus Master

The S418 with Modbus/RTU interface can be easily daisy-chained to a Modbus Master device such as S331 by using RS-485 splitter (A554 3310) and the M8 to M12 converter cable (A553 0161). Through this method you can add up to 16 flow meters to the master.

**Remark:** The S331 can maximum provide 10 W power to the connected devices. If more power is required a separate power supply is needed..

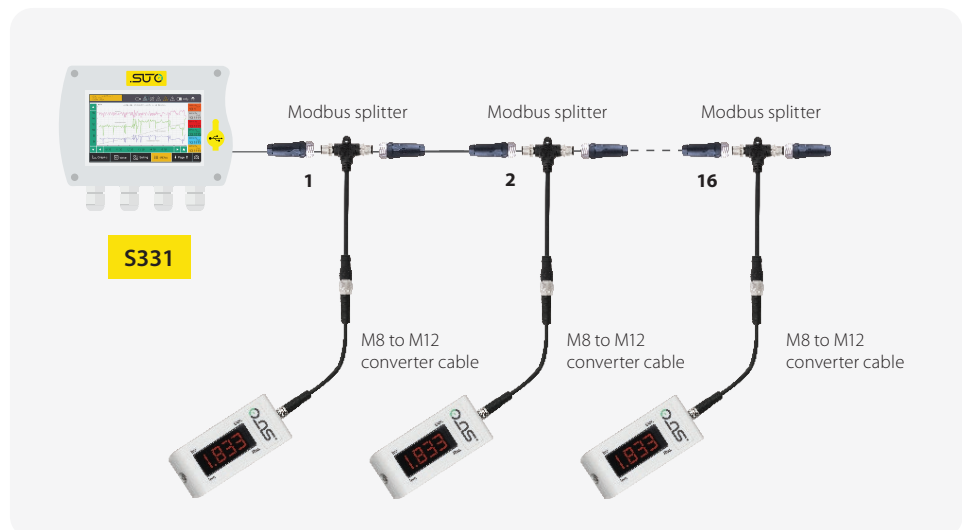

## Display Direction

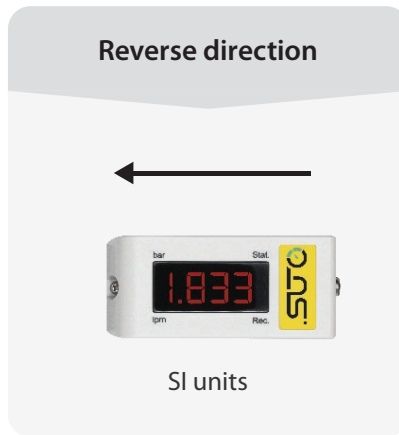

## Measuring Range in Air (l/min)

Range	Standard Configuration				
Process connection	DN8	DN15	DN20	DN25	DN32
Standard range (S)	250	1000	2000	3500	6000
Low range (L)	50	200	400	700	1200

Stated measuring ranges for S418 under following conditions:

- Standard flow in air in l/min
- Reference pressure: 1000 mbar
- Reference Temperature: +20 °C

Measuring ranges in Nitrogen are different. Please contact us for details at [sales@suto-itec.com](mailto:sales@suto-itec.com)



## Dimensions

Dimensions in mm	a	b	c	d	e
DN8/DN15	35.0	93.0	120.4	35.0	48.0
DN20/DN25	48.0	106.0	178.0	48.0	61.0
DN32	60.0	118.0	222.0	60.0	73.0

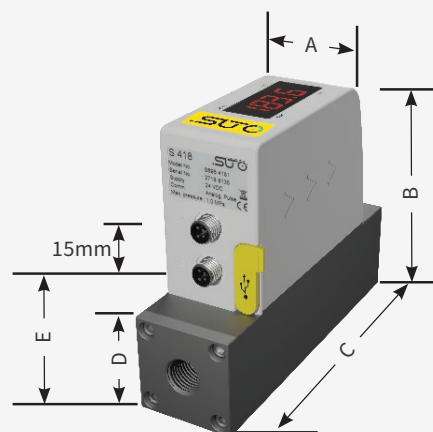

# Technical Data

## Measurement

### Flow

Accuracy	1.5 % o.RDG ±0.3 % FS
Selectable units	l/min, cfm, kg/h, m <sup>3</sup> /h
Measuring range	see table on the previous page
Repeatability	0.5 % o.RDG
Sensor	Thermal mass flow sensor
Sampling rate	10/sec
Turndown ratio	100:1
Response time (t90)	0.5 sec

### Consumption

Selectable units	m <sup>3</sup> , ft <sup>3</sup> , l, kg
------------------	--

### Pressure

Accuracy	0.5 % FS
Selectable units	bar, psi
Measuring range	0 ... 10 bar(g)
Sensor	Piezo resistive sensor

### Reference conditions

Selectable conditions	20 °C 1000 mbar (ISO1217), 0 °C 1013 mbar (DIN1343) freely adjustable
-----------------------	---

## Signal / Interface & Supply

### Analog output

Signal	4 ... 20 mA (4-wire), isolated
Scaling	0 ... max flow freely adjustable
Load	Max 250 Ω
Update rate	3/sec

### Pulse output

Signal	Switch output, normally open, max 30 VDC, 200 mA
Scaling	1 pulse per consumption unit

### Fieldbus

Protocol	Modbus/RTU
----------	------------

### Supply

Voltage supply	15 ... 30 VDC
Current consumption	120 mA @ 24 VDC

### Data interface

Connection	USB micro
------------	-----------

## General data

### Configuration

Wireless	S4C-FS App for mobile phones
PC Software	S4A PC software for download and data analyzes

### Display

Integrated	4 digit LED
------------	-------------

### Data Logger

Storage	8 Mio. values
---------	---------------

### Material

Process connection	Aluminum alloy
Housing	PC + ABS
Sensor	Ceramic, glass coated
Metal parts	Aluminum alloy

### Miscellaneous

Electrical connection	2 x M8 (4 pole)
Protection class	IP54
Approvals	CE, RoHS, FCC
Process connection	G-thread
Weight	0.45 ... 1.3 kg (depends on model)

## Operating conditions

Medium	Air, N <sub>2</sub> , O <sub>2</sub> , CO <sub>2</sub> and other gases
Medium quality	ISO 8573: 4.4.3 or better
Medium temperature	0 ... 50 °C
Medium humidity	< 90 % rH, no condensation
Operating pressure	0 ... 16 bar(g)
Ambient temperature	0 ... 50 °C
Ambient humidity	< 95 % rH
Storage temperature	-30 ... 70 °C
Transport temperature	-30 ... 70 °C
Pipe sizes	DN8, DN15, DN20, DN25, DN32

# Ordering

Please use the following tables to assist in placing your order with our sales staff.

## S418 Compact Thermal Mass Flow Meter (Pro-Inline)

Order No.	Description
S695 418	S418 Compact Thermal Mass Flow Meter with integrated data logger, G inner thread, 24 VDC, 5 m cable with M8 connector and open ends included

### Size + Pressure sensor option

S695 4180	DN8
S695 4181	DN15
S695 4182	DN20
S695 4183	DN25
S695 4184	DN32
S695 4185	DN8, Pressure sensor 10 bar(g)
S695 4186	DN15, Pressure sensor 10 bar(g)
S695 4187	DN20, Pressure sensor 10 bar(g)
S695 4188	DN25, Pressure sensor 10 bar(g)
S695 4189	DN32, Pressure sensor 10 bar(g)

### Range

A1465	Standard range version
A1453	Low range version

### Output

A1455	S418: Analog 4 ... 20 mA, Pulse output
A1456	S418: Modbus/RTU output
A1457	S418: M-Bus output

### Fluid Medium 1

A1007	Air
A1008	CO <sub>2</sub>
A1009	O <sub>2</sub> (Oil- & grease-free cleaned)
A1010	N <sub>2</sub>
A1011	N <sub>2</sub> O
A1012	Argon
A1013	Natural Gas
A1014	H <sub>2</sub> (Real gas calibration)
A1015	Other Gas (Please specify)
A1016	He (Real gas calibration)
A1017	C <sub>3</sub> H <sub>8</sub>

### Fluid Medium 2 (same selections as above)

A1003	No 2nd Gas
-------	------------

### Units

A1467	With SI units
A1459	With imperial units

### Display direction

A1463	Standard display direction (left to right)
A1461	Reverse display direction

## Ordering Example

<b>Example</b>	S418 DN25, without pressure sensor, Standard range, Modbus/RTU, CO <sub>2</sub> , No 2nd gas, with SI units, Standard display direction
----------------	---

<b>Order Code</b>	S695 4183.A1465.A1456.A1008.A1003.A1467.A1463
-------------------	---

## S418 Accessories

Order No.	Description
A554 0109	Mains power supply 100-240 VAC / 24 VDC, 0.5 A, 2 m cable with M8 connector
A553 0137	Connection cable to S551, 5 m
M599 7020	S4A data analysis software, for data logger S418
A553 0161	M8 to M12 converter cable for Modbus splitter
A553 0171	Cable to connect power bank, 1.8 m, USB-C connector for power bank, M8 connector
A554 3310	RS-485 / Modbus splitter

## Mobile Power

S418 powered by power bank with connection cable A553 0171

**Note:** power bank must be sourced locally due to shipping restrictions [USB-C, 20 V, min. 100 mA]

