



Product Guide 2023/24

Next Level of Compressed Air, Gas
and Liquid Monitoring



Be smart. Measure it.

Advanced Measurement Solutions

Compressed Air and Gas Monitoring - get your system under control

The use of compressed air and technical gases in modern production processes has become indispensable. Compressed air is used to drive actuators, machines and to control other automated processes. Technical gases and air are used to conserve food or are even becoming part of the product, like in the beverage production.

This leads to two crucial aspects:

1

Energy Consumption

Air compressors typically convert ~80 ... 90 % of the electrical energy into heat and only 10 ... 20 % into compressed air. This makes compressed air 5 to 10 times more expensive than electricity. Measuring and Monitoring compressors, the consumptions, pressure and flow rates becomes major part in a world with limited energy resources.

2

Purity and Quality

Having air and gases becoming a part of your product and process means, that we need to have a control system in place, insuring that filtration systems are working as they should, 24 hours a day, 7 days a week. Only by regular measurements or by using monitoring solutions this can be achieved.

Flow Meters Compressed Air & Gas



Dew Point Sensors



Leak Detection

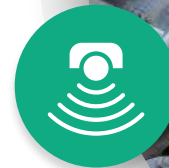

Application Software



Why monitor compressed air and gases?

- ✓ System Performance and Reliability
- ✓ Energy Efficiency and Cost Reduction
- ✓ Product Quality and Safety
- ✓ ISO Purity Requirements



Be smart.
Measure it.

Flow Meters
Liquids & Steam



Air Quality
& Purity



Displays
Data Logger
IoT



Energy Meter
Pressure Sensors

SUTO is a leader and trusted global partner

for reliable measurement and monitoring solutions for compressed air and gas systems.

Our wide range of products play a vital role in system processes of leading companies around the world.

Since our foundation in 2005, we offer our customers outstanding service and solutions and continue to innovate dependable measurement technology.

WHY SUTO

Years of Experience

We look back on many years of experience working in the compressed air and gas market. We are a trusted global partner by delivering value-creating solutions.

Design Driven

Many customers require unique and custom-designed solutions. We adapt to full-scale, personalized systems, ensuring the best possible solution.

Product Knowledge

We provide a wide portfolio of compressed air and gas devices and solutions which can be seamlessly integrated into your systems and processes without causing downtimes.

Powered by Innovation

We are pioneers in compressed air measurement by rethinking traditional methods and reaching new levels of time-efficient measurement, while constantly improving our portfolio.

Contents

Introduction	2
Flow and Consumption Sensors for Air and Gases	
S401 / S421 Thermal Mass Flow Meter (Insertion and Inline)	5
S415 Compact Thermal Mass Flow Meter (Eco-Inline)	13
S418 Compact Thermal Mass Flow Meter (Pro-Inline)	19
S418-V Compact Thermal Mass Flow Meter for Vacuum Applications (Inline)	25
S450 / S452 Thermal Mass Flow Meter for Heavy Duty and Ex Applications (Insertion and Inline)	31
S430 Pitot Tube Flow Meter for Wet Air (Insertion)	37
S409 Thermal Mass Flow Direction Switch (Insertion)	43
Flow and Consumption Sensors for Liquids and Steam	
S435 Vortex Flow Meter for Steam (Inline)	47
S461 Ultrasonic Flow Meter for Liquids (Clamp-on)	51
S462 Compact Ultrasonic Flow Meter for Liquids (Clamp-on)	56
Dew Point Sensors for Compressed Air and Gases	
S211 / S215 / S220 Dew Point Transmitters	60
S230 / S231 Dew Point Transmitters for Ex Applications	65
S305 Dew Point Monitor (-50 ... +20 °C Td / -20 ... +50 °C Td)	69
S520 Portable Dew Point Meter (-100 ... +50 °C Td)	74
Displays and Data Loggers	
S330 / S331 Display and Data Logger	79
S320 Display	86
S551 Portable Display and Data Logger	89
Application Software and Mobile Apps	
S4M SaaS Smart Compressed Air System Monitoring Software	96
S4A Data Analysis Software	103
S4C-FS Smartphone App for Air and Gas Flow Meter	105
Compressed Air Quality and Purity Measurement	
S120 Oil Vapor Monitor	107
S130 / S132 Laser Particle Counter	111
S600 Portable Compressed Air Purity Analyzer	116
S601 Stationary Compressed Air Purity Monitor	123
S605 Portable Breathing Air Quality Analyzer	129
S606 Stationary Breathing Air Quality Analyzer	135
Leak Management	
S530 Ultrasonic Leak Detector (Eco Version)	141
S531 Smart Ultrasonic Leak Detector	145
Leak Management System (LMS)	150
Further Useful Sensors and Systems	
S110 Power and Energy Meter	153
S010 / S011 Pressure Transmitter	157
S020 Temperature Transmitter	160
S030 Electrical Current Transmitter	162
Calibration and Certification	165
Accessories	168
Power Consumption Overview in Catalog	173

S401 / S421

Thermal Mass Flow Meter

Insertion / Inline



S401



S421

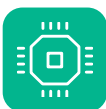

PROCESS MONITORING
High accuracy and reliable measurements



TOTALIZER INTEGRATED
Total consumption stored internally

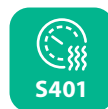

S401 INSERTION METER
Installation under pressure



MOBILE APP
For remote configuration



INTEGRATED DISPLAY
For on site values

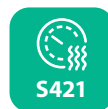

S421 IN-LINE METER
High accuracy and easy to install



Benefits

- ✓ S401 can be installed under pressure through a 1/2" ball valve
- ✓ S421 with measuring section for accurate and reliable readings
- ✓ No additional pressure or temperature compensation needed, thanks to thermal mass flow measurement
- ✓ Fast response time with a wide measuring range
- ✓ Thermal mass flow meter can be used in different process gases like: N₂, CO₂, O₂ and many other technical gases

1 Optional Color Display

On-site display for live value readings, total consumption counter and convenient sensor settings. Totalizer with 10 digits (1 999 999 999)

2 Various Outputs

S401 and S421 thermal mass flow meters are perfectly suited to be integrated into process controls or high-level monitoring systems. Various output options are offered for a seamless integration:

- Isolated 4... 20 mA output for actual flow readings
- Isolated Pulse output for totalizer
- Modbus/RTU to read all values digitally
- Modbus/TCP with PoE support to connect the meters to the local network and power them via Ethernet

3 Robust Materials

The industrial IP65 Polycarbonate-ABS housing offers the best protection in rough environments. The metal parts are made from high grade stainless steel, made to last forever.

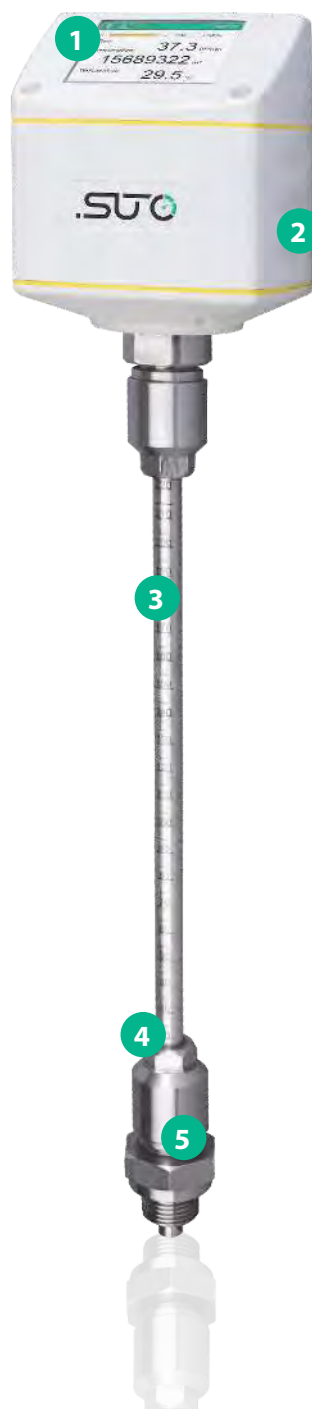

4 Flexible and Easy Installation

- The insertion type flow meters supports any pipe size from 1" up to 12" or even bigger pipes. Thanks to the insertion through a 1/2" ball valve, the S401 can be installed under pressure and is perfectly suited for installations where shutdowns are not acceptable.
- The in-line type are offered with measuring sections from 1/2" up to 3" and can be easily integrated into existing piping systems.

5 Thermal Mass Flow Sensor

The build in sensor is using the thermal mass flow principle. This comes with main advantages:

- The sensor can cover a wide measuring range at high accuracy.
- The fast response times, no moving parts and minimal pressure loss are making them most suited sensors for volumetric flow and consumption measurement of compressed air and gases.
- There is no need to compensate the line pressure and temperature additionally, making them most efficient in terms of installations and costs.

Wireless Connection

The unique wireless connection on every flow meter is unlike its competition. Through the free S4C-FS App, live values can be read from the meters.

But not only during operation, the smartphone app is useful. Especially during installation and setup all settings can be performed using a smartphone, there is no need to carry a PC and an interface on site. This saves a lot of time and is the easiest way to get reliable sensor readings.

Every sensor is protected by default, to perform changes on the flow meter, first a QR code must be scanned.



Installation and Sensor Removal

S401

S401 can be installed under pressure through a 1/2" ball valve. The sensor tip must be in the pipes center.

- Tube diameters of DN25 and above
- 2 installation types: center installation and 100 mm insertion depth installation for bigger pipes (> DN250)
- Installation under pressure through 1/2" ball valve

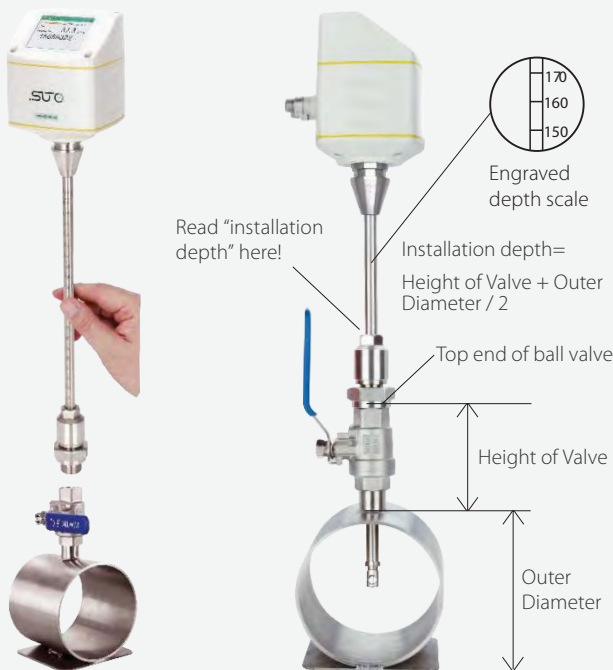

S421

The S421 sensor unit can be easily removed for calibration. (Closing cap separately available)

- Pipes sizes available: DN15, DN20, DN32, DN40, DN50, DN65, DN80
- Fits your needs: various process connections available (R-thread, EN 1092-1 flange or ANSI flange)
- Exchangeable sensor unit (easy sensor swap)
- Optional flow conditioner, no need for a straight inlet anymore



Connect several Flow Meters to Modbus Master

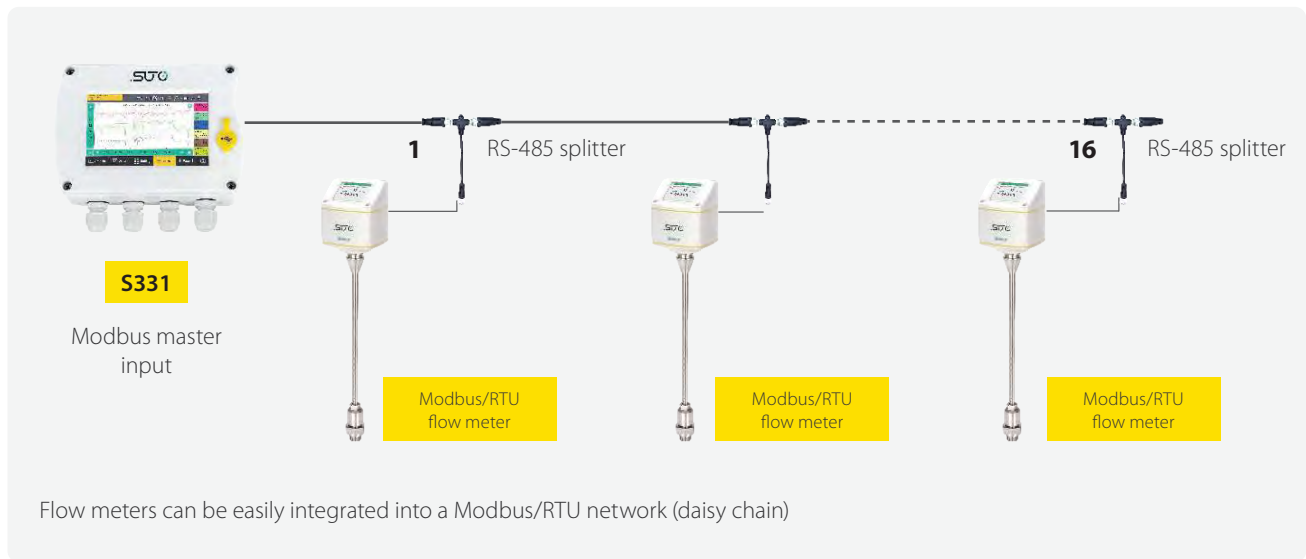

Volumetric Flow Ranges

Pipe Specifications			S401			S421
Inch	DN	DI (mm)	S401-S (m³/h)	S401-M (m³/h)	S401-H (m³/h)	Measuring range from to
½"	DN15		-	-		0.5 ... 90 m3/h
¾"	DN20		-	-		0.9 ... 170 m3/h
1"	DN25	27.3	0.5 ... 147.7	0.6 ... 294.7	0.6 ... 356.9	1.5 ... 290 m3/h
1¼"	DN32	36.0	0.9 ... 266.3	1.2 ... 531.5	1.2 ... 643.5	2 ... 500 m3/h
1½"	DN40	41.9	1.2 ... 366.7	1.5 ... 731.9	1.5 ... 886.2	3 ... 700 m3/h
2"	DN50	53.1	2.0 ... 600.1	2.5 ... 1197.6	3.0 ... 1450.0	4 ... 1000 m3/h
2½"	DN65	68.9	3.5 ... 1026.5	5.0 ... 2048.6	5.0 ... 2480.4	6 ... 1500 m3/h
3"	DN80	80.9	5.0 ... 1424.4	7.0 ... 2842.7	7.0 ... 3441.9	8 ... 2500 m3/h
4"	DN100	100.0	10 ... 2183.3	12 ... 4357.2	12.0 ... 5275.7	
5"	DN125	125.0	13 ... 3419.6	18 ... 6824.4	18.0 ... 8263.1	
6"	DN150	150.0	18 ... 4930.1	25 ... 9838.9	25.0 ... 11913.1	
8"	DN200	200.0	26 ... 8785.6	33 ... 17533.3	42.0 ... 21229.5	
10"	DN250	250.0	40 ... 13743.9	52 ... 27428.5	60.0 ... 33210.7	
12"	DN300	300.0	60 ... 19814.8	80 ... 39544.1	100.0 ... 47880.4	

Mobile Power

S401 / S421 powered by power bank with connection cable A553 0154.

Note: power bank must be sourced locally due to shipping restrictions [USB-C, 20 V, min. 100 mA]

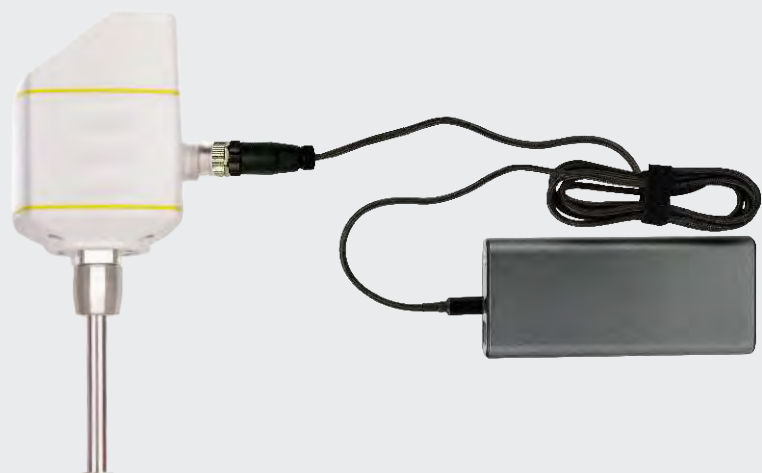

S401 Dimensions

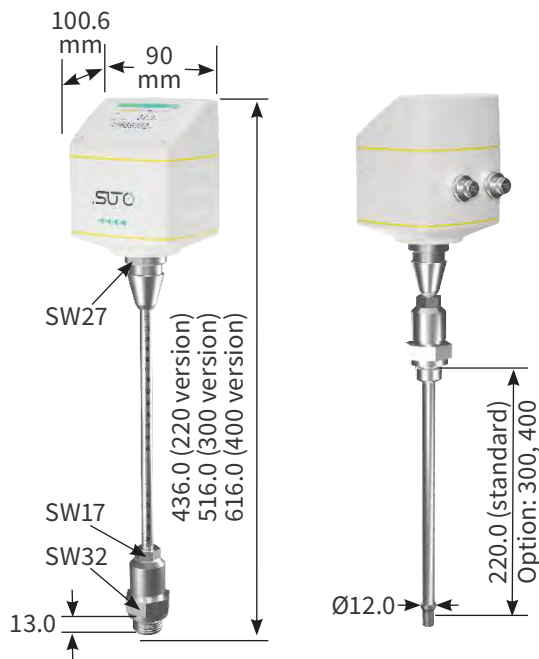

Optional Flow Conditioner

Optional flow conditioner eliminates the straight pipe inlet requirement

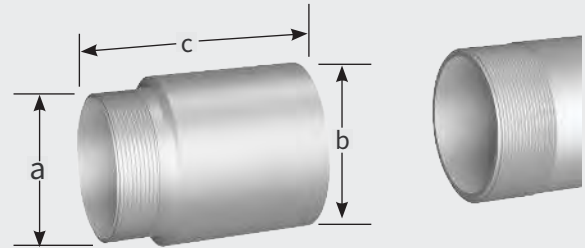

Order No.	DN	a	b in mm	c in mm
A1071	DN15	R 1/2"	24	64
A1072	DN20	R 3/4"	32	69
A1073	DN25	R 1"	37	75
A1074	DN32	R 1.25"	45	92
A1075	DN40	R 1.5"	54	92
A1076	DN50	R 2"	68	105
A1077	DN65	R 2.5"	80	128
A1078	DN80	R 3"	95	142

S421 Dimensions (Flange Type)

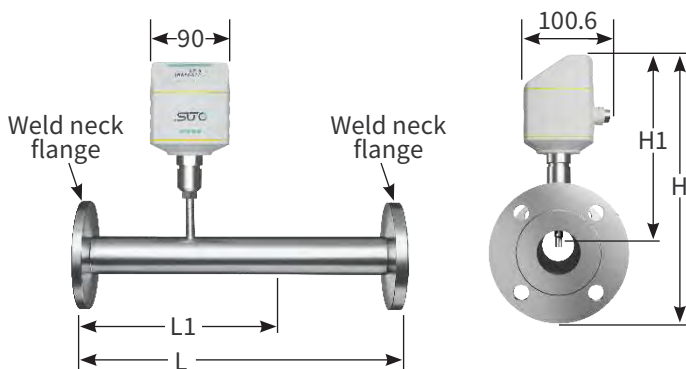

Pipe size inch / (DN)	L (mm)	L1 (mm)	H (mm)	H1 (mm)
½"(DN15)	300	210	234.2	186.7
¾"(DN20)	475	275	239.2	186.7
1"(DN25)	475	275	244.2	186.7
1¼"(DN32)	475	275	256.7	186.7
1½"(DN40)	475	275	261.7	186.7
2"(DN50)	475	275	269.2	186.7
2½"(DN65)	475	275	287.1	194.6
3"(DN80)	475	275	301.0	201.0

S421 Dimensions (Thread Type)

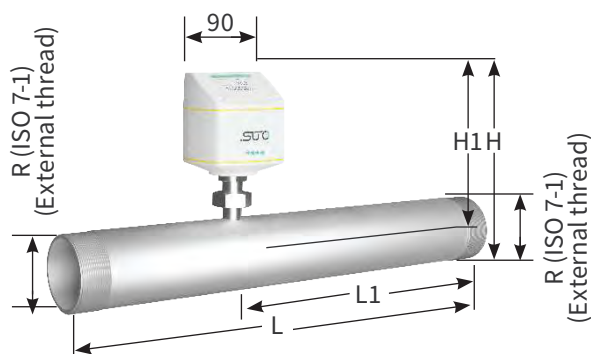

Pipe size inch / (DN)	L (mm)	L1 (mm)	H (mm)	H1 (mm)	R
½"(DN15)	300	210	197.4	186.7	R ½"
¾"(DN20)	475	275	200.2	186.7	R ¾"
1"(DN25)	475	275	203.6	186.7	R 1"
1¼"(DN32)	475	275	207.9	186.7	R 1¼"
1½"(DN40)	475	275	210.9	186.7	R 1½"
2"(DN50)	475	275	216.9	186.7	R 2"
2½"(DN65)	475	275	232.7	194.6	R 2½"
3"(DN80)	475	275	245.5	201.0	R 3"

Technical Data

Measurement

Flow

Accuracy	1.5 % of reading \pm 0.3 % FS (optional 1 % of reading)
Selectable units	m ³ /h, m ³ /min, l/min, l/s, cfm, kg/h, kg/min, kg/s
Repeatability	0.25 % of reading
Sensor	Thermal mass flow sensor
Sampling rate	10 samples / sec
Turndown ratio	200:1
Response time (t90)	0.1 sec

Consumption

Selectable units	m ³ , ft ³ , l
------------------	--------------------------------------

Reference conditions

Selectable conditions	20 °C 1000 mbar (ISO1217), 0 °C 1013 mbar (DIN1343) freely adjustable
-----------------------	---

Signal / Interface & Supply

Analog output

Signal	4 ... 20 mA (4-wire), isolated
Scaling	0 ... max flow, freely adjustable
Load	max. 250 Ohm
Update rate	Value updated ever 1 sec

Pulse output

Signal	Switch output, normally open, max. 30 VDC, 20 mA
Scaling	1 pulse per consumption unit (selectable)

Fieldbus

Protocol	Modbus/RTU, Modbus/TCP
Update rate	Value updated ever 1 sec

Supply

Voltage supply	15 ... 30 VDC
Current consumption	max. 200 mA

General data

Configuration

Wireless	S4C-FS App for mobile phones
PC Software	USB Service Kit + Software
Others	Display with 2 touch buttons

Display

Integrated	2.4" color graphic display with 3 touch buttons
------------	--

Material

Process connection	Stainless steel 1.4404 (SUS 316L)
Housing	PC + ABS
Sensor	Ceramic, glass coated
Metal parts	Stainless steel 1.4404 (SUS 316L)

Miscellaneous

Electrical connection	2 x M12 (5 pole); 1 x M12 (8-pole x-coded) for TCP
Protection class	IP65
Approvals	CE, RoHS, FCC
Process connection	S401: G1/2" (ISO 228/1) S421: Measuring section with R-thread or Flange

Weight

S401: 0.9 kg S421: 0.4 kg (without measuring section)

Operating conditions

Medium	Air, N2, O2, CO2 and other gases
Medium quality	ISO 8573: 4.4.3 or better
Medium temperature	-30 ... +140 °C
Medium humidity	< 90 % rH, no condensation
Operating pressure	max. 5.0 MPa (> 1.6 MPa need installation device)
Ambient temperature	-30 ... +70 °C, -10 ... +50 °C (with display)
Ambient humidity	< 99 % rH
Storage temperature	-30 ... +70 °C
Transport temperature	-30 ... +70 °C
Pipe sizes	S401: 1/2" ... 12" (bigger pipes on request) S421: 1/2" ... 3"

Ordering

Please use the following tables to assist in placing your order with our sales staff.

S401 Thermal Mass Flow Meter (Insertion type)

Order No.	Description
S695 4100	S401 Thermal Mass Flow Meter, 220 mm shaft
S695 4101	S401 Thermal Mass Flow Meter, 300 mm shaft
S695 4102	S401 Thermal Mass Flow Meter, 400 mm shaft
S695 4103	S401 Thermal Mass Flow Meter, 160 mm shaft
Flow Medium 1	
A1007	Option, flow medium Air
A1008	Option, flow medium CO ₂
A1009	Option, flow medium O ₂ (cleaning for oil and grease-free)
A1010	Option, flow medium N ₂
A1011	Option, flow medium N ₂ O
A1012	Option, flow medium Argon
A1013	Option, flow medium Natural Gas
A1014	Option, flow medium H ₂ (For real gas calibration. Please consult manufacturer for this option in advance)
A1015	Other gas (specify gas or gas mix)
A1016	Option, flow medium He (real gas calibration)
A1017	Option, flow medium Propane C ₃ H ₈
A1041	Option, flow medium O ₂ , Ar, CO ₂ (real gas calibration)
A1042	Option, flow medium CH ₄ , NG, N ₂ O (real gas calibration, please consult with manufacturer for this option in advance)
Flow Medium 2 (same selection as above)	
A1003	No 2nd Gas
Range	
A1408	S401: Standard range version (92.7 m/s)
A1401	S401: Max range version (185 m/s)
A1402	S401: High speed range version (220 m/s)
A1403	S401/S421: Low range version (1/3 of standard range)
A1407	S401/S421: Vacuum / Atmospheric range (1/3 of standard range)
Calibration	
A1409	S401/S421: Standard calibration
A1405	S401: Bi-directional calibration
A1404	S401/S421: High accuracy calibration (1 % ± 0.3 % F.S.)
Output	
A1410	Isolated 4 ... 20 mA + pulse output
A1411	Modbus/RTU output
A1413	S401/S421: 4 ... 20 mA + pulse output (pin compatible to S400 / 420)
A1424	Modbus/TCP output with PoE support
Display	
A1425	No Display
A1420	Color graphics display, 2.4" with keypad

S401 Thermal Mass Flow Meter (Insertion type)

Order No.	Description
Accessories	
A695 0008	S401: NPT½" thread adapter (former A1005)
A695 0009	S401: PT½" thread adapter (former A1006)
A553 0104	Sensor cable, 5 m with M12 connector, open wires, AWG 24 (0.2 mm ²)
A553 0105	Sensor cable, 10 m with M12 connector, open wires, AWG 24 (0.2 mm ²)
A553 0154	Cable to connect power bank, 1.8 m, USB-C connector for power bank, M12 connector

Example:

S401 220 mm shaft, Air, No 2nd Gas, Max range, Standard calibration, Isolated 4 ... 20 mA output, Display

Order Code:

S695 4100.A1007.A1003.A1401.A1409.A1410.A1420

Ordering

Please use the following tables to assist in placing your order with our sales staff.

S421 Thermal Mass Flow Meter (Inline type)

Order No.	Description
S695 4120	S421 Thermal Mass Flow Meter (Inline), 1.6 MPa
S695 4121	S421 Thermal Mass Flow Meter (Inline), 4.0 MPa
Measuring section connection *	
A130X	R-thread (ISO 7-1)
A132X	Flange, EN 1092-1, PN40
A134X	Flange ANSI 16.5
Measuring section size *	
1	DN15, ½"
2	DN20, ¾"
3	DN25, 1"
4	DN32, 1.25"
5	DN40, 1.5"
6	DN50, 2"
7	DN65, 2.5"
8	DN80, 3"
Flow Medium 1	
A1007	Option, flow medium Air
A1008	Option, flow medium CO ₂
A1009	Option, flow medium O ₂ (cleaning for oil and grease-free)
A1010	Option, flow medium N ₂
A1011	Option, flow medium N ₂ O
A1012	Option, flow medium Argon
A1013	Option, flow medium Natural Gas
A1014	Option, flow medium H ₂ (For real gas calibration. Please consult manufacturer for this option in advance)
A1015	Other gas (specify gas or gas mix)
A1016	Option, flow medium He (real gas calibration)
A1017	Option, flow medium Propane C ₃ H ₈
A1041	Option, flow medium O ₂ , Ar, CO ₂ (real gas calibration)
A1042	Option, flow medium CH ₄ , NG, N ₂ O (real gas calibration, please consult with manufacturer for this option in advance)
Flow Medium 2 (same selection as above)	
A1003	No 2nd Gas

S421 Thermal Mass Flow Meter (Inline type)

Order No.	Description
Range	
A1426	S421: Standard range version
A1403	S401/S421: Low range version (1/3 of standard range)
A1407	S401/S421: Vacuum / Atmospheric range (1/3 of standard range)
Calibration	
A1409	S401/S421: Standard calibration
A1404	S401/S421: High accuracy calibration (1 % ± 0.3 % F.S.)
Output	
A1410	Isolated 4 ... 20 mA + pulse output
A1411	Modbus/RTU output
A1413	S401/S421: 4 ... 20 mA + pulse output (pin compatible to S400 / 420)
A1424	Modbus/TCP output with PoE support
Display	
A1425	No Display
A1420	Color graphics display, 2.4" with keypad
Accessories	
A553 0104	Sensor cable, 5 m with M12 connector, open wires, AWG 24 (0.2 mm ²)
A553 0105	Sensor cable, 10 m with M12 connector, open wires, AWG 24 (0.2 mm ²)
A553 0154	Cable to connect power bank, 1.8 m, USB-C connector for power bank, M12 connector

Optional Flow Conditioner

Order No.	Dimensions	a	b in mm	c in mm
A1071	DN15	R 1/2"	24	64
A1072	DN20	R 3/4"	32	69
A1073	DN25	R 1"	37	75
A1074	DN32	R 1.25"	45	92
A1075	DN40	R 1.5"	54	92
A1076	DN50	R 2"	68	105
A1077	DN65	R 2.5"	80	128
A1078	DN80	R 3"	95	142

Example:

S421 1.6 MPa, R-thread DN50, CO₂, No 2nd Gas, Low Range Version, High Accuracy Calibration, Modbus/RTU, Display

Order Code:

S695 4120.A1306.A1008.A1003.A1403.A1404.A1411.A1420

S415

Compact Thermal Mass Flow Meter

Eco-Inline



COMPACT DESIGN

Can be installed anywhere



SMARTPHONE ANDROID APP

For remote configuration



POINT-OF-USE MEASUREMENT

Monitor machines and air consumers



TOTAL FLOW

No bypass measurement



ACCURATE RESULTS

Integrated flow conditioner



INTEGRATED DISPLAY

For on site values



Benefits

- ✔ Compact flow meter for installation directly at the point-of use
- ✔ Various process connection sizes available: DN8, DN15, DN20, DN25 and DN32 (G-inner-thread)
- ✔ Economic flow and consumption metering at low investments
- ✔ Machine operation costs and consumption monitoring
- ✔ Integrated flow conditioner eliminates the need of straight inlet sections

Cost-efficient Eco Version – Flexible Installation

The S415 Thermal Mass Flow Meters offers compressed air flow and consumption measurement directly at the point of use with seamless integration.

These highly economical units will help you improve compressed air system efficiency, while helping reduce compressed air usage and operating costs.

The S415 come standard with wireless communication interface to help the user quickly and easily check the flow meter readings or adjust the settings via the SUTO flow meter app.

Point of Use Applications

The S415 is best suited to general process work where low cost and broad monitoring of the compressed air flow is required.

Easily monitor the compressed air flow and consumption of individual machines and processes to improve efficiency and reliability.

Various Output Signals

Output	Connector	Pin 1	Pin 2	Pin 3	Pin 4
Modbus/RTU	A	D-	-VB	+VB	D+
	B	D-	GND	NA	D+
Analog and Pulse	A	I-	-VB	+VB	I+
	B	I-	P	P	I+
M-Bus	A	M-bus	-VB	+VB	M-bus
	B	M-bus	NA	NA	M-bus
Wire colour		brown	white	blue	black

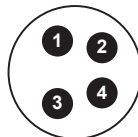

Pin assignment connector plug M8

- Every sensor includes 5m M8 cables with open ends
- Sensor with Modbus/RTU or M-Bus include 1 cable
- Sensors with Analog output include 2 cables

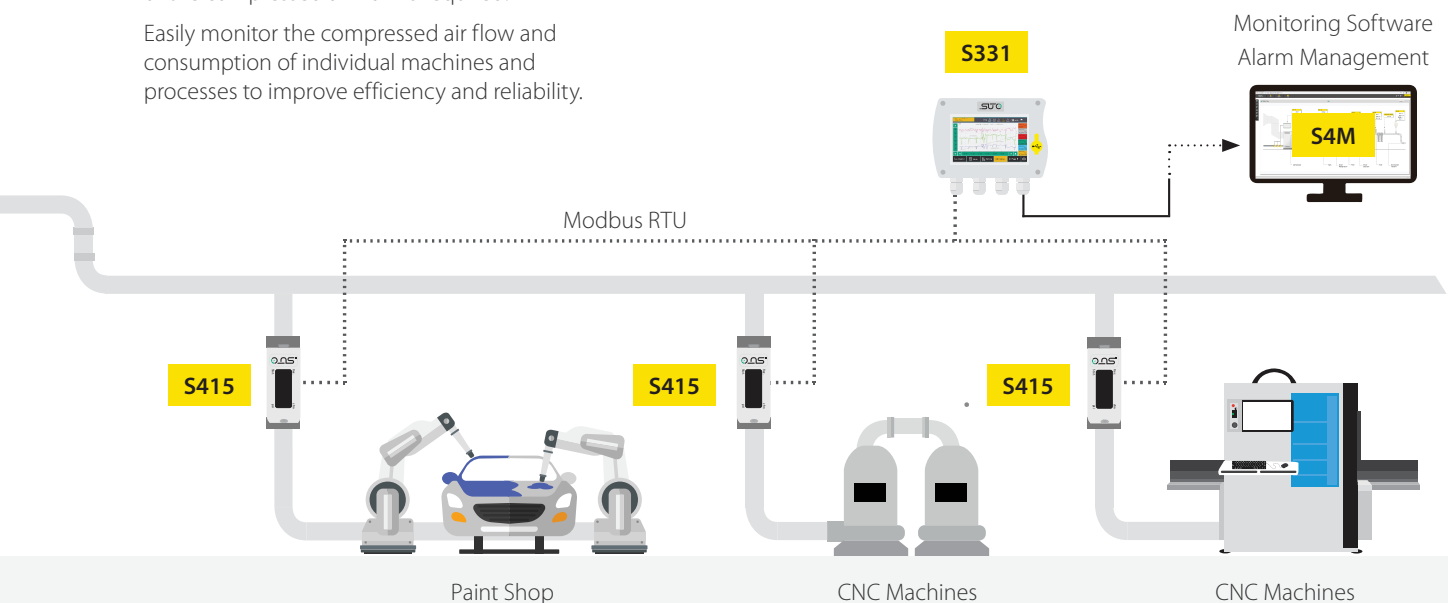

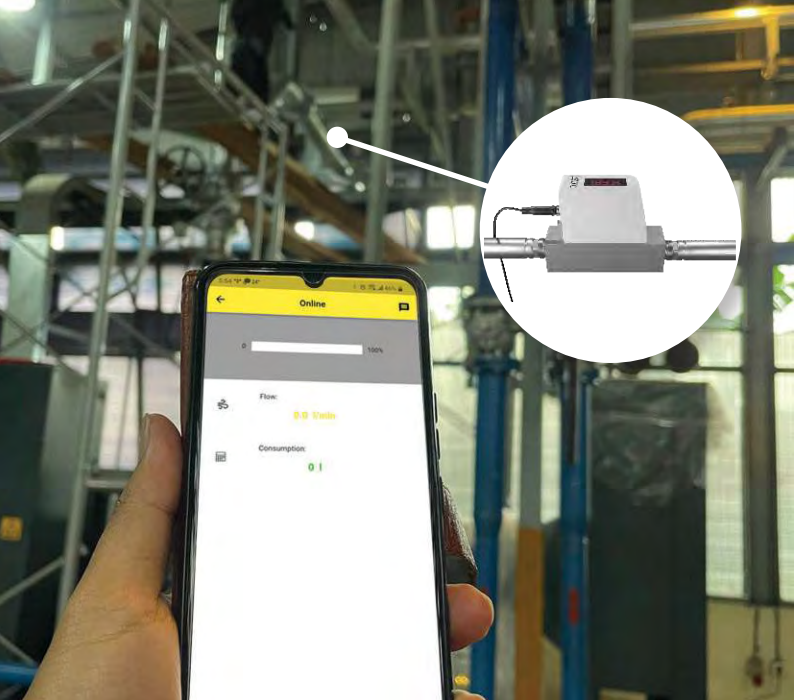

Wireless Connection

The free S4C-FS App offers a unique wireless connection to every SUTO flow meter for online readings and configuration.

Especially during installation and setup all settings can be performed using a smartphone, there is no need to carry a PC and an interface on site. This saves a lot of time and is the easy way to get reliable sensor readings.

Every sensor is protected by default. To perform changes on the flow meter, first a QR code must be scanned.

Flow Conditioner

Asymmetric velocity profiles, swirl, and other factors caused by bends in pipes can lead quickly to inaccurate readings. But sometimes there is not enough space to have straight inlet conditions for accurate readings.

The highly engineered flow conditioner solves this problem. Unlike a standard flow conditions disk, the 3D design of the flow conditioner allows measurements with no additional straight inlet piping at all. Thanks to the innovative mechanical design, the pressure loss is negligible small (<30 hPa), offering high accurate measurements in difficult pipe conditions.

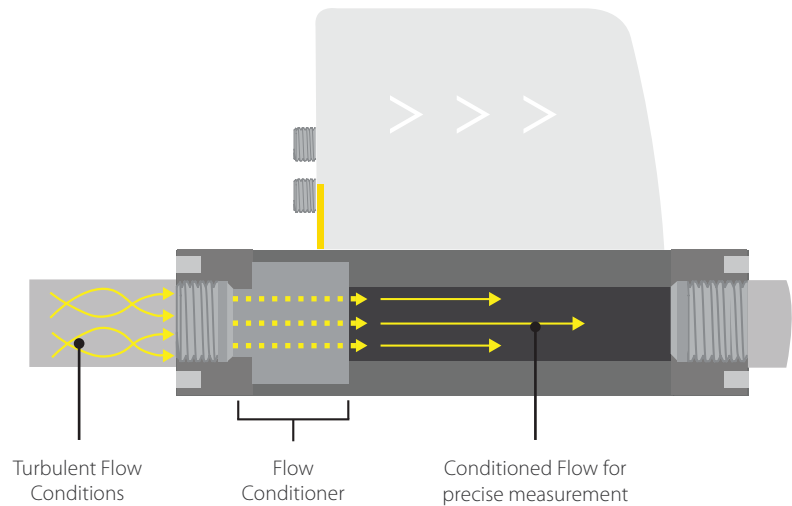

Connect several S415 to Modbus Master

The S415 with Modbus/RTU interface can be easily daisy-chained to a Modbus Master device such as S331 by using RS-485 splitter (A554 3310) and the M8 to M12 converter cable (A553 0161). Through this method you can add up to 16 flow meters to the master device

Remark: The S331 can maximum provide 10 W power to the connected devices. If more power is required a separate power supply is needed..



Display Direction

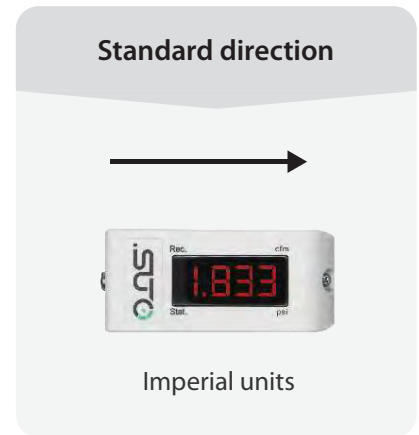
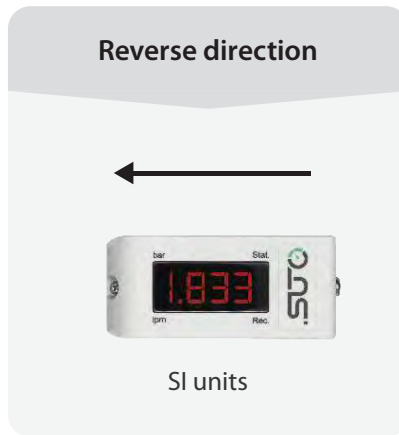

Measuring Range in Air (l/min)

Range	Standard Configuration				
Process connection	DN8	DN15	DN20	DN25	DN32
Standard range (S)	250	1000	2000	3500	6000
Low range (L)	50	200	400	700	1200

Stated measuring ranges for S415 under following conditions:

- Standard flow in air in l/min
- Reference pressure: 1000 mbar
- Reference Temperature: +20 °C

Measuring ranges in Nitrogen are different. Please contact us for details at sales@suto-itec.com



Dimensions

Dimensions in mm	a	b	c	d	e
DN8/DN15	35.0	93.0	120.4	35.0	48.0
DN20/DN25	48.0	106.0	178.0	48.0	61.0
DN32	60.0	118.0	222.0	60.0	73.0

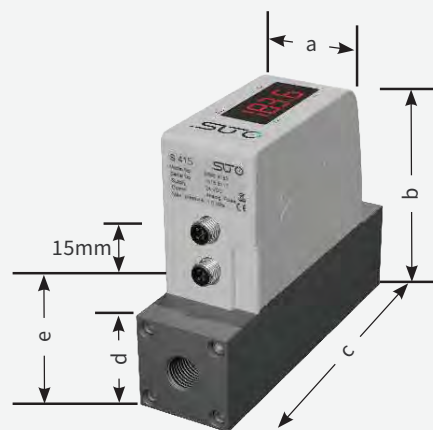

Technical Data

Measurement

Flow

Accuracy	3 % o.RDG \pm 0.3 % FS
Selectable units	l/min, cfm, kg/h, m ³ /h
Measuring range	see table on the previous page
Repeatability	1 % o.RDG
Sensor	Thermal mass flow sensor
Sampling rate	3/sec
Turndown ratio	50:1
Response time (t90)	2 sec

Consumption

Selectable units	m ³ , ft ³ , l, kg
------------------	--

Reference conditions

Selectable conditions	20 °C 1000 mbar (ISO1217) 0 °C 1013 mbar (DIN1343) freely adjustable
-----------------------	--

Signal / Interface & Supply

Analog output

Signal	4 ... 20 mA, isolated
Scaling	0 ... max flow
Load	250R
Update rate	3/sec

Pulse output

Signal	Max 30 V, 200 mA
Scaling	1 pulse per consumption unit

Fieldbus

Interface/Protocol	RS-485/Modbus/RTU M-Bus
--------------------	----------------------------

Supply

Voltage supply	15 ... 30 VDC
Current consumption	120 mA @ 24 VDC

General data

Configuration

Wireless	S4C-FS App for mobile phones
----------	------------------------------

Display

Integrated	4 digit LED
------------	-------------

Material

Process connection	Aluminum alloy
--------------------	----------------

Housing	PC + ABS
---------	----------

Sensor	Glass coated resistive sensor
--------	-------------------------------

Metal parts	Aluminum alloy
-------------	----------------

Miscellaneous

Electrical connection	2 x M8 (4 pole)
-----------------------	-----------------

Protection class	IP54
------------------	------

Approvals	CE, RoHS, FCC
-----------	---------------

Process connection	G-thread
--------------------	----------

Weight	0.45 ... 1.3 kg (depends on model)
--------	------------------------------------

Operating conditions

Medium	Air, N ₂
--------	---------------------

Medium quality	ISO 8573: 4.4.3 or better
----------------	---------------------------

Medium temperature	0 ... 50 °C
--------------------	-------------

Medium humidity	< 90 % rH, no condensation
-----------------	----------------------------

Operating pressure	0 ... 10 bar(g)
--------------------	-----------------

Ambient temperature	0 ... 50 °C
---------------------	-------------

Ambient humidity	< 95 % rH
------------------	-----------

Storage temperature	-30 ... 70 °C
---------------------	---------------

Transport temperature	-30 ... 70 °C
-----------------------	---------------

Pipe sizes	DN8, DN15, DN20, DN25, DN32
------------	-----------------------------

Ordering

Please use the following tables to assist in placing your order with our sales staff.

S415 Compact Thermal Mass Flow Meter (Inline)

Order No.	Description
S695 415	S415 Compact Thermal Mass Flow Meter, G inner thread, 24 VDC, 5 m cable with M8 connector and open ends included
Size	
S695 4150	DN8
S695 4151	DN15
S695 4152	DN20
S695 4153	DN25
S695 4154	DN32
Range	
A1464	Standard range version
A1453	Low range version
Output	
A1450	Analog 4 ... 20 mA, Pulse Output
A1451	Modbus/RTU output
A1452	M-Bus output
Gas type	
A1007	Air
A1010	N ₂
Units	
A1466	With SI units
A1458	With imperial units
Display direction	
A1462	Standard display direction (left to right)
A1460	Reverse display direction
Example:	S415 DN15, Standard Range, Modbus/RTU, Air, SI units, Standard Display direction
Order Code:	S695 4151.A1464.A1451.A1007.A1466.A1462

S415 Accessories

Order No.	Description
A554 0109	Mains power supply 100-240 VAC / 24 VDC, 0.5 A, 2 m cable with M8 connector
A553 0137	Connection cable to S551, 5 m
A553 0161	M8 to M12 converter cable for Modbus splitter
A553 0171	Cable to connect power bank, 1.8 m, USB-C connector for power bank, M8 connector
A554 3310	RS-485 / Modbus splitter

Mobile Power

S415 powered by power bank with connection cable A553 0171

Note: power bank must be sourced locally due to shipping restrictions [USB-C, 20 V, min. 100 mA]



S418

Compact Thermal Mass Flow Meter

Pro-Inline



SMARTPHONE ANDROID APP
For remote configuration



POINT-OF-USE MEASUREMENT
Monitor machines and air consumers



COMPACT DESIGN
Can be installed anywhere



TOTAL FLOW
No bypass measurement

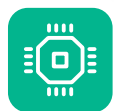

EASY PROCESS MONITORING
Effective and inexpensive recording



ACCURATE RESULTS
Integrated flow conditioner



Benefits

- ✔ Highly versatile flow and consumption meter for compressed air and technical gases
- ✔ Integrated pressure sensor optional
- ✔ Integrated data logger for measurement recordings as standard feature
- ✔ Various process connection sizes available: DN8, DN15, DN20, DN25 and DN32 (G-inner-thread)
- ✔ Accurate monitoring of gas supplies and consumers
- ✔ Integrated flow conditioner eliminates the need of straight inlet sections

Powerful Pro Version – Flexible Installation

The S418 Thermal Mass Flow Meters offers compressed air flow and gas measurement directly at the point of use.

It comes standard with wireless communication interface to help the user quickly and easily check the flow meter readings or adjust the settings via the SUTO flow meter app.

Improve your compressed air system efficiency, while helping reduce compressed air and gas usage and operating costs by monitoring:

- Flow and Consumption
- Pressure
- Temperature

Connection

Pin assignment connector plug M8

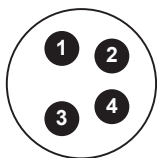

- Every sensor includes 5m M8 cables with open ends
- Sensor with Modbus/RTU or M-Bus include 1 cable
- Sensors with Analog output include 2 cables

Output	Connector	Pin 1	Pin 2	Pin 3	Pin 4
Modbus/RTU	A	D-	-VB	+VB	D+
	B	D-	GND	NA	D+
Analog and Pulse	A	I-	-VB	+VB	I+
	B	I-	P	P	I+
M-Bus	A	M-bus	-VB	+VB	M-bus
	B	M-bus	NA	NA	M-bus
Wire colour		brown	white	blue	black

Gas Monitoring Application

The S418 is ideal for remote locations or high accuracy compressed air flow and gas measurements with its built-in data logger and optional pressure sensing.

The compact flow meters provide accurate gas flow monitoring, helping to discover weak points in the process flow, thus ensuring continuity and profitability.

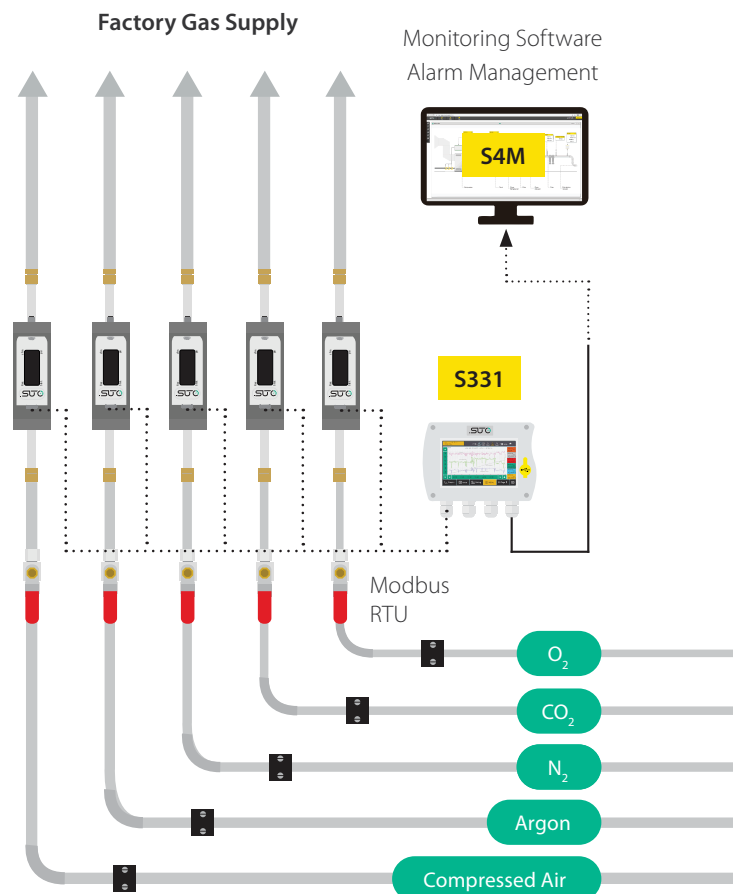



Wireless Connection

The free S4C-FS App offers a unique wireless connection to every SUTO flow meter for online readings and configuration.

Especially during installation and setup all settings can be performed using a smartphone, there is no need to carry a PC and an interface on site. This saves a lot of time and is the easy way to get reliable sensor readings.

Every sensor is protected by default. To perform changes on the flow meter, first a QR code must be scanned.

Flow Conditioner

Asymmetric velocity profiles, swirl, and other factors caused by bends in pipes can lead quickly to inaccurate readings. But sometimes there is not enough space to have straight inlet conditions for accurate readings.

The highly engineered flow conditioner solves this problem. Unlike a standard flow conditions disk, the 3D design of the flow conditioner allows measurements with no additional straight inlet piping at all. Thanks to the innovative mechanical design, the pressure loss is negligible small (<30 hPa), offering high accurate measurements in difficult pipe conditions.

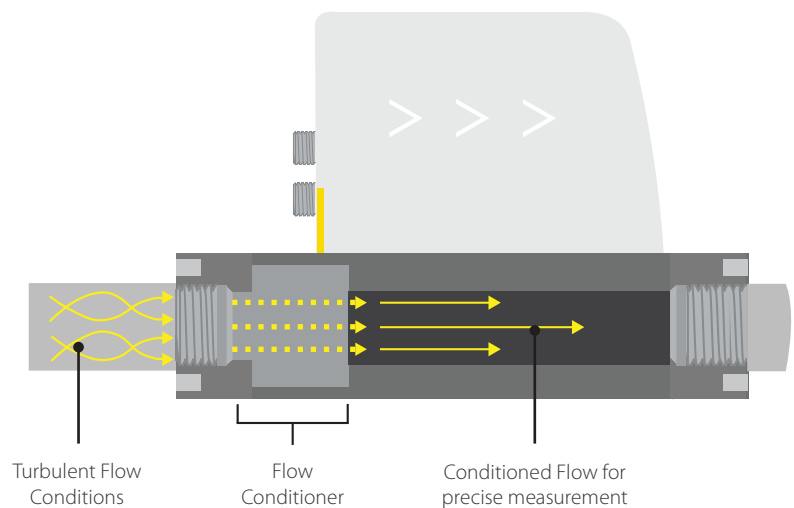

Connect several S418 to Modbus Master

The S418 with Modbus/RTU interface can be easily daisy-chained to a Modbus Master device such as S331 by using RS-485 splitter (A554 3310) and the M8 to M12 converter cable (A553 0161). Through this method you can add up to 16 flow meters to the master.

Remark: The S331 can maximum provide 10 W power to the connected devices. If more power is required a separate power supply is needed..

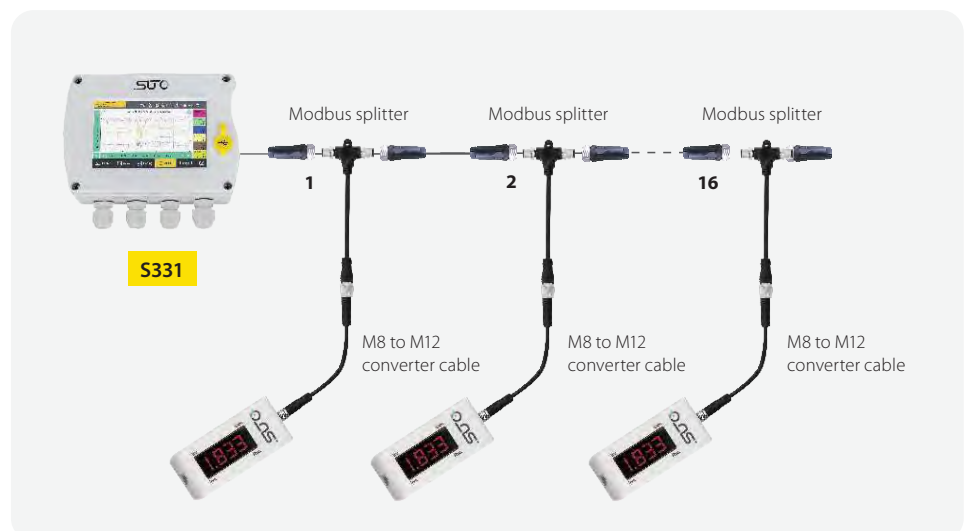

Display Direction

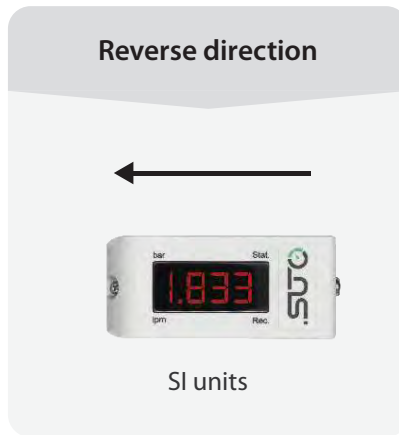

Measuring Range in Air (l/min)

Range	Standard Configuration				
Process connection	DN8	DN15	DN20	DN25	DN32
Standard range (S)	250	1000	2000	3500	6000
Low range (L)	50	200	400	700	1200

Stated measuring ranges for S418 under following conditions:

- Standard flow in air in l/min
- Reference pressure: 1000 mbar
- Reference Temperature: +20 °C

Measuring ranges in Nitrogen are different. Please contact us for details at sales@suto-itec.com



Dimensions

Dimensions in mm	a	b	c	d	e
DN8/DN15	35.0	93.0	120.4	35.0	48.0
DN20/DN25	48.0	106.0	178.0	48.0	61.0
DN32	60.0	118.0	222.0	60.0	73.0



Technical Data

Measurement

Flow

Accuracy	1.5 % o.RDG \pm 0.3 % FS
Selectable units	l/min, cfm, kg/h, m ³ /h
Measuring range	see table on the previous page
Repeatability	0.5 % o.RDG
Sensor	Thermal mass flow sensor
Sampling rate	10/sec
Turndown ratio	100:1
Response time (t90)	0.5 sec

Consumption

Selectable units	m ³ , ft ³ , l, kg
------------------	--

Pressure

Accuracy	0.5 % FS
Selectable units	bar, psi
Measuring range	0 ... 10 bar(g)
Sensor	Piezo resistive sensor

Reference conditions

Selectable conditions	20 °C 1000 mbar (ISO1217), 0 °C 1013 mbar (DIN1343) freely adjustable
-----------------------	---

Signal / Interface & Supply

Analog output

Signal	4 ... 20 mA (4-wire), isolated
Scaling	0 ... max flow
Load	Max 250 Ω freely adjustable
Update rate	3/sec

Pulse output

Signal	Switch output, normally open, max 30 VDC, 200 mA
Scaling	1 pulse per consumption unit

Fieldbus

Protocol	Modbus/RTU
----------	------------

Supply

Voltage supply	15 ... 30 VDC
Current consumption	120 mA @ 24 VDC

Data interface

Connection	USB micro
------------	-----------

General data

Configuration

Wireless	S4C-FS App for mobile phones
PC Software	S4A PC software for download and data analyzes

Display

Integrated	4 digit LED
------------	-------------

Data Logger

Storage	8 Mio. values
---------	---------------

Material

Process connection	Aluminum alloy
Housing	PC + ABS
Sensor	Ceramic, glass coated
Metal parts	Aluminum alloy

Miscellaneous

Electrical connection	2 x M8 (4 pole)
Protection class	IP54
Approvals	CE, RoHS, FCC
Process connection	G-thread
Weight	0.45 ... 1.3 kg (depends on model)

Operating conditions

Medium	Air, N ₂ , O ₂ , CO ₂ and other gases
Medium quality	ISO 8573: 4.4.3 or better
Medium temperature	0 ... 50 °C
Medium humidity	< 90 % rH, no condensation
Operating pressure	0 ... 10 bar(g)
Ambient temperature	0 ... 50 °C
Ambient humidity	< 95 % rH
Storage temperature	-30 ... 70 °C
Transport temperature	-30 ... 70 °C
Pipe sizes	DN8, DN15, DN20, DN25, DN32

Ordering

Please use the following tables to assist in placing your order with our sales staff.

S418 Compact Thermal Mass Flow Meter (Pro-Inline)

Order No.	Description
S695 418	S418 Compact Thermal Mass Flow Meter with integrated data logger, G inner thread, 24 VDC, 5 m cable with M8 connector and open ends included
Size + Pressure sensor option	
S695 4180	DN8
S695 4181	DN15
S695 4182	DN20
S695 4183	DN25
S695 4184	DN32
S695 4185	DN8, Pressure sensor 10 bar(g)
S695 4186	DN15, Pressure sensor 10 bar(g)
S695 4187	DN20, Pressure sensor 10 bar(g)
S695 4188	DN25, Pressure sensor 10 bar(g)
S695 4189	DN32, Pressure sensor 10 bar(g)
Range	
A1465	Standard range version
A1453	Low range version
Output	
A1455	S418: Analog 4 ... 20 mA, Pulse output
A1456	S418: Modbus/RTU output
A1457	S418: M-Bus output
Fluid Medium 1	
A1007	Air
A1008	CO ₂
A1009	O ₂ (Oil- & grease-free cleaned)
A1010	N ₂
A1011	N ₂ O
A1012	Argon
A1013	Natural Gas
A1014	H ₂ (Real gas calibration)
A1015	Other Gas (Please specify)
A1016	He (Real gas calibration)
A1017	C ₃ H ₈
Fluid Medium 2 (same selections as above)	
A1003	No 2nd Gas
Units	
A1467	With SI units
A1459	With imperial units
Display direction	
A1463	Standard display direction (left to right)
A1461	Reverse display direction

Example: S418 DN25, Low Range, Modbus/RTU, Air, No 2nd Gas, SI units, Standard Display direction

Order Code: S695 4183.A1453.A1456.A1007.A1003.A1467.A1463

S418 Accessories

Order No.	Description
A554 0109	Mains power supply 100-240 VAC / 24 VDC, 0.5 A, 2 m cable with M8 connector
A553 0137	Connection cable to S551, 5 m
M599 7020	S4A data analysis software, for data logger S418
A553 0161	M8 to M12 converter cable for Modbus splitter
A553 0171	Cable to connect power bank, 1.8 m, USB-C connector for power bank, M8 connector
A554 3310	RS-485 / Modbus splitter

Mobile Power

S418 powered by power bank with connection cable A553 0171

Note: power bank must be sourced locally due to shipping restrictions [USB-C, 20 V, min. 100 mA]



S418-V

Compact Thermal Mass Flow Meter for Vacuum Applications

Pro-Inline



**SMARTPHONE
ANDROID APP**
For remote
configuration



**POINT-OF-USE
MEASUREMENT**
Monitoring of
vacuum pumps



**COMPACT
DESIGN**
Can be installed any-
where



**TOTAL
FLOW**
No bypass
measurement

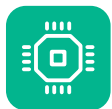

**EASY PROCESS
MONITORING**
Effective and
inexpensive
recording



**ACCURATE
RESULTS**
Integrated flow
conditioner



Benefits

- ✔ Highly economical point-of-use flow and consumption measurements at the low pressure side of vacuum pumps
- ✔ Integrated data logger for measurement recordings as standard feature
- ✔ Various process connection sizes available: DN8, DN15, DN20 and DN25 (G-inner-thread)
- ✔ Absolute pressure sensor integrated for actual vacuum flow measurements
- ✔ Integrated flow conditioner eliminates the need of straight inlet sections
- ✔ Optional integrated pressure sensor

Optimize Your Vacuum System Efficiency

The S418-V Compact Thermal Mass Flow Meter offers a simple but effective monitoring solution for vacuum applications at the point-of use.

It comes standard with wireless communication interface to help the user quickly and easily check the flow meter readings or adjust the settings via the SUTO flow meter app.

Improve your vacuum system efficiency, while helping to reduce operating costs by monitoring:

- Flow and Consumption
- Pressure
- Temperature

Various Output Signals

Output	Connector	Pin 1	Pin 2	Pin 3	Pin 4
Modbus/ RTU	A	D-	-VB	+VB	D+
	B	D-	GND	NA	D+
Analog and Pulse	A	I-	-VB	+VB	I+
	B	I-	P	P	I+
M-Bus	A	M-bus	-VB	+VB	M-bus
	B	M-bus	NA	NA	M-bus
Wire colour		brown	white	blue	black

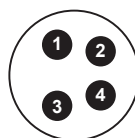

Pin assignment connector plug M8

- Every sensor includes 5m M8 cables with open ends
- Sensor with Modbus/RTU or M-Bus include 1 cable
- Sensors with Analog output include 2 cables

Vacuum Applications

S418-V is used for performance monitoring of vacuum pumps. Equipped with an absolute pressure sensor, it does not only show the vacuum pressure, but also shows the actual vacuum flow. These parameters are most the critical values in vacuum applications and help operators to ensure their process reliability.

Monitoring Software
Alarm Management

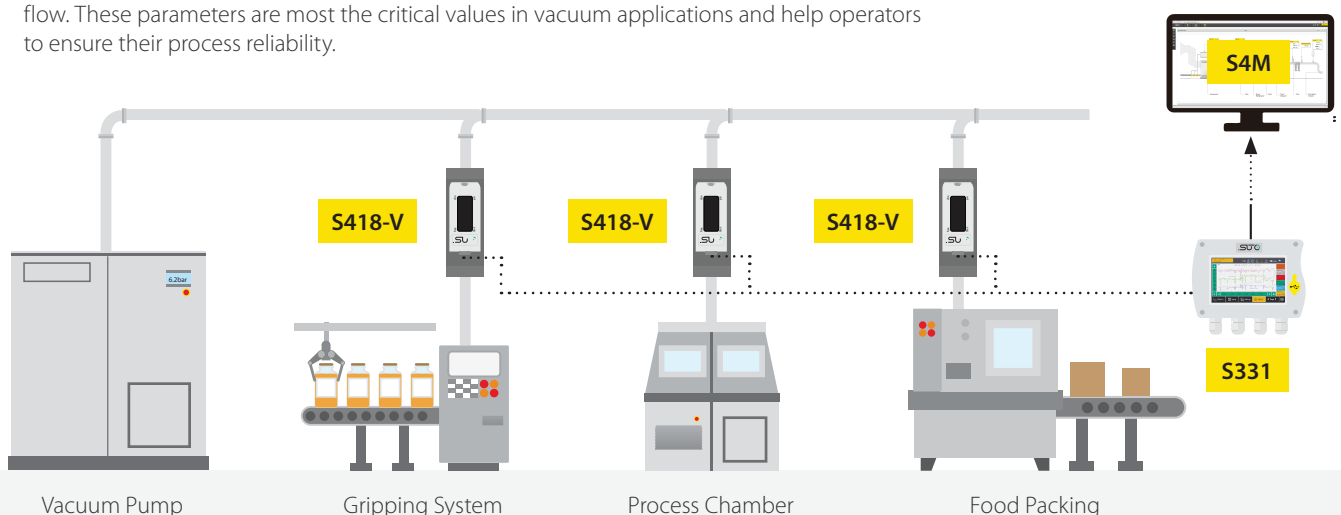



Wireless Connection

The free S4C-FS App offers a unique wireless connection to every SUTO flow meter for online readings and configuration.

Especially during installation and setup all settings can be performed using a smartphone, there is no need to carry a PC and an interface on site. This saves a lot of time and is the easy way to get reliable sensor readings.

Every sensor is protected by default. To perform changes on the flow meter, first a QR code must be scanned.

Flow Conditioner

Asymmetric velocity profiles, swirl, and other factors caused by bends in pipes can lead quickly to inaccurate readings. But sometimes there is not enough space to have straight inlet conditions for accurate readings.

The highly engineered flow conditioner solves this problem. Unlike a standard flow conditions disk, the 3D design of the flow conditioner allows measurements with no additional straight inlet piping at all. Thanks to the innovative mechanical design, the pressure loss is negligible small (<30 hPa), offering high accurate measurements in difficult pipe conditions.

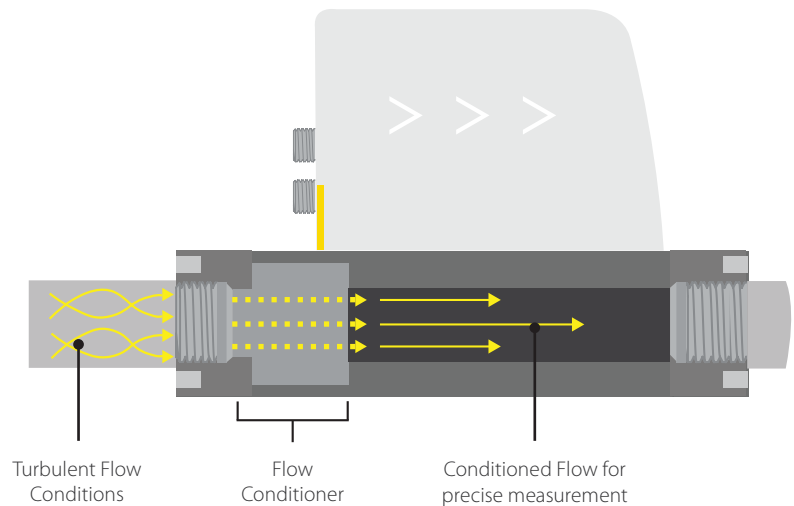

Connect several S418-V to Modbus Master

The S418-V with Modbus/RTU interface can be easily daisy-chained to a Modbus Master device such as S331 by using RS-485 splitter (A554 3310) and the M8 to M12 converter cable (A553 0161). Through this method you can add up to 16 flow meters to the master

Remark: The S331 can maximum provide 10 W power to the connected devices. If more power is required a separate power supply is needed..

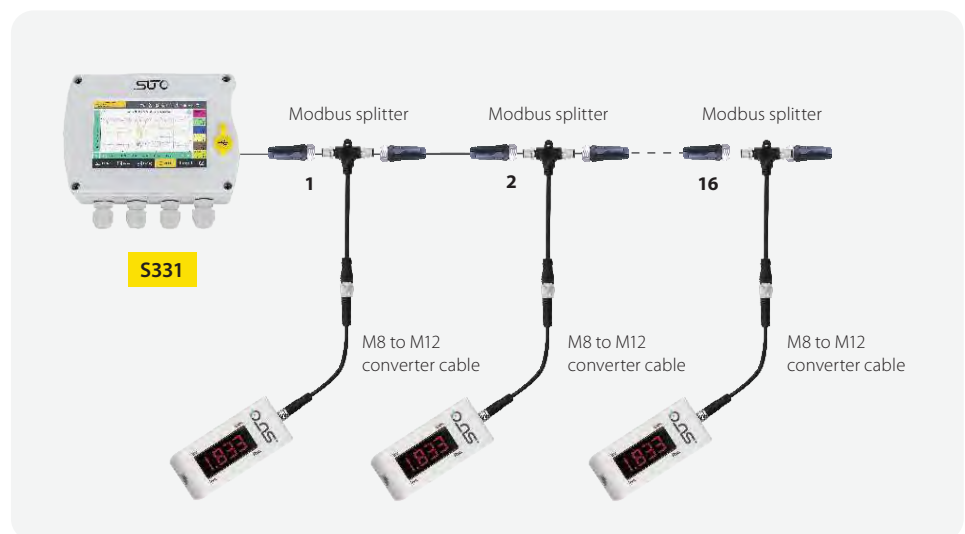

Display Direction

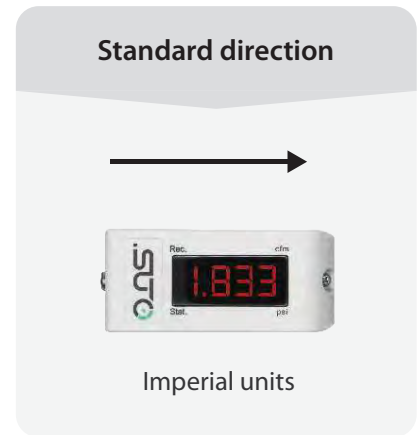
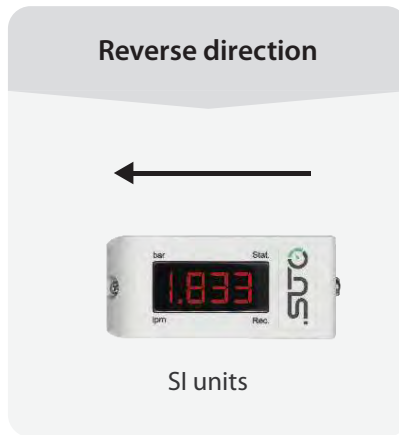

Measuring Range in Air (l/min)

Range	Standard Configuration				
Process connection	DN8	DN15	DN20	DN25	Absolute Pressure (mbar)
Vacuum flow in l/min	56	222	444	778	900
	63	250	500	875	800
	71	286	571	1000	700
	83	333	667	1167	600
	100	400	800	1400	500
	125	500	1000	1750	400
	167	557	1333	2333	300
	250	1000	2000	3500	200
	500	2000	4000	7000	100

Stated measuring ranges for S418-V under following conditions:

- Standard flow in air in l/min
- Reference pressure: 1000 mbar
- Reference Temperature: +20 °C



DN20, DN25



Dimensions

Dimensions in mm	a	b	c	d	e
DN8/DN15	35.0	93.0	120.4	35.0	48.0
DN20/DN25	48.0	106.0	178.0	48.0	61.0

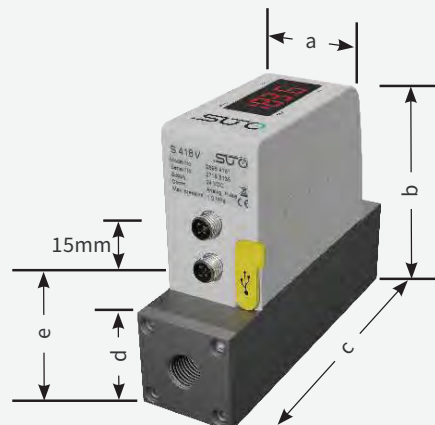

Technical Data

Measurement

Flow

Accuracy	1.5 % of reading \pm 0.3 % FS
Selectable units	m ³ /h, l/min, cfm, kg/h
Measuring range	see table on the previous page
Repeatability	0.5 % of reading
Sensor	Thermal mass flow sensor
Sampling rate	10 samples / sec
Turndown ratio	1:100
Response time (t90)	0.5 sec

Consumption

Selectable units	m ³ , ft ³ , l, kg
------------------	--

Pressure

Accuracy	0.5 % FS
Selectable units	bar, psi
Measuring range	0.01 ... 1.6 bar(a)
Sensor	Piezo resistive sensor

Reference conditions

Selectable conditions	20 °C 1000 mbar (ISO1217)
-----------------------	---------------------------

Signal / Interface & Supply

Analog output

Signal	4 ... 20 mA (4-wire), isolated
Scaling	0 ... max flow, freely adjustable
Load	max. 250 Ohm
Update rate	3/sec

Pulse output

Signal	Switch output, normally open, max. 30 VDC, 200 mA
Scaling	1 pulse per consumption unit

Fieldbus

Protocol	Modbus/RTU
----------	------------

Supply

Voltage supply	15 ... 30 VDC
Current consumption	120 mA @ 24 VDC

Data interface

Connection	USB micro
------------	-----------

General data

Configuration

Wireless	S4C-FS App for mobile phones
PC Software	S4A PC software for data analyzes

Display

Integrated	4 digit LED
------------	-------------

Data Logger

Storage	8 Mio. values
---------	---------------

Material

Process connection	Aluminum alloy
Housing	PC + ABS
Sensor	Ceramic, glass coated
Metal parts	Aluminum alloy

Miscellaneous

Electrical connection	2 x M8 (4 pole)
Protection class	IP54
Approvals	CE, RoHS, FCC
Process connection	G-thread
Weight	0.45 ... 1.1 kg (depends on model)

Operating conditions

Medium	Air, N ₂ , O ₂ , CO ₂ and other gases
Medium quality	ISO 8573: 4.4.3 or better
Medium temperature	0 ... 50 °C
Medium humidity	< 90 % rH, no condensation
Operating pressure	Max. 10 bar(g)
Ambient temperature	0 ... 50 °C
Ambient humidity	< 95 % rH
Storage temperature	-30 ... 70 °C
Transport temperature	-30 ... 70 °C
Pipe sizes	DN8, DN15, DN20, DN25

Vacuum Scales

bar(a)	inch Hg(g)	kPa(g)	bar(g)	mbar(a)
1.00	0.00	0	0.00	1000
0.90	-2.95	-10	-0.10	900
0.80	-5.91	-20	-0.20	800
0.70	-8.86	-30	-0.30	700
0.60	-11.81	-40	-0.40	600
0.50	-14.77	-50	-0.50	500
0.40	-17.72	-60	-0.60	400
0.30	-20.67	-70	-0.70	300
0.20	-23.63	-80	-0.80	200
0.10	-26.58	-90	-0.90	100
0.01	-29.24	-99	-0.99	10

Ordering

Please use the following tables to assist in placing your order with our sales staff.

S418-V Compact Thermal Mass Flow Meter for Vacuum Applications (Inline)

Order No.	Description
S695 419	S418-V, Vacuum Flow Meter, with integrated absolute pressure sensor, G inner thread, 24 VDC, 5 m cable with M8 connector and open ends included

Size	
S695 4190	DN8
S695 4191	DN15
S695 4192	DN20
S695 4193	DN25

Output	
A1455	S418: Analog 4 ... 20 mA, Pulse output
A1456	S418: Modbus/RTU output
A1457	S418: M-Bus output

Units	
A1467	With SI units
A1459	With imperial units

Display direction	
A1463	Standard display direction (left to right)
A1461	Reverse display direction

Example: S418-V DN20, Modbus/RTU, SI units, Standard Display direction

Order Code: S695 4192.A1456.A1467.A1463

S418-V Accessories

Order No.	Description
A554 0109	Mains power supply 100-240 VAC / 24 VDC, 0.5 A, 2 m cable with M8 connector
A553 0137	Connection cable to S551, 5 m
M599 7020	S4A data analysis software, for data logger S418-V
A554 3310	RS-485 / Modbus splitter
A553 0161	M8 to M12 converter cable for Modbus splitter
A553 0171	Cable to connect power bank, 1.8 m, USB-C connector for power bank, M8 connector

Mobile Power

S418-V powered by power bank with connection cable A553 0171

Note: power bank must be sourced locally due to shipping restrictions [USB-C, 20 V, min. 100 mA]



S450 / S452

Thermal Mass Flow Meter for Heavy Duty and Ex Applications

Insertion / Inline



S452

S450



INDUSTRIAL DESIGN
For outdoor applications



WIRELESS INTERFACE
User friendly sensor settings



NO MECHANICAL WEAR PARTS
Independent of pressure and temperature



EXPLOSION PROOF
Use in Ex-area applications



EASY TO CLEAN
All wetted parts stainless steel



ACCURATE RESULTS
Very fast response time



Benefits

- ✓ Robust metal enclosure suitable for outdoor applications in harsh environment
- ✓ All parts which come into contact with the measurement medium are made of stainless steel 316L
- ✓ No moving parts, non clogging
- ✓ Direct measurement of mass flow and standard flow without the need of pressure compensation
- ✓ Low maintenance costs due to stable and reliable measurements

1 Robust Materials

- The IP67 housing allows applications in harsh industrial environment as well as outdoor applications.
- All parts which come into contact with the measurement medium are made of stainless steel 316L. This makes the sensors robust and guarantees a reliable measurement.

2 Display

- The display shows all relevant measured values on site. This allows the user to install the flowmeter easily and quickly.
- The pressure-tight encapsulation protects the display from external influences and ensures that it is always clearly visible.

3 Flexible and easy Installation

Wide range of tube sizes are supported with insertion type for big pipe diameters and inline types for small pipe diameters.

4 Outputs

S450 and S452 offer different signal outputs for flexible installation. Analog 4 ... 20 mA 2/3-wire, pulse; Modbus/RTU; HART



Applications

- ✓ Flow measurement in hazardous and all wetter applications
- ✓ Explosive and harsh environments
- ✓ Pharmaceutical and food industry
- ✓ Various Gas Measurement such as oxygen, argon, carbon dioxide, natural gas, hydrogen, methane, etc..

Installation



S450

Insertion type installation through ball valve



S452

Inline type installation through flanges or R thread

Available Options

- ✓ Fieldbus interface: HART, M-Bus und Modbus/RTU
- ✓ Ex-Approvals:
 - IECEx
 - GB Ex
- ✓ Bi-directional measurement
- ✓ Flow conditioner for R-thread measuring sections

Rotation

Sensor head can be rotated in 90° steps through the screw nut. This allows the display to be turned into the best viewing position.



Industrial Communication

Industrial communication through Modbus/RTU, M-Bus, HART

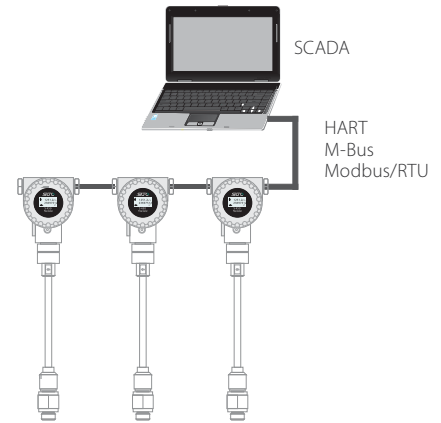

Volumetric Flow Ranges

Tube		S450 Volumetric Flow Ranges		
Inch	DN	S-Range (m³/h)	M-Range (m³/h)	HS-Range (m³/h)
½"	DN15	0.2 ... 45.6	0.4 ... 91.0	0.48 ... 110
¾"	DN20	0.4 ... 89.1	0.9 ... 178	1.09 ... 215
1"	DN25	0.6 ... 148	1.2 ... 295	1.82 ... 357
1½"	DN40	1.5 ... 367	2.9 ... 732	4.36 ... 886
2"	DN50	2.4 ... 600	4.8 ... 1,198	7.26 ... 1,450
2½"	DN65	4.1 ... 1,027	8.2 ... 2,049	12.1 ... 2,480
3"	DN80	5.7 ... 1,424	11.4 ... 2,841	16.9 ... 3,442
4"	DN100	8.7 ... 2,183	17.4 ... 4,357	24.2 ... 5,275
5"	DN125	20 ... 3,419	38 ... 6,824	45.9 ... 8,263
6"	DN150	20 ... 4,930	39 ... 9,839	70.18 ... 11,913
8"	DN200	35 ... 8,786	70 ... 17,533	106.48 ... 21,229
10"	DN250	55 ... 13,744	110 ... 27,429	165.77 ... 33,210
12"	DN300	79 ... 19,815	158 ... 39,544	239.58 ... 47,880

Tube		S452 Volumetric Flow Ranges		
Inch	DN	S-Range (m³/h)	M-Range (m³/h)	HS-Range (m³/h)
½"	DN15	0.2 ... 45.6	0.4 ... 91.0	0.48 ... 110
¾"	DN20	0.4 ... 89.1	0.9 ... 178	1.09 ... 215
1"	DN25	0.6 ... 148	1.2 ... 295	1.82 ... 357
1½"	DN40	1.5 ... 367	2.9 ... 732	4.36 ... 886
2"	DN50	2.4 ... 600	4.8 ... 1,198	7.26 ... 1,450
2½"	DN65	4.1 ... 1,027	8.2 ... 2,049	N/A
3"	DN80	5.7 ... 1,424	11.4 ... 2,841	N/A

Stated measuring ranges under following conditions:

- Standard flow in air
- Reference pressure: 1000 hpa reference temperature: +20 °c
- At other standard conditions and in other gases Flow ranges are different and data are available on request.
- In larger pipe diameters flow can also be measured.

S450 Dimensions

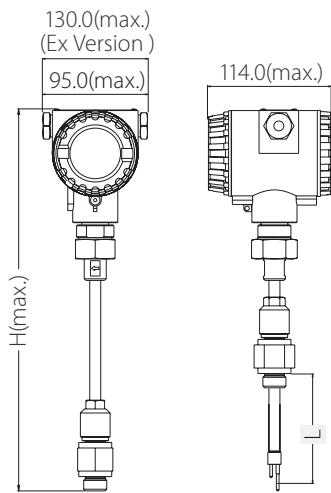

Shaft option	L (mm)	H (mm)
A	220	469
B	160	409
C	300	549

S452 Dimensions (Thread Type)

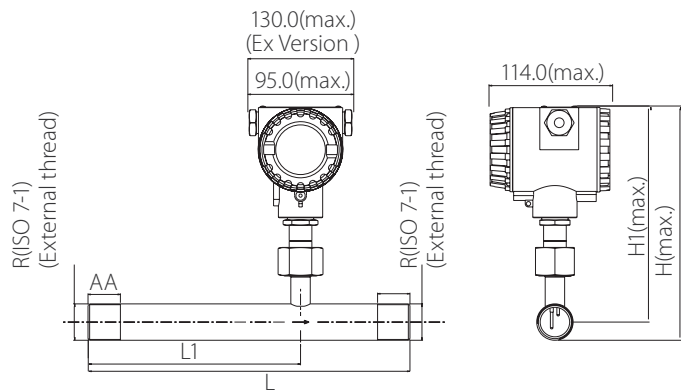

Pipe nominal size inch / (DN)	L total length (mm)	L1 inlet length (mm)	H total height (mm)	H1 pipe center to top (mm)	R External Thread
1/2" (DN15)	300	210	210.8	200.15	R 1/2"
3/4" (DN20)	475	275	213.6	200.15	R 3/4"
1" (DN25)	475	275	217.0	200.15	R 1"
1 1/4" (DN32)	475	275	221.35	200.15	R 1 1/4"
1 1/2" (DN40)	475	275	224.3	200.15	R 1 1/2"
2" (DN50)	475	275	230.3	200.15	R 2"
2 1/2" (DN65)	475	275	246.15	208.15	R 2 1/2"
3" (DN80)	475	275	259.15	214.65	R 3"

S452 Dimensions (Flange Type)

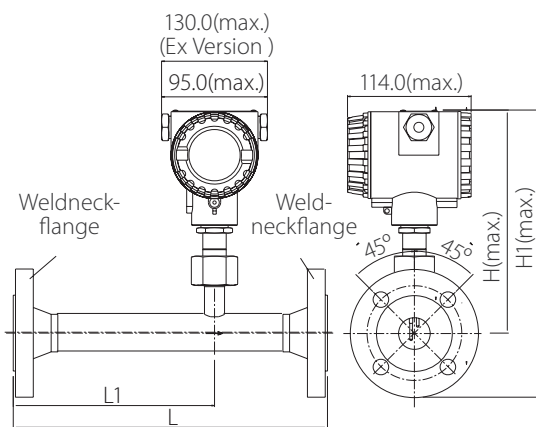

Pipe nominal size inch / (DN)	L total length (mm)	L1 inlet length (mm)	H total height (mm)	H1 pipe center to top (mm)
1/2" (DN15)	300	210	247.65	200.15
3/4" (DN20)	475	275	252.65	200.15
1" (DN25)	475	275	257.65	200.15
1 1/4" (DN32)	475	275	270.15	200.15
1 1/2" (DN40)	475	275	275.15	200.15
2" (DN50)	475	275	282.65	200.15
2 1/2" (DN65)	475	275	300.55	208.05
3" (DN80)	475	275	314.45	214.45

Technical Data

Measurement

Flow

Accuracy	±(1.5 % of reading + 0.3 % full scale)
Selectable units	m ³ /h, m ³ /min, l/min, l/s, cfm, kg/h, kg/min, kg/s
Repeatability	0.25 % o.RDG
Sensor	Thermal mass flow sensor
Sampling rate	3 samples / sec
Turndown ratio	200:1
Response time (t90)	0.5 sec

Consumption

Selectable units	m ³ , ft ³ , l, kg
------------------	--

Reference conditions

Selectable conditions	20 °C 1000 mbar (ISO1217), 0 °C 1013 mbar (DIN1343) freely adjustable
-----------------------	---

Signal / Interface & Supply

Analog output

Signal	4 ... 20 mA (4-wire), isolated
Scaling	0 ... max flow, freely adjustable
Load	Max. 400 Ohm
Update rate	Value updated ever 1 sec

Pulse output

Signal	Switch output, normally open, max. 30 VDC, 200 mA
Scaling	1 pulse per consumption unit (selectable)

Fieldbus

Protocol	Modbus/RTU, HART, M-Bus
----------	-------------------------

Supply

Voltage supply	16 ... 30 VDC
Current consumption	200 mA

General data

Configuration

PC Software	USB Service Kit + Software
-------------	----------------------------

Display

Integrated	LCD
------------	-----

Material

Process connection	Stainless steel 1.4404 (SUS 316L)
Housing	Al alloy
Sensor	Stainless steel 1.4404 (SUS 316L)
Metal parts	Stainless steel 1.4404 (SUS 316L)

Miscellaneous

Electrical connection	Screw terminals
Protection class	IP67
Approvals	CE, RoHS, FCC, Ex-Options
Process connection	S450: G1/2" (ISO 228/1) S452: Measuring section with R-thread or Flange
Weight	S450: 1.75 kg S452: 1.25 kg (without measuring section)

Operating conditions

Medium	Air, N ₂ , O ₂ , CO ₂ and other non corrosive gases
Medium temperature	S450: -40 ... +150 °C S452: -40 ... +100 °C
Medium humidity	< 90 %, no condensation
Operating pressure	S450: 0 ... 1.6 MPa (applicable for option A1280) 0 ... 5.0 MPa (applicable for option A1279)* S452: 0 ... 4.0 MPa *For pressure above 1.5 MPa use the installation device A530 1106 or A530 1113.
Ambient temperature	-40 ... +65 °C
Storage temperature	-30 ... +70 °C
Transport temperature	-30 ... 70 °C
Pipe sizes	S450: ½" ... 12" (bigger pipes on request) S452: ½" ... 3"

Ordering

Please use the following tables to assist in placing your order with our sales staff.

S450 Thermal Mass Flow Meter (Insertion type)

Order No.	Description
S695 0450	S450, Thermal Mass Flow Meter insertion type
Shaft length	
A1200	220 mm
A1201	160 mm
A1202	300 mm
Process connection	
A1006	PT 1/2" Adapter
A1005	NPT 1/2" Adapter
Gas type	
A1007	Air
A1008	CO ₂
A1009	O ₂ (Oil- & grease-free cleaned)
A1010	N ₂
A1011	N ₂ O
A1012	Argon
A1013	Natural Gas
A1014	H ₂ (real gas calibration)
A1015	Other gas (please specify)
A1016	He (real gas calibration)
A1017	C ₃ H ₈
A1041	O ₂ , Ar, CO ₂ (real gas calibration)
Range	
A1275	Standard
A1271	Max range
A1272	Bi-directional standard range
A1273	Bi-directional max. range
A1274	High speed
A1276	Low range version (1/3 of standard range)
Hazardous area approval	
A1279	None
A1280	IECEX / GB3836 Ex
Output	
A1284	2 x 4 ... 20 mA + pulse
A1285	1 x 4 ... 20 mA + HART + pulse
A1286	1 x 4 ... 20 mA + Modbus + pulse
Display	
A1294	Without display
A1295	With display

Attention:

* Measuring section connection and size must be combined to get the order number. Example: A1306 = R-thread DN50

S452 Thermal Mass Flow Meter (In-line type)

Order No.	Description
S695 0452	S452, Thermal Mass Flow Meter, inline type
Process connection *	
A130X	R-thread (ISO 7-1)
A132X	Flange EN 1092-1, PN40
A134X	Flange ANSI 16.5
Measuring section size *	
1	DN15 (1/2")
2	DN20 (3/4")
3	DN25 (1")
4	DN32 (1.25")
5	DN40 (1.5")
6	DN50 (2")
7	DN65 (2.5")
8	DN80 (3")
Gas type	
A1007	Air
A1008	CO ₂
A1009	O ₂ (Oil- & grease-free cleaned)
A1010	N ₂
A1011	N ₂ O
A1012	Argon
A1013	Natural Gas
A1014	H ₂ (real gas calibration)
A1015	Other gas (please specify)
A1016	He (real gas calibration)
A1017	C ₃ H ₈
A1041	O ₂ , Ar, CO ₂ (real gas calibration)
Range	
A1275	Standard
A1271	Max range
A1274	High speed (DN15 ... DN50)
A1276	Low range version (1/3 of standard range)
Hazardous area approval	
A1279	None
A1280	IECEX / GB3836 Ex
Output	
A1284	2 x 4 ... 20 mA + pulse
A1285	1 x 4 ... 20 mA + HART + pulse
A1286	1 x 4 ... 20 mA + Modbus + pulse
Display	
A1294	Without display
A1295	With display

Accessories

Order No.	Description
R200 0005	Oil- & grease-free cleaned option for flow sensors (for Oxygen it is already included in A 1009)
A530 1106	High pressure installation device S450, 220 mm (to be used if pressure above 1.5 MPa)
A530 1113	High pressure installation device S450, 400 mm (to be used if pressure above 1.5 MPa)

S430

Pitot Tube Flow Meter for Wet Compressed Air

Insertion

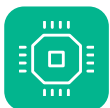

PROCESS MONITORING

High accuracy and reliable measurements



WET AIR MEASUREMENT

Directly at the compressor outlet



COMPRESSOR EFFICIENCY

Constant monitoring of the compressor performance



MOBILE APP

For remote configuration and monitoring



EASY INSTALLATION

Under pressure through a ball valve



NO MECHANICAL WEAR PARTS

Stable results in high temperature applications



Benefits

- ✓ Accurate flow and consumption measurement in wet air or high mass flow and velocity applications based on the pitot tube principle
- ✓ Consistent and temperature stable compressed air flow monitoring at the outlet of the compressor
- ✓ Various output signals with connection to SUTO displays and/or third-party displays and PLCs
- ✓ Easy installation under pressure through ball valve
- ✓ High temperature applications up to 230 °C

1 Optional Color Display

On-site display for live value readings, total consumption counter and convenient sensor settings. Totalizer with 10 digits (1 999 999 999).

2 Various Outputs

The S430 pitot tube flow meter is perfectly suited to be integrated into process controls or high-level monitoring systems. Various output options are offered for a seamless integration:

- Isolated 4 ... 20 mA output for actual flow readings
- Isolated Pulse output for totalizer
- Modbus/RTU to read all values digitally
- Modbus/TCP
- M-BUs

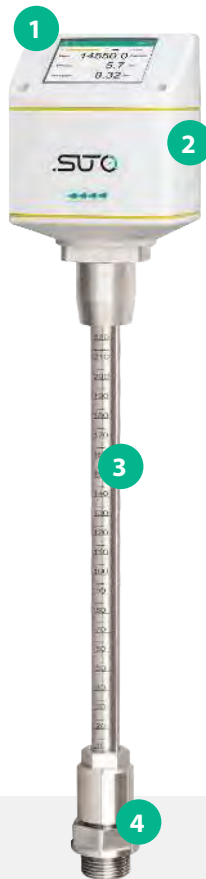

3 Robust Materials

- IP65 casing provides robust protection in rough industrial environment
- All parts which come into contact with the measurement medium are made of stainless steel 316L. This makes the sensors robust and guarantees a reliable measurement.

4 Flexible and Easy Installation

- Tube diameters of 1.25" to 10" through center installation, bigger diameters through non-center installation
- Thanks to the insertion through a 3/4" ball valve, the S430 can be installed and under pressure and is perfectly suited for installations where shutdowns are not acceptable.

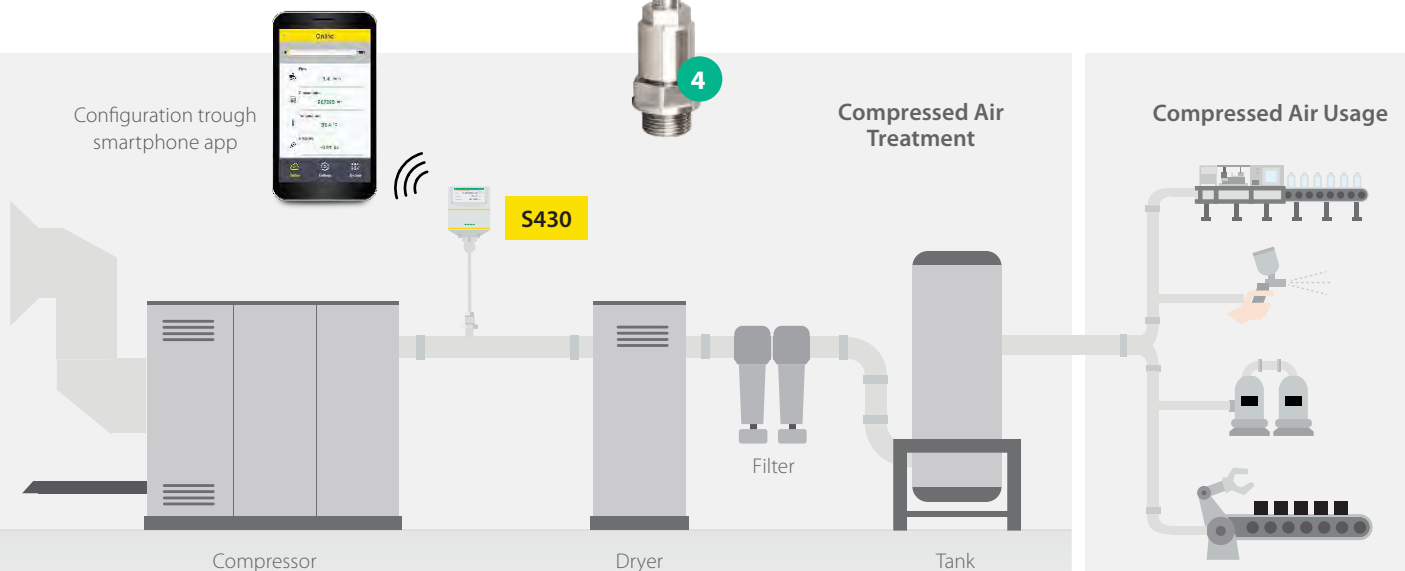

S430 Installation and Sensor Removal

Installation through a ball valve

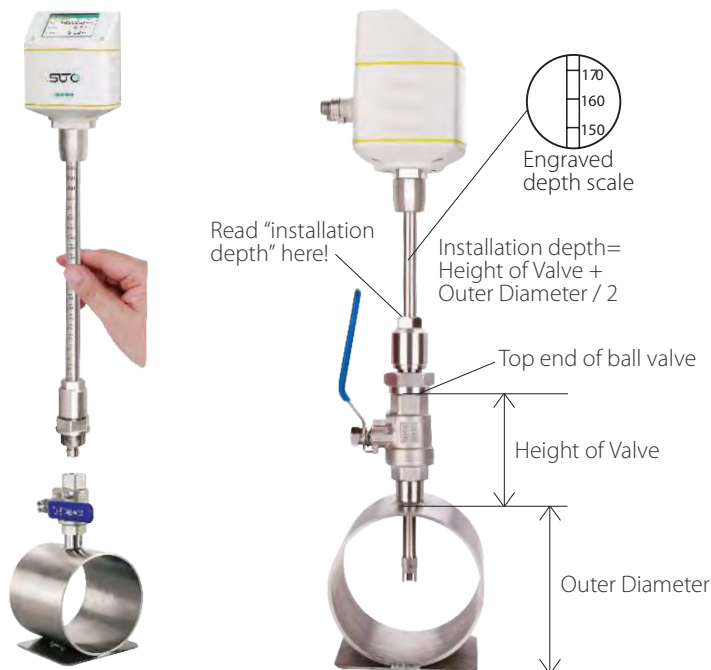

S430 Dimensions

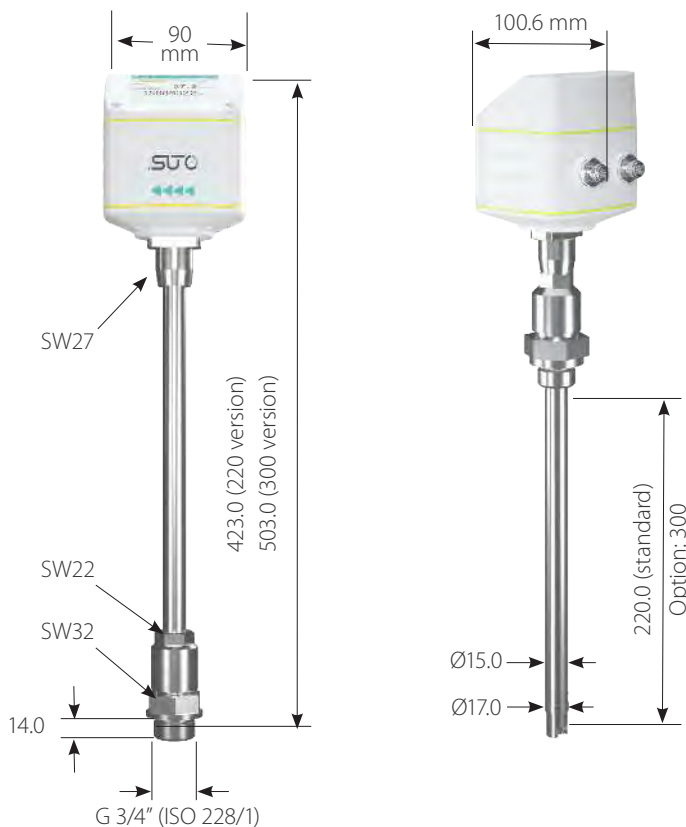

Mobile App

Mobile Phone app for configuration and online readings. The app enable users to completely get rid of the inconvenience caused by cables, bulky PCs and hard-to-reach places.



Based on the pitot tube principle

The S430 is based on the pitot tube principle to measure flow. Properly installed (refer to instruction manual for details) the sensor can measure in wet and dirty gases as occurring, for example, at the discharge of a compressor.

Optional Color Display



Colour graphic display for online values and sensor settings

Connect several Flow Meters to Modbus Master

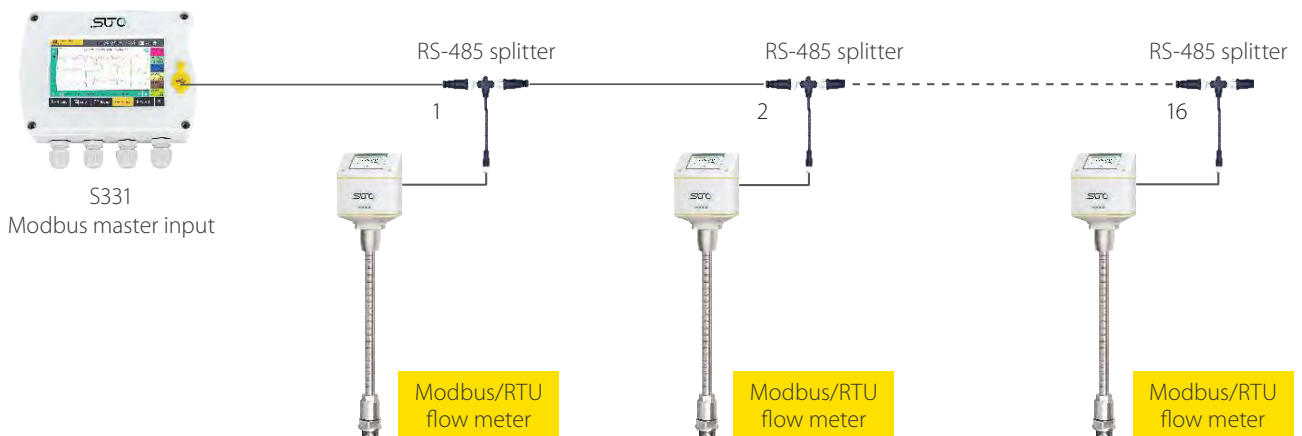

Flow meters can be easily integrated into a Modbus/RTU network (daisy chain)

Volumetric Flow Ranges

Tube		Volumetric Flow					
		m ³ /h		m ³ /min		cfm	
Inch	mm	Min	Max	Min	Max	Min	Max
1¼"	36	49	507	0.8	8.5	29	298
1½"	41.9	73	757	1.2	12.6	43	446
2"	53.1	124	1298	2.1	21.6	73	764
2½"	68.9	221	2311	3.7	38.5	130	1360
3"	80.9	313	3270	5.2	54.5	184	1925
4"	100	488	5094	8.1	84.9	287	2998
5"	125	767	8006	12.8	133	451	4712
6"	150	1107	11547	18.5	192	652	6796
8"	200	1983	20689	33.1	345	1167	12177
10"	250	3099	32338	51.7	539	1824	19034
12"	300	4462	46567	74.4	776	2626	27408

Stated measuring ranges under following conditions:

- Standard flow in air
- Reference pressure: 1000 hPa
- Reference Temperature: +20 °C

Flow range is calculated for Air at 6 bar(g), 50 °C and 90 % humidity.

Mobile Power

S430 powered by power bank with connection cable A553 0154.

Note: power bank must be sourced locally due to shipping restrictions [USB-C, 20 V, min. 100 mA]

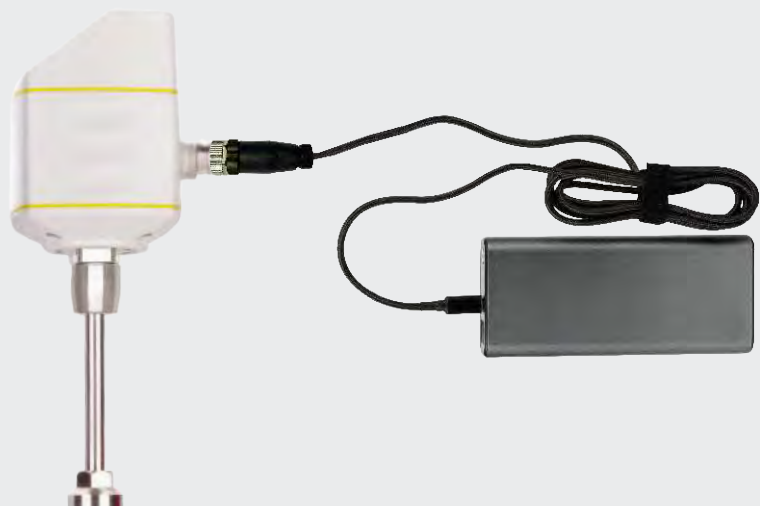

Technical Data

Measurement

Flow

Accuracy	1.5 % o.r. ± 0.3 % FS Volumetric Flow: m ³ /h, m ³ /min, L/min, l/s, cfm Mass Flow: kg/h, kg/min, kg/s, t/h, lb/h
----------	---

Selectable units	Actual Velocity: m/s, ft/min
------------------	------------------------------

Measuring range	see table on the previous page
-----------------	--------------------------------

Repeatability	0.5 % o.r.
---------------	------------

Sensor	Differential pressure sensor
--------	------------------------------

Sampling rate	3/sec
---------------	-------

Turndown ratio	10:1
----------------	------

Response time (t ₉₀)	2 sec
----------------------------------	-------

Consumption

Selectable units	m ³ , ft ³ , t, lb, l, kg
------------------	---

Reference conditions

Selectable conditions	20 °C 1000 mbar (ISO1217) 0 °C 1013 mbar (DIN1343) freely adjustable
-----------------------	--

Signal / Interface & Supply

Analog output

Signal	4 ... 20 mA, isolated
--------	-----------------------

Scaling	0 ... max flow
---------	----------------

Load	250R
------	------

Update rate	1/sec
-------------	-------

Pulse output

Signal	Max 30 V, 200 mA
--------	------------------

Scaling	1 pulse per consumption unit
---------	------------------------------

Fieldbus

Protocol	Modbus/RTU, Modbus/TCP
----------	------------------------

Update rate

Supply

Voltage supply	24 VDC 48 VDC (PoE)
----------------	------------------------

Current consumption	150 mA 100 mA (PoE)
---------------------	------------------------

General data

Configuration

Wireless	S4C-FS App for mobile phones
----------	------------------------------

Others	Display with 3 touch buttons (Option)
--------	---------------------------------------

Display

Integrated	2.4" color graphic display with 3 touch buttons (option)
------------	---

Material

Process connection	Stainless steel 1.4404 (SUS 316L)
--------------------	-----------------------------------

Housing	PC + ABS
---------	----------

Sensor	Stainless steel 1.4404 (SUS 316L)
--------	-----------------------------------

Metal parts	Stainless steel 1.4404 (SUS 316L)
-------------	-----------------------------------

Miscellaneous

Electrical connection	2 x M12 (5 pole) 1 x M12 (8-pole x-coded) for TCP
-----------------------	--

Protection class	IP65
------------------	------

Approvals	CE, RoHS, FCC
-----------	---------------

Process connection	G 3/4" (ISO 228/1)
--------------------	--------------------

Weight	1.12 kg
--------	---------

Operating conditions

Medium	Wet/dry air, other gases
--------	--------------------------

Medium quality	non corrosive
----------------	---------------

Medium temperature	-40 ... +230 °C
--------------------	-----------------

Medium humidity	no requirements
-----------------	-----------------

Operating pressure	0 ... 1.6 MPa -30 ... +70 °C housing 0 ... +50 °C display (Optional)
--------------------	--

Ambient temperature	-10 ... +40 °C PoE (Optional)
---------------------	-------------------------------

Ambient humidity	< 95 % rH
------------------	-----------

Storage temperature	-30 ... 70 °C
---------------------	---------------

Transport temperature	-30 ... 70 °C
-----------------------	---------------

Pipe sizes	\geq DN32
------------	-------------

Ordering

Please use the following tables to assist in placing your order with our sales staff.

S430 Pitot Tube Flow Sensor (Insertion Type)

Order No. Description

S695 4300 S430, Pitot Tube Flow Meter, insertion type, 220 mm shaft

S695 4302 S430, Pitot Tube Flow Meter, insertion type, 300 mm shaft

Flow Medium

A1007 Option, flow medium Air

A1008 Option, flow medium CO₂

A1009 Option, flow medium O₂ (cleaning for oil and grease-free)

A1010 Option, flow medium N₂

A1011 Option, flow medium N₂O

A1012 Option, flow medium Argon

A1013 Option, flow medium Natural Gas

A1014 Option, flow medium H₂ (For real gas calibration. Please consult manufacturer for this option in advance)

A1015 Other gas (specify gas or gas mix)

A1016 Option, flow medium He (real gas calibration)

Range / Calibration

A1066 Bi-directional standard range

A1067 High speed: Max flow increased by 30 %

Output

A1410 Isolated 4 ... 20 mA + Pulse output

A1411 Modbus/RTU output

A1424 Modbus/TCP output with PoE support

A1063 M-Bus

Display

A1425 No display

A1420 Color graphics display, 2.4" with keypad

Accessories

A695 0010 PT 3/4" thread adapter (former A1068)

A695 0011 NPT 3/4" thread adapter (former A1069)

A553 0104 Sensor cable, 5 m with M12 connector, open wires, AWG 24 (0.2 mm²)

A553 0105 Sensor cable, 10 m with M12 connector, open wires, AWG 24 (0.2 mm²)

A553 0154 Cable to connect power bank, 1.8 m, USB-C connector for power bank, M12 connector

Example: S430, 300 mm shaft, Air, bi-directional calibration, Modbus/RTU, display

Order Code: S695 4302.A1007.A1066.A1411.A1420

S409

Thermal Mass Flow Direction Switch

Insertion



**NO MECHANICAL
WEAR PARTS**
Robust Design



**FLOW
DIRECTION**
Reliable indication



**EASY
INSTALLATION**
Under pressure



RELAY OUTPUT
1 relay for each
direction



Benefits

- ✔ Accurate and fast detection of the flow direction
- ✔ Detects smallest changes < 0.1 m/s referred to 20 °C and 1000 hpa
- ✔ No mechanical wear parts for long term stable measurements
- ✔ Easy installation under pressure without stopping the operation

1 Robust Materials

IP65 casing provides robust protection in rough industrial environments to ensure reliable measurement results.

2 Flexible Installation

Through a 1/2"G-type ball valve the switch can be inserted into the pipe under pressure without shutting down the system.

3 Thermal Mass Flow Sensor

The thermal mass flow sensor element comes with main advantages:

- Very robust and completely of stainless steel
- Fast response times and wide measuring range at high accuracy
- Minimal pressure loss



4 Connection

Pin assignment connector

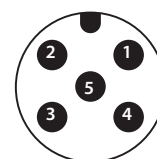

Pin arrangement of flow switch

	Pin1	Pin2	Pin3	Pin4	Pin5
A	SDI	-VB	+VB	DIR1	DIR1
B	SDI	-VB	+VB	DIR2	DIR2

Relay output at switch

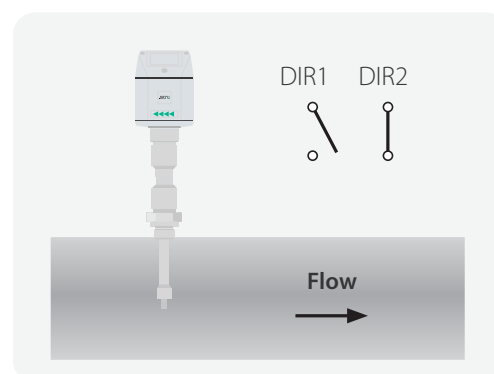
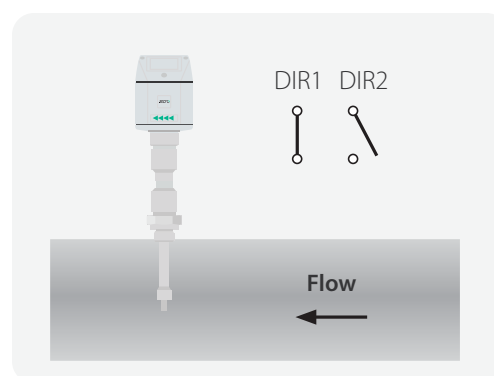

Operation Principle

The thermal mass flow direction switch S409 allows the detection of direction of the flow. It can be used in compressed air and non-corrosive gases.

The flow and direction information is output through 2 normally open relay switches. The signals can be transferred to the SUTO flow sensor to activate and deactivate the flow measurement depending on the flow direction, as well as triggering which consumption counter is used.

Connection of S330 to S450 via flow switch

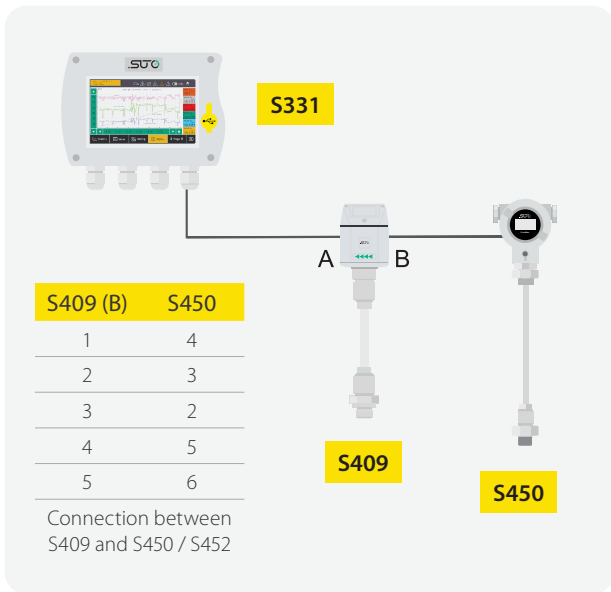

Connection of S330 to S401 with flow switch

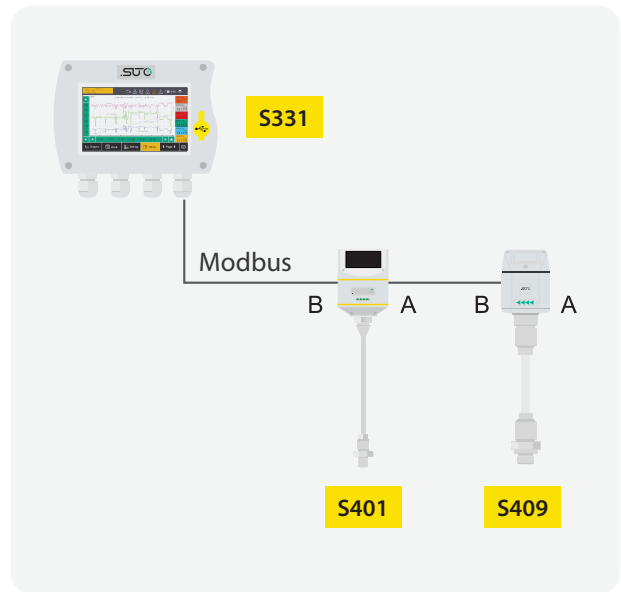

Attention: Flow sensors S450 / S401 need to have the bi-directional calibration option to operate in both directions

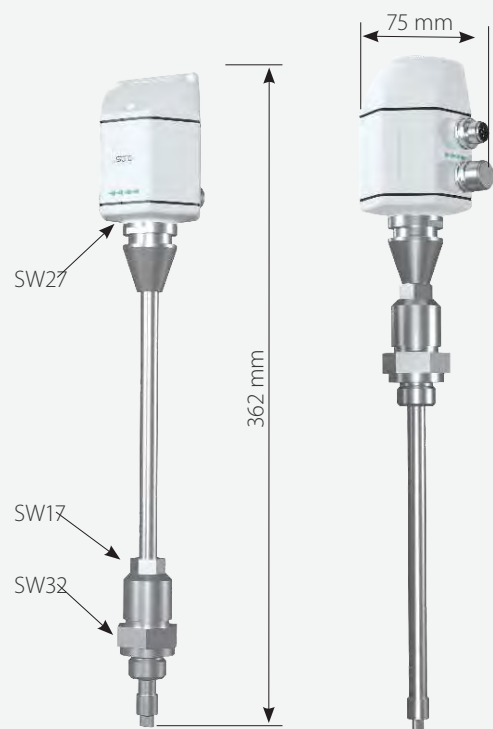

Technical Data

Measurement

Flow Direction Detection

Accuracy	0.05 m/s
Measuring range	0.02 ... 25 m/s @ 7barg, 20 °C
Sensor	2 x Pt 1000

Signal / Interface & Supply

Switch output

Relay	2 x isolated direction switches
Rating	60 VDC, 1 A

Supply

Voltage supply	24 VDC
Current consumption	160 mA

General data

Material

Process connection	G½" (ISO 228-1)
Housing	PC + ABS
Sensor	Ceramic sensor, glass coated
Metal parts	Stainless steel 1.4404 (SUS 316L)

Miscellaneous

Electrical connection	2 x M12 5-pole
Protection class	IP65
Approvals	CE
Process connection	½" G (ISO 228-1)
Weight	500 g

Operating conditions

Medium	air, gases
Medium quality	ISO 8573: 4.4.3 or better
Medium temperature	-20 ... +80 °C
Medium humidity	< 100 % (no condensation)
Operating pressure	0 ... 1.6 MPa
Ambient temperature	-20 ... +70 °C
Ambient humidity	< 99 % (no condensation)
Storage temperature	-40 ... +70 °C
Transport temperature	-40 ... +70 °C
Pipe sizes	½ to 12 (bigger diameters on request)

Ordering

Please use the following table to assist in placing your order with our sales staff.

S409 Thermal Mass Flow Direction Switch (Insertion)

Order No. Description

S695 0409	S409 Thermal Mass Flow Direction Switch, insertion type
A553 0104	Sensor cable 5 m, with M12 connector, open wires, AWG 24 (0.2 mm ²)
A553 0105	Sensor cable 10 m, with M12 connector, open wires, AWG 24 (0.2 mm ²)

S435

Vortex Flow Meter for Steam

Inline



INTERGRATED TEMPERATURE SENSOR

Automatic density
adjustment

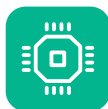

EASY PROCESS MONITORING

Effective and
inexpensive
measurements



ACCURATE RESULTS

Very fast
response time



TOTAL FLOW

High accuracy
and reliable
measurements

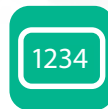

LOCAL DISPLAY

For easy
configuration and
live values

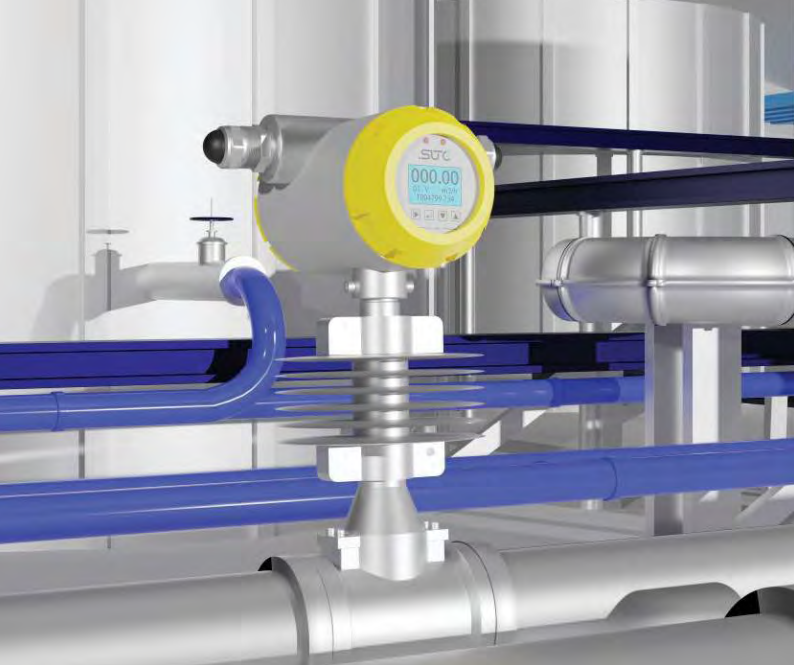

Benefits

- ✔ Accurate saturated steam measurement by instant flow and consumption monitoring
- ✔ Integrated temperature sensor and small pressure loss
- ✔ High protection level due to robust industrial design and no moving parts
- ✔ Analog and Modbus output for data logging and analysis
- ✔ Wafer type makes it easy for installation

Accurate Steam Monitoring

Vortex flow meters are the ideal choice for steam measurements due to their robust design, without any moving parts and high temperature/pressure resistance.

S435 provides mass flow and consumption measurements in saturated steam with automatic density compensation. This always guarantees accurate results. Parameter settings can be done through the user interface (keys and display) at the flow meter directly. Connection to an SCADA system is through the Modbus/RTU interface or the analog output available.

Please ensure that the steam parameters such as temperature, pressure and nominal flow are within the specification of S435.

Installation

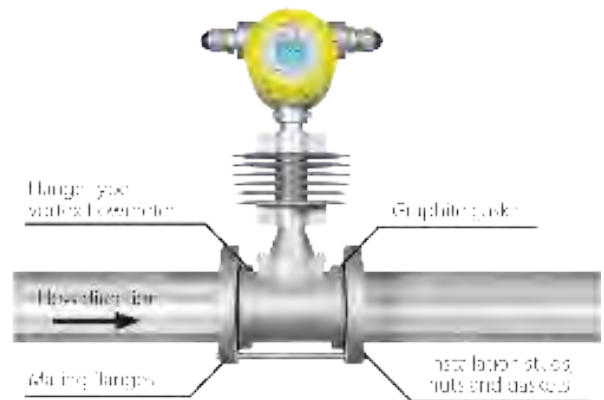

Use double bolts and nuts. We provide gaskets and bolts.

Dimensions

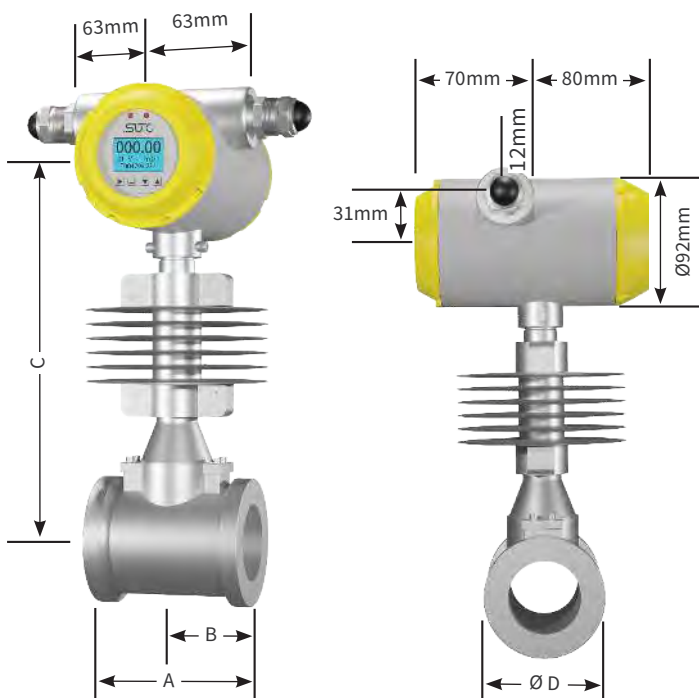

Vortex Flow Meter dimension rated pressure 1.6 MPa unit: mm

DN	A	B	C	D
40	100	50	256	75
50	110	55	256	87
65	110	55	262	109
80	110	55	267	120
100	120	60	271	149
125	133	73	291	175
150	160	90	304	203
200	185	115	331	259
250	210	140	357	312
300	240	165	383	363

Technical Data

Measurement

Flow

Accuracy	1.5 % of reading
Selectable units	m ³ /h, m ³ /min, kg/h, t/h
Measuring range	see table below
Repeatability	0.5 % o.RDG
Sensor	Vortex
Turndown ratio	10:1

Consumption

Selectable units	m ³ , kg, t
------------------	------------------------

Signal / Interface & Supply

Analog output

Signal	4 ... 20 mA (4-wire), isolated
Scaling	0 ... max flow, freely adjustable
Update rate	Value updated ever 1 sec

Frequency output

Measuring range	0~5000 Hz
-----------------	-----------

Fieldbus

Protocol	Modbus/RTU
Update rate	Value updated ever 1 sec

Supply

Voltage supply	24VDC
----------------	-------

General Data

Display

Integrated	LCD display
------------	-------------

Material

Process connection	Carbon steel /304/316/316L(Flange/Wafer)
Housing	SUS 304
Sensor	SUS 316
Metal parts	SUS 304

Miscellaneous

Electrical connection	1/2"-14NPT
Protection class	IP65
Process connection	wafer
Weight	depends on pipe size - please enquire if needed

Operating conditions

Medium	Saturated steam
Medium temperature	-40 ... +250 °C
Operating pressure	0 ... 1.6 MPa (applicable for option 2.5MPa or 4.0MPa)
Ambient temperature	-10 ... +60 °C
Ambient humidity	< 99 % rH
Storage temperature	-10 ... +60 °C
Transport temperature	-10 ... +60 °C
Pipe sizes	DN25 ... DN300

Measuring ranges

Saturated Steam Mass Flowrate (Unit: t/h)

DN (mm)	0.20 MPa		0.50 MPa		0.60 MPa		0.70 MPa		1.00 MPa		1.50MPa	
DN40	(28.8 ~ 329.8 kg/h)		(39.9 ~ 633.0 kg/h)		(42.9 ~ 732.5 kg/h)		0.05	0.83	0.05	1.13	0.06	1.61
DN50	0.04	0.52	0.06	0.99	0.07	1.14	0.07	1.29	0.08	1.76	0.1	2.52
DN65	0.08	0.87	0.11	1.67	0.11	1.93	0.12	2.18	0.14	2.97	0.17	4.26
DN80	0.12	1.32	0.16	2.53	0.17	2.93	0.18	3.3	0.21	4.5	0.25	6.45
DN100	0.18	2.06	0.25	3.96	0.27	4.58	0.28	5.16	0.33	7	0.4	10.08
DN125	0.28	3.22	0.39	6.18	0.42	7.15	0.44	8.06	0.52	11	0.62	15.76
DN150	0.4	4.64	0.56	8.9	0.6	10.3	0.64	11.61	0.75	15.83	0.9	22.69
DN200	0.72	8.25	1	15.83	1.07	18.31	1.14	20.64	1.33	28.14	1.59	40.34
DN250	1.12	12.88	1.56	24.73	1.68	28.61	1.78	32.25	2.1	44	2.49	63.03
DN300	1.62	18.55	2.24	35.61	2.41	41.2	2.56	46.45	3	63.3	3.58	90.76

Ordering

Please use the following table to assist in placing your order with our sales staff.

S435 Vortex Flow Meter for Steam (Inline)

Order No.	Description
S695 4359	S435 Vortex Flow Meter DN40, wafer type
S695 4350	S435 Vortex Flow Meter DN50, wafer type
S695 4351	S435 Vortex Flow Meter DN65, wafer type
S695 4352	S435 Vortex Flow Meter DN80, wafer type
S695 4353	S435 Vortex Flow Meter DN100, wafer type
S695 4354	S435 Vortex Flow Meter DN125, wafer type
S695 4355	S435 Vortex Flow Meter DN150, wafer type
S695 4356	S435 Vortex Flow Meter DN200, wafer type
S695 4357	S435 Vortex Flow Meter DN250, wafer type
S695 4358	S435 Vortex Flow Meter DN300, wafer type
A695 0001	Blind pipe for uninstillation - DN40&DN50
A695 0002	Blind pipe for uninstillation - DN65
A695 0003	Blind pipe for uninstillation - DN80
A695 0004	Blind pipe for uninstillation - DN100
A695 0005	Blind pipe for uninstillation - DN125
A695 0006	Blind pipe for uninstillation - DN150
A695 0007	Blind pipe for uninstillation - DN200

Notes:

All Flow meters: Wafer connection (Companion flange, bolt and gasket included), temperature compensation, local display, medium temperature <250 °C, 4-20 mA signal output, 1/2-14 NPT electric connection, IP65, accuracy +1.5 %, 24 VCD, Modbus/RTU, Pulse, for saturated steam only

S461

Ultrasonic Flow Meter for Liquid

Clamp-on

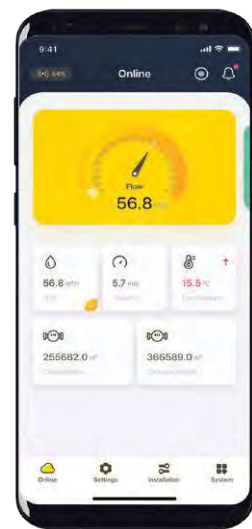

NON-INVASIVE MEASUREMENT
Through clamp-on sensors



SMARTPHONE APP
Easy configuration



ENERGY METER
Monitors of heat exchangers



COMPACT DESIGN
Can be installed anywhere



LOCAL DISPLAY
For instant values



DATA LOGGER
8 million samples



EASY INSTALLATION
Various installation options



Benefits

- ✔ Measures the actual flow and total consumption of various liquids
- ✔ The configuration through the dedicated smartphone app is easy and most user friendly
- ✔ Connectable to any monitoring system, through various signal interfaces: Modbus/RTU (standard), 4 ... 20 mA / Pulse / Alarm-Relay (option), Modbus/TCP (option)
- ✔ Flow and consumption can be measured in both directions, forward and reverse (Bi-directional measurement)
- ✔ Robust industrial design with versatile installation options for the display unit: Wall installation, DIN rail and pipe installation
- ✔ Measurement log files can be downloaded through the free S4A software. Soon a wireless readout will be available through mobile App

Accurate Liquid Measurement

The SUTO ultrasonic clamp-on flow meter S461 has all it takes to measure reliable, easy and accurate flow and consumption of liquids. Based on the transit time technology this flow meter comes with unique features and outstanding performance.

The transducers are simply clamped onto the outside of the pipe and never come in contact with the fluid. The main unit is either installed onto the pipe as well, at the wall or onto a DIN rail.

The configuration and setup is made through the wireless smartphone app S4C-US which can be downloaded for free from the SUTO website, Google Play Store and the Apple App Store. The app allows the user to set up the device as well as reading live values, logger configuration and logger data read out.

By adding 2 clamp-on temperature sensors the Energy Meter Version monitors the efficiency of heat exchangers.

The S461 comes also as portable version in a transport case.

Transit Time Principle

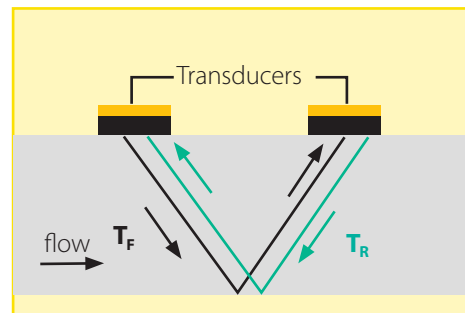

T_F : time in flow direction
 T_R : time in reverse flow direction

A number of pulses are transmitted from one transducer to the other and vice-versa. Sound waves travel faster with the direction of flow and slower against the direction of flow.

Mobile App

Instant view of daily, weekly and monthly consumption through mobile app.



S461 and transducers mounted on pipe



Heat Recovery Principle

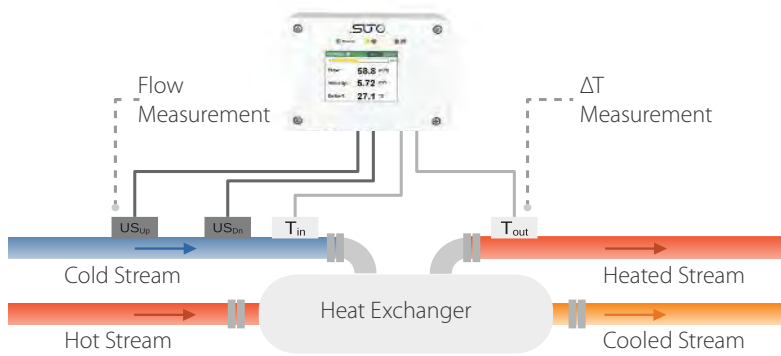

Principle heat recovery measurement with S461 Energy Meter

Heat exchangers transfer heat (energy) from a higher temperature medium (hot stream) to a colder one (heated stream). S461 measures the flow rate and the temperature difference between cold stream and heated stream. Based on these measurements the recovered energy will be calculated.

Convenient Storage

Transport casing holding up to 2 transducer pairs, T-Sensors, belt and metal stretchers, power bank, cables, charger and documentation



Accessories



Temperature sensor with metal stretcher



UTH-S transducer for higher temperature applications



Belt stretcher for temporary installation



Transducer mounting fixture simplify the flow transducer installation

Applications

- Cooling / Heating / Process Water
- Purified Water Measurement
- Fuel, Oils, Petroleum Products
- Water Treatment
- Food / Beverage
- HVAC / Energy System Audits
- Sanitary flow metering
- Hydraulic System Test
- Pharmaceutical Industry

Mobile Power

S461 powered by power bank with connection cable A553 0154

Note: power bank must be sourced locally due to shipping restrictions [USB-C, 20 V, min. 100 mA]



Technical Data

Measurement

Flow

Accuracy	1.0 % o. RDG \pm 0.01 m/s	
Selectable units	Metric:	m/s, m ³ /h, m ³ /min, l/min, m ³
	Imperial:	ft/min, cfm, cfs, USG/min, IG/min, bbl/min
Measuring range	0 ... 12 m/s	
Repeatability	0.5 % o.RDG	
Transducer	Ultrasonic transducer	
Sampling rate	5 samples / sec	
Response time (t90)	0.1 sec	

Consumption

Selectable units	Metric:	m ³ , l
	Imperial:	cf, IG, UG, bbl

Temperature

Accuracy	0.5 °C	
Selectable units	Metric: °C. Imperial: °F	
Measuring range	-40 ... +130 °C	
Sensor	Pt1000	

Energy Flow

Selectable units	Metric:	GJ/h, kJ/h, kcal/h
	Imperial:	MBtu/h, Btu/h

Energy

Selectable units	Metric:	GJ, kJ, kcal, kWh, MWh
	Imperial:	Mbtu, Btu

Signal / Interface & Supply

Analog output (Option)

Signal	4 ... 20 mA (4-wire), isolated
Scaling	0 ... max flow, freely adjustable
Load	max. 250 Ohm
Update rate	100 ms

Pulse output (Option)

Signal	Switch output, normally open, nominal value: 24 VDC/0.5 A
Scaling	1 pulse per consumption unit (selectable)

Fieldbus

Protocol	Modbus/RTU (Standard) Modbus/TCP and PoE (Option)
----------	--

Supply

Voltage supply	20 ... 28 VDC
Current consumption	150 mA @ 24 VDC

General data

Configuration

Wireless	S4C-US App for mobile phones
----------	------------------------------

Display

Size/Resolution	2.4" color (640 x 480) graphic display, 1 touch button
-----------------	--

Data Logger

Storage	8 Mio. values
---------	---------------

Material

Main Casing	PC + ABS
Transducer	UT-S: Industrial synthetic plastics UTH-S: Aluminum

Miscellaneous

Electrical connection	2 x M12 D code (4 pole): transducer 2 x M12 (5 pole): Signals/Supply. (8-pole x-coded) for TCP 2 x M8 (4 pole): Pt1000 (Energy Meter Version)
-----------------------	--

Protection class	Main casing: IP65. Transducer: IP68
------------------	-------------------------------------

Approvals	CE, RoHS, FCC
-----------	---------------

Dimensions	Main unit: 124 x 102 x 70 mm UT-S Transducer: 64 x 30 x 27 mm UTH-S Transducer: 68 x 34 x 34 mm
------------	---

Weight	1.2 kg
--------	--------

Operating conditions

Fluids	All acoustically conductive liquids with less than 10 % gaseous
--------	---

Medium temperature	-40 ... +130 °C
--------------------	-----------------

Ambient temperature	Main unit: 0 ... +50 °C UT-S Transducer: 0 ... +80 °C UTH-S Transducer: -40 ... +130 °C
---------------------	---

Ambient humidity	< 99 % rH
------------------	-----------

Storage temperature	-30 ... 70 °C
---------------------	---------------

Transport temperature	-30 ... 70 °C
-----------------------	---------------

Pipe sizes	DN40 ... DN1200
------------	-----------------

Flow Ranges

DN	DO	Max flow		
		l/min	m ³ /h	cfm
40	48	905	54	32
50	60	1,414	85	50
65	76	2,389	143	84
80	88	3,619	217	128
100	114	5,655	339	200
125	139	8,835	530	312
150	165	12,723	763	449
200	219	22,618	1,357	799
250	273	35,341	2,121	1,248
300	323	50,891	3,054	1,797
500	508	141,365	8,482	4,992
1000	1016	565,458	33,929	19,970
1200	1219	814,260	48,858	28,756

Remarks: DN: nominal inner diameter

DO: outer diameter (depends on standard and material)

Ordering

Please use the following tables to assist in placing your order with our sales staff.

S461 Ultrasonic Flow Meter for Liquids (Clamp-On)

Order No. Description

D695 4610	S461 Ultrasonic Flow Meter for Liquids main unit, USB, data logger and display
D695 4611	S461 Ultrasonic Flow & Energy Meter for Liquids main unit, USB, data logger, display and 2 additional M8 temperature inputs

Main Unit Mounting Plate

A4603	Pipe/Wall mounting plate (for pipe mounting please order metal stretcher separately)
A4604	35 mm DIN rail mounting plate
A4602	No mounting

Output Options

A4605	Modbus/RTU
A4606	Modbus/RTU + 4 ... 20 mA, Pulse / Alarm
A4607	Modbus/RTU + Modbus/TCP

S461 Ultrasonic transducers for flow meter

S695 4610	UT-S, Ultrasonic transducer pair, DN40 ... DN1200, 5 m cable, M12 connector, 0 ... +80 °C, IP68 (includes coupling agent)
S695 4611	UTH-S, Ultrasonic transducer pair, DN40 ... DN1200, 5 m cable, M12 connector, -40 ... +130 °C, IP68 (includes coupling agent)

S461 Temperature Sensors for Energy Meter

S693 4610	Temperature sensor pair, 5 m cable, M8 connector -40 ... +130 °C, IP42, for S461 Energy Meter only (D695 4611)
-----------	--

Sensor Installation

	Metal stretcher for transducer and main unit installation on pipes
A695 4601	DN40 ... DN65 (2 pieces)
A695 4602	DN80 ... DN100 (2 pieces)
A695 4603	DN125 ... DN150 (2 pieces)
A695 4604	DN200 ... DN300 (2 pieces)
A695 4605	DN350 ... DN500 (2 pieces)
A695 4608	Belt stretcher for temporary sensor installations (portable unit), DN40 ... DN500 (2 pieces)

Example: S461 Flow Meter, No mounting, Modbus/RTU, UT-S transducer, DN80...DN100 stretcher

Order Code: D695 4610.A4602.A4605
S695 4610
A695 4602

Useful Accessories

Order No. Description

A553 0104	Sensor cable, 5 m, M12 connector, open wires, AWG 24 (0.2 mm ²)
A553 0105	Sensor cable, 10 m, M12 connector, open wires, AWG 24 (0.2 mm ²)
A554 0107	Mains unit 100 ... 240 VAC/24 VDC, 0.5 A for SUTO sensors, 1.5 m cable, M12 connector
A554 4625	Transport casing S461 dimensions: 560 x 450 x 160 mm (portable unit)
A553 0159	S461 flow transducer extension cable pair, 5 m, M12, 4-pole male/female
A553 0163	S461 temperature sensor extension cable pair, 5 m, M8, 4-pole male/female
A695 4610	Coupling agent for sensor installation, 65 g
A695 4617	Transducer mounting fixture for (UT-S) ultrasonic flow transducer pair
A695 4618	Transducer mounting fixture for (UTH-S) high-temperature ultrasonic flow transducer pair
A553 0154	Cable to connect power bank, 1.8 m, USB-C connector for power bank, M12 connector

Calibration & Services

Order No. Description

R200 4610	Calibration S461 together with transducer pair
R200 4613	Calibration temperature sensor S461

S462

Compact Ultrasonic Flow Meter for Liquids

Clamp-on



CLAMP ON
No contact
to medium



**TRANSIT TIME
CORRELATION
TECHNIQUE**



PORTABLE
Connectable
to S551



**LOCAL
DISPLAY**
For easy
configuration
and live values

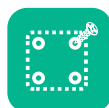

STATIONARY
Connectable to
S330 / S331 series



**COMPACT
DESIGN**
Can be installed
anywhere



Benefits

- ✔ Clamp on type, very easy installation
- ✔ No moving parts
- ✔ Can be installed on stainless steel pipe, carbon steel pipe, copper pipe or plastic pipe such as (PVC, PVDF, PPR, PPH, HDPE, etc.)
- ✔ Clean fluid measurements: water, sea water, others on request
- ✔ Available pipe sizes: DN20, DN25, DN32, DN40

Time-efficient Liquid Measurement

The S462 ultrasonic clamp on flow meter for liquids uses the proven transit-time correlation technique. The unit is simply clamped onto the pipe and will never come in contact with the fluid.

Available in pipe sizes from DN20 ... DN40 the S462 impresses with ease of installation and accurate flow readings. It comes with Modbus/RTU interface and 4 ... 20 mA output, which makes it easy connectable to any facility monitoring system.

Of course S462 clamp on ultrasonic flow meter also works with the SUTO displays and data loggers S330/331 and S551.

Dimensions (Main Unit)



Dimensions (Mounting Bracket)

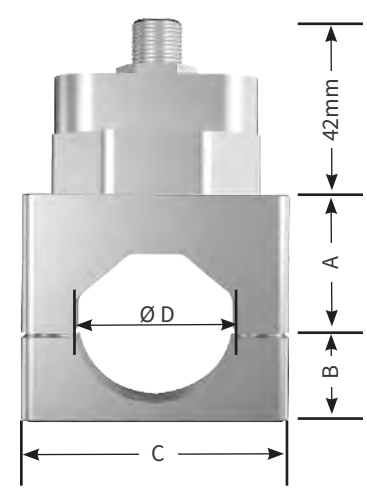

Model size	A (mm)	B (mm)	C (mm)	D (mm)	
				min	max
DN20	26.5	15	58	25	28
DN25	30	18	58	32	35
DN32	33	22.5	68	38	45
DN40	38	27	78	48	54

Easy Installation



Placing the couplant pads before installation to the downside part of the main unit

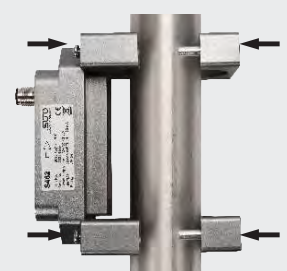

Easy clamp-on installation through mounting brackets



Vertical installation on a water pipe

Technical Data

Measurement

Flow

Accuracy	1.5 % o.RDG + 0.2 % FS (0.5 ... 5.0 m/s)
Selectable units	m ³ /h, l/min, GAL
Measuring range	see table below
Repeatability	0.80 % o.RDG
Sensor	Piezo ultrasonic transducer
Sampling rate	3 samples / sec
Turndown ratio	10:1
Response time (t90)	<2 sec

Consumption

Selectable units	m ³ , liter, GAL
------------------	-----------------------------

Reference conditions

Selectable conditions	20 °C 1000 mbar (ISO1217), 0 °C 1013 mbar (DIN1343) freely adjustable
-----------------------	---

Signal / Interface & Supply

Analog output

Signal	4 ... 20 mA
Scaling	0 ... max flow / adjustable
Load	<600R
Update rate	3/sec

Fieldbus

Protocol	Modbus/RTU
----------	------------

Supply

Voltage supply	20 ... 28 VDC
Current consumption	100 mA @ 24 VDC

General data

Configuration

Settings	via integrated keyboard
----------	-------------------------

Display

Integrated	OLED, 128 x 64 pixel (31 x 16 mm)
------------	-----------------------------------

Data Logger

Totalizer	Daily, monthly, yearly consumption
-----------	------------------------------------

Material

Housing	Aluminum alloy
Sensor	PEI
Display cover	PMMA
Key pad	F150

Miscellaneous

Dimensions	see dimension drawing
Electrical connection	1 x M12 (5 pole)
Protection class	IP65
Approvals	CE, RoHS, FCC
Weight	0.47 ... 0.60 kg (depends on model)

Operating conditions

Medium	Water, sea water, others on request
Medium quality	No solid particles, no air bubbles
Pipe material	Carbon steel, stainless steel, copper, PVC, PP, PU
Medium temperature	0 ... 50 °C
Ambient temperature	0 ... 50 °C
Ambient humidity	< 95 % rH
Storage temperature	-30 ... +70 °C
Transport temperature	-30 ... +70 °C
Pipe sizes	DN20, DN25, DN32, DN40

Model Depending Technical Data

	Model	DN20	DN25	DN32	DN40
Pipe size	Pipe OD (mm)	25 ... 28	32 ... 35	38 ... 45	48 ... 54
	Pipe ID (mm)	20	25	32	40
	NPS	3/4"	1"	1¼"	1½"
Flow Range	Min flow (l/min)	0.94	1.47	2.41	3.77
	Max flow (l/min)	94.2	147.2	241.2	377.0

Ordering

Please use the following tables to assist in placing your order with our sales staff.

S462 Compact Ultrasonic Flow Meter for Liquids (Clamp-On)

Order No.	Description
-----------	-------------

S695 4621	S462 Clamp On Ultrasonic Flow Meter, DN20 , including 2m cable and 4 couplant pads
S695 4622	S462 Clamp On Ultrasonic Flow Meter, DN25 , including 2m cable and 4 couplant pads
S695 4623	S462 Clamp On Ultrasonic Flow Meter, DN32 , including 2m cable and 4 couplant pads
S695 4624	S462 Clamp On Ultrasonic Flow Meter, DN40 , including 2m cable and 4 couplant pads

Accessories

Order No.	Description
-----------	-------------

A695 4620	Couplant pad, 4 pieces, 0 ... +80 °C
A554 0129	Transport casing S462 , can hold 4 units, battery pack, 2 m cable, 5 m cable, cal cert, IM, dimensions: 465 x 365 x 185 mm
A554 0107	Plug-in power supply, 100 ... 240 VAC / 24 VDC, 0.5 A , 2 m cable M12 connector. Recommended for portable unit
A553 0156	Cable to connect external power bank, 1.8 m, USB-C connector for power bank, M12 connector 90 degree for S462
R200 4620	Calibration S462
A4615	Sensor cable length extension (please inquire)
A554 3310	RS-485 splitter T, with 3 x M12 connectors to connect RS-485 devices to a bus



Portable set in transport casing. Can hold up to 4 units with battery pack, cables, charger and documentation



S462 powered by external power bank with connection cable A553 0156

Note: Power bank must be sourced locally due to shipping restrictions [USB-C, 20 V, min. 80 mA]

S211 / S215 / S220

Dew Point Transmitters

S211

-60 ... +20 °C Td

FOR DESICCANT DRYERS

S215

-20 ... +50 °C Td

FOR REFRIGERATION DRYERS

S220

-100 ... +20 °C Td

FOR HIGH-TECH APPLICATIONS



SIGNAL OUTPUT
4 ... 20 mA
Modbus/RTU



DISPLAY OPTION
For on-site values



COMPACT DESIGN
Makes it easy to fit into the application



PRESSURE SENSOR
integrated as option

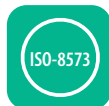

AIR QUALITY
Monitors humidity



PRECISE MEASUREMENT
± 2 °C Td
Accuracy



Benefits

- ✓ Compact size makes them ideal for dryer installations
- ✓ Optional display for on-site values. Display can be rotated by 340° to fit your needs
- ✓ User friendly signal outputs to connect to process controls or monitoring systems
- ✓ IP65 casing provides robust protection
- ✓ Low maintenance costs due to stable and reliable measurements which increase calibration intervals
- ✓ Measured values available in several units: °C Td • g/m³ • mg/m³ • ppmv • g/kg (@ reference pressure) • % rH and more, please ask our support for other measurement units

1 Reliable Measurement

SUTO can rely on a 20+ years experience in developing dew point sensors used in compressed air systems and pressurized gases. During that period of time, the engineers have continued to develop new measurement methods and even developed own sensor elements for our innovative dew point meters.

2 Various Output Signal

The Dew Point Meters are perfectly suited to be integrated into process controls or high-level monitoring systems. Various output options are offered for a seamless integration:

- 4 ... 20 mA 2-wire + SDI
- 4 ... 20 mA 3-wire + SDI
- 4 ... 20 mA 3-wire + Modbus/ RTU

3 Robust Materials

The main body is made from high class aluminum alloy with a soft finish. The process connection is a 1.4301 (SUS 304) stainless steel connection, made to last forever.

Top cover made from aluminum at the same quality as the main body. The optional display cover is made from robust Polycarbonate with ABS reinforcement to withstand the rough environment.

4 Display Option

The OLED display directly mounted on the device provides on-site real time values. The display can be easily rotated by 340° to fit your application.



5 S220 with unique QCM Sensor

Our QCM sensor is the result of years of high-tech research and development. The sensor was especially designed for low dew point applications where other sensor types fail.

The combination of QCM and the well known Polymer sensor makes the S220 the worlds first model to measure accurate over the whole range, from -100 °C Td up to +20 °C Td by switching automatically between the two sensor elements as needed.

Measurement Ranges and Applications

Model	S211	S215	S220
Dew point	-60 ... +20 °C Td	-20 ... +50 °C Td	-100 ... +20 °C Td
Temperature	-30 ... +70 °C	-30 ... +70 °C	-30 ... +70 °C
Pressure	0 ... 1.6 MPa	0 ... 1.6 MPa	0 ... 1.6 MPa
Application	In desiccant dryers	In fridge dryers	In high tech requirements and conditions

Modbus Sensor Network with S331

The Modbus/RTU bus allows to connect several devices to a single bus line via Daisy-Chain. For example up to 16 devices to a S331. The S331 is a very powerful yet cost effective new data logger and display solution.

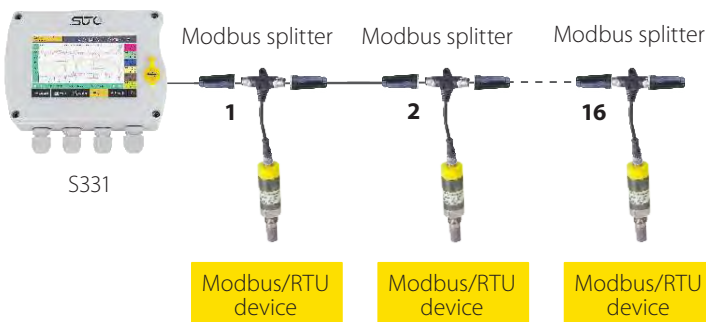

Exchange Service

No Downtime anymore!

The exchange calibration service eliminates down time and enables users to have a seamless record of their dew point measurements.

The user receives in advance a calibrated instrument with calibration certificate and the same instrument settings. The onsite instrument is then switched against the calibrated one and returned to the supplier.

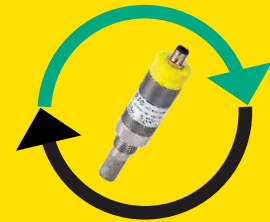

SUTO | Exchange Service

Dimensions

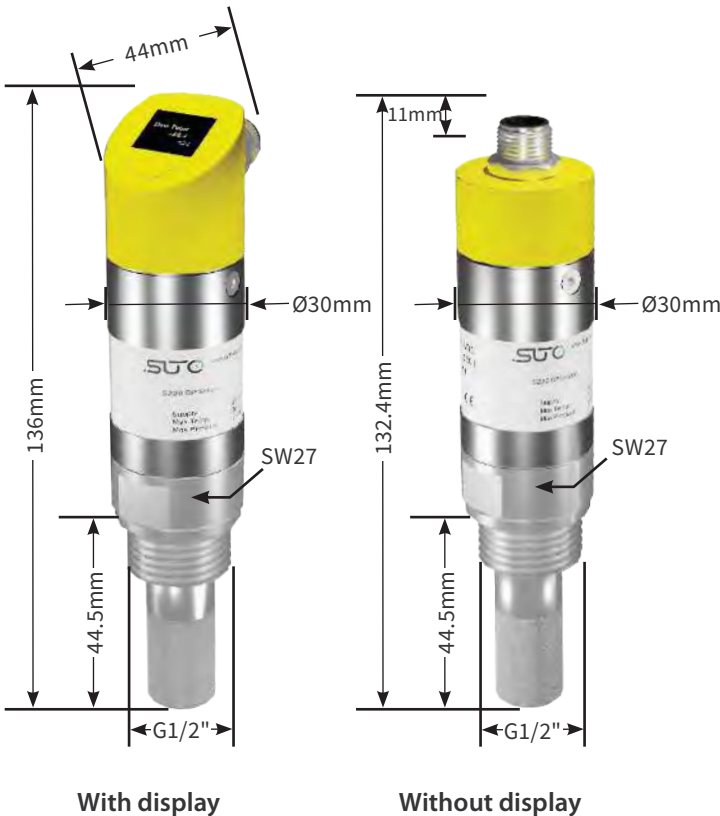

S220 with unique triple sensor solution

With the S220, SUTO is combining three sensors into a single measurement unit, making it unique and the most advanced sensor available on the market, with a full range of -100 ... +20 °C Td.

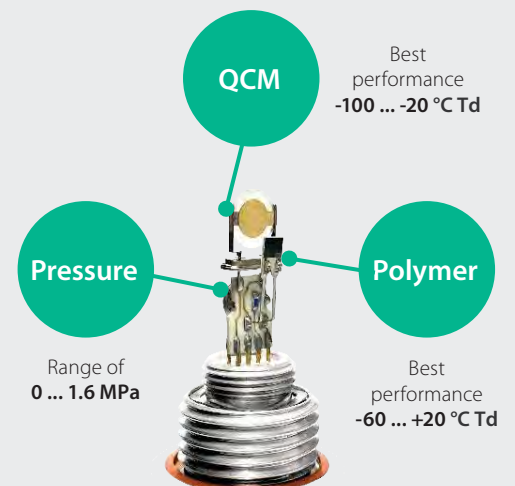

Technical Data

Specifications

Model	S211	S215	S220
Measurement Range	Dew point -60 ... +20 °C Td Temperature -30 ... +70 °C Pressure 0 ... 1.6 MPa	Dew point -20 ... +50 °C Td Temperature -30 ... +70 °C Pressure 0 ... 1.6 MPa	Dew point -100 ... +20 °C Td Temperature -30 ... +70 °C Pressure 0 ... 1.6 MPa
Dew point sensor	Polymer	Polymer	Polymer + QCM
Operating Pressure	-0.1 ... 1.6 MPa -0.1 ... 35.0 MPa optional	-0.1 ... 1.6 MPa -0.1 ... 35.0 MPa optional	-0.1 ... 1.6 MPa
Response time (t90)@4 l/min	0 °C Td → -60 °C Td ≤ 280 sec -60 °C Td → 0 °C Td ≤ 65 sec	0 °C Td → -20 °C Td ≤ 50 sec -20 °C Td → 0 °C Td ≤ 35 sec	0 °C Td → -80 °C Td ≤ 420 sec -80 °C Td → 0 °C Td ≤ 90 sec
Accuracy	Dew point +/- 1 °C Td (0 ... 20 °C Td) +/- 2 °C Td (-70 ... 0 / +20 ... +50 °C Td) +/- 3 °C Td (-100 ... -70 °C Td) Temperature +/- 0.3 °C Pressure 0.5 % FS		
Process connection	G 1/2" (ISO 228/1), stainless steel 1.4301 (SUS 304)		
Operating conditions	Medium Temp.: -30 ... +70 °C / Ambient Temp.: 0 ... +50 °C / Ambient Humidity: 0 ... 100 % rH		
Materials	Casing: Aluminum alloy / Process thread: Stainless steel 1.4301 (SUS 304) / Display cover: PC + ABS		
Classification / Approval	IP65 / CE		
Sensor protection	Sinter filter (stainless steel)		
Transport & Storage	Transport Temperature: -30 ... + 70 °C / Storage Temperature: -20 ... + 50 °C		
Weight	180 g		
Measured gases (Medium)	Air, Argon, O ₂ , N ₂ , CO ₂ *		
Output Signal	4 ... 20 mA 2-wire + SDI, 4 ... 20 mA 3-wire + SDI, 4 ... 20 mA 3-wire + Modbus/RTU		
Sensor types	Temperature sensor: Pt100 / Pressure sensor: Piezo resistive type		
Display option	0.66" OLED display, indicates the measured value and unit		
Supply Voltage	15 ... 30 VDC		

* CO₂ medium:

If the S211 is used in CO₂ the range is limited to -40 °C Td

The S211 and S220 must be set to CO₂ ex works or by using the S4C-DP Service Software + Service Kit (please state at the order if S211 and S220 will be used in CO₂)

Accessories



Measuring chamber for easy installation through quick coupling



By-pass measuring chamber with 6 mm hose connections as in- and outlet



High pressure measuring chamber for applications up to 35.0 MPa



M12 Sensor cable with open ends 5 m or 10 m

Ordering

Please use the following tables to assist in placing your order with our sales staff.

	2-wire Analog & SDI output	3-wire Analog & SDI output	3-wire Analog & Modbus/RTU* ³ output	3-wire Analog & Modbus/RTU* ³ output With Pressure Sensor
Transmitter Model and Range	Order No.	Order No.	Order No.	Order No.
S215 Dew Point Transmitter -20 ... +50 °C Td	S699 1215	S699 2215	S699 3215	S699 4215
S211 Dew Point Transmitter -60 ... +20 °C Td	S699 1211	S699 2211	S699 3211	S699 4211
S220 Dew Point Transmitter -100 ... +20 °C Td	S699 1220	S699 2220	S699 3220	S699 4220
Options				
Operating Pressure 0 ... 1.6 MPa (Standard)	A1380	A1380	A1380	A1380
Operating Pressure 0 ... 35.0 MPa	A1381* ¹	A1381* ¹	A1381* ¹	N/A* ²
Without Display (Standard)	A1389	A1389	A1389	A1389
With OLED Display	N/A* ²	A1387	A1388	A1388

*¹ A1381: The high pressure option is only available for the models S215 and S211. The S220 can not be used in pressure applications > 1.6 MPa

*² N/A: This option is not available for these models

*³ Standard Modbus/RTU Settings are Slave Address: last two digits of serial number / Com. Settings: 19200 baud, 8/N/1

Order Example

Model:	S211 -60...+20 °C Td, 3-wire analog & Modbus/RTU, 0...1.6 Mpa operating pressure, without display
Code:	S699 3211.A1380.A1389

Output Unit

The dew point Transmitter is available with different measurement units for dew point, humidity, temperature and pressure. Standard is: **Dew point = °C Td / Temperature = °C / Pressure = bar**
If you would like to have a different unit as output, please specify it at the order or use the optional Service Kit with the Service Software to change the output unit. For example pressure in PSI or humidity in ppmv.

Accessories

Order No.	Description
A699 3491	Measuring chamber with quick connector, up to 1.6 MPa, 2 l/min purge @ 0.8 MPa
A699 3493	Measuring chamber by-pass, up to 1.6 MPa, 6 mm hose connection as in- and outlet
A699 3590	High pressure measuring chamber, up to 35.0 MPa, G 1/4" inner thread process connection
A553 0104	Sensor cable, 5 m with M12 connector, open wires, AWG 24 (0.2 mm ²)
A553 0105	Sensor cable, 10 m with M12 connector, open wires, AWG 24 (0.2 mm ²)

Calibration

Order No.	Description
R699 3396	Re-calibration dew point transmitter, incl. certificate of calibration

Similar to illustration and pictures / MODBUS® Bluetooth® word mark and logos
Registered trademark of the Modbus Organization, Hopkinton, USA

S230 / S231

Dew Point Transmitters for Ex Applications

S230

-100 ... +20 °C Td

S231

-50 ... +20 °C Td



EX APPROVED
IECEX, ATEX &
GB Ex



PRECISE MEASUREMENT
Unique QCM
sensor technology



LOW DEW POINT
Measures down
to -100 °C Td

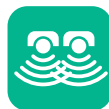

DUAL SENSOR SYSTEM
High precision
over the whole range



Benefits

- ✔ Dew Point Transmitter made for Ex-Applications (IECEX, ATEX, GB Ex)
- ✔ Robust enclosure for the use rough industrial environments
- ✔ Dual sensor technology for the highest accuracy over the full range of -100 ... +20 °C Td
- ✔ G1/2" Stainless steel process connection
- ✔ 4 ... 20 mA analog and Modbus/RTU digital outputs for highest flexibility

Reliable dew point monitoring

The S230 / S231 dew point sensor from SUTO offers reliable and customer-oriented measurement technology in a robust housing. The sensor is used in harsh industrial environments and, thanks to the compact housing, offers easy integration into existing processes.

The unique dual sensor system combines two measurement methods in one sensor. The sensor offers highest precision and accurate measurement results over the entire measuring range. The intelligent measurement technology automatically selects the appropriate measurement method, thus ensuring the reliability of the measurement results.

The S230 / S231 is preset at the factory and is ready for immediate use. The output signals available are an analog 4 ... 20 mA signal and a digital Modbus/RTU signal. We will be pleased to set the parameters to suit your application. Alternatively, you have full access to all settings via the service kit.

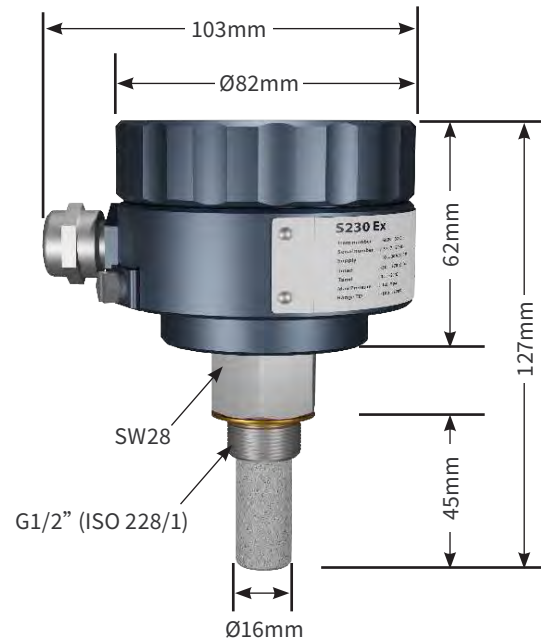

Accessories

Measuring chamber with inlet / outlet valve and compression fitting for gas supply



Cable connection



Screw terminals with signal labels inside the connection chamber

Technical Data

Measurement

Dew Point

Accuracy	± 1 °C Td (0 ... 20 °C Td) ± 2 °C Td (-60 ... 0 °C Td) ± 3 °C (-100 ... -60 °C Td)
Selectable units	°C, °F, bar(g), MPa(g), psi(g), % rH, g/m ³ , mg/m ³ , G/m ³ atm., mg/m ³ atm., ppm(v), g/kg, °C Td atm.
Measuring range (model depending)	S230: -100 ... +20 °C Td S231: -50 ... +20 °C Td
Sensor	Polymer + QCM
Response time t90 (@ 4l/min)	-20 °C Td → -60 °C Td = < 240 sec -60 °C Td → -20 °C Td = < 30 sec

Temperature

Accuracy	0.3 °C
Measuring range	-30 ... +70 °C
Sensor	NTC

Reference conditions

Selectable conditions	Pressure Dew Point, Atmospheric Dew Point
-----------------------	--

Signal / Interface & Supply

Analog output

Signal	4 ... 20 mA (isolated) Modbus/RTU
Scaling	S230: 4 mA = -100 °C Td; 20 mA = +20 °C Td S231: 4 mA = -50 °C Td; 20 mA = +20 °C Td
Load	250R
Update rate	3/sec

Fieldbus

Protocol	Modbus/RTU
Update rate	1/sec

Supply

Voltage supply	10 ... 30 VDC
Current consumption	45 mA @ 24 VDC

General data

Configuration

PC Software	S4C-DP Application
-------------	--------------------

Material

Process connection	Stainless steel 1.4301 (SUS 304)
Housing	Aluminium alloy
Sensor	Polymer, Ceramic

Miscellaneous

Electrical connection	Screw terminals
Protection class	IP67
Approvals	II 2G Ex db ib IIC T4 Gb II 2D Ex ib tb IIIC T135°C Db CE

Process connection	G 1/2" thread (ISO 228/1)
--------------------	---------------------------

Weight	728 g
--------	-------

Operating conditions

Medium	Air, Argon, O ₂ , N ₂ , CO ₂ *
Medium quality	ISO 8573-1: 4.6.3 or better
Medium temperature	-30 ... +70 °C
Medium humidity	≤ 20 °C Td
Operating pressure (model depending)	-0.1 ... 1.6 MPa (S230) -0.1 ... 35 MPa (S231)
Ambient temperature	-20 ... +50 °C
Ambient humidity	0 ... 100 % rH
Storage temperature	-20 ... +50 °C
Transport temperature	-30 ... +70 °C

Stated accuracy under following conditions:

- Ambient temperature 23 °C ±3 °C
- Process temperature 23 °C ±3 °C
- Ambient humidity < 95 %, no condensation
- Airflow > 2 l/min at sensor tip

Ordering

Please use the following tables to assist in placing your order with our sales staff.

S230 Dew Point Transmitter (-100 ... +20 °C Td)

Order No.	Description
S699 0230	S230 Dew Point Transmitter, -100 ... +20 °C Td, G 1/2" thread, 1.6 MPa, 1 x 4 ... 20 mA, RS-485 (Modbus)
A1480	Ex option ATEX
A1481	Ex option IECEx
A1482	Ex option GB3836

S231 Dew Point Transmitter (-50 ... +20 °C Td)

Order No.	Description
S699 0231	S231 Dew Point Transmitter, -50 ... +20 °C Td, G 1/2" thread, 35 MPa, 1 x 4 ... 20 mA, RS-485 (Modbus)
A1480	Ex option ATEX
A1481	Ex option IECEx
A1482	Ex option GB3836

Accessories

Order No.	Description
A554 2301	Measuring chamber with inlet / outlet valve and compression fittings for gas supply, 1.6 MPa
A554 2302	Measuring chamber with insertion type sampling tubes (for applications where purge losses are not acceptable), 1.6 MPa
A699 3491	Measuring chamber with quick connector, up to 1.5 MPa, 2 l/min purge @ 0.8 MPa
A699 3493	Measuring chamber by-pass, up to 1.5 MPa, 6 mm hose connection as in- and outlet

S305

Dew Point Monitor

Opt. 1

-50 ... +20 °C Td

Opt. 2

-20 ... +50 °C Td



PLUG & PLAY
Simply connect your compressed air



DEW POINT MEASUREMENT
-50 ... +50°C Td depending on the model



PRECISE MEASUREMENT
± 2°C Td accuracy

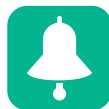

ALARM INDICATION
With internal relays or alarm units



Benefits

- ✓ Plug & Play solution, no need for complicated setup and installation
- ✓ 6 mm hose connection with quick coupling for most convenient installation
- ✓ Two ranges available:
-20 ... +50 °C Td for fridge driers
-50 ... +20 °C Td for desiccant driers
- ✓ Wall mountable housing with a big display and optional alarm unit
- ✓ 4 ... 20 mA output to connect it to a PLC or BMS system
- ✓ Easy alarms set up for pre- and main alarm

Refrigeration dryers are the most commonly used dryer type in compressed air system around the world. If the required drying is not achieved, the impact of wet air can be serious: Rust in the pipes, failures of machines, and a negative impact on product quality.

SUTO offers with the S305 a measuring device for dew point monitoring that kicks in alarm indications when drying values are not within the desired range.

2 Models

-50 ... +20 °C Td and -20 ... +50 °C Td

1 Dew Point Sensor

Reliable polymer dew point sensor with integrated measuring chamber for accurate readings and fast response time

2 Robobust Casing

The entire measuring unit is integrated together with the display in a rugged housing (IP65)

3 Power Supply

100 ... 240 VAC or 24 VDC

4 Output

4 ... 20 mA output to PLC or SCADA system

5 Connection

The connection to the compressed air network is via a 6-mm quick connect and corresponding connecting hose.



Dimensions



Pre- and Main-Alarm programmable

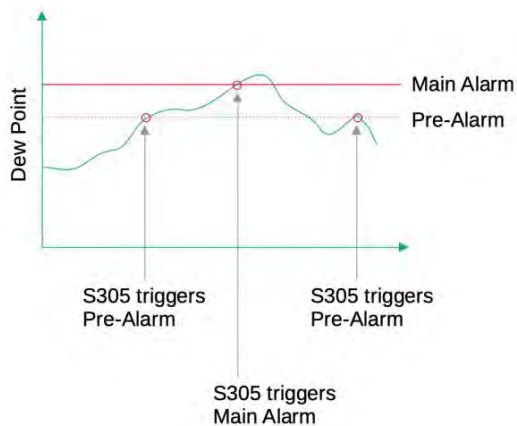

Two alarm levels can be programmed (pre and main alarm), serving an optical indications or separate relay outputs.

Exchange Service

No Downtime anymore!

The exchange calibration service eliminates down time and enables users to have a seamless record of their dew point measurements.

The user receives in advance a calibrated sensor unit with calibration certificate and the same sensor settings. The onsite sensor is then switched against the calibrated one and returned to the supplier.

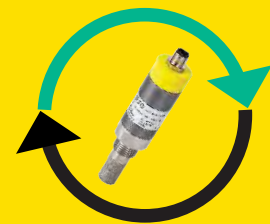

.STO | Exchange Service

Installation

S305 is designed to be Plug & Play. There is no need for complicated setup or configuration. Simply connect your compressed air and start measuring.

Optional Alarm Unit

Wall mounted housing with a big display for dew point, temperature and humidity. The optional alarm unit can be wall mounted or mounted directly on the housing. The 360° visible LED and the alarm buzzer indicate alarms reliably.



Technical Data

Measurement

Dew Point

Accuracy	±2 °C Td
Selectable units	°C, °F
Measuring range (model depending)	-50 ... +20 °C Td -20 ... +50 °C Td
Sensor	Polymer
Response time t90 (@ 4l/min)	-50 °C Td → -20 °C Td = 20 sec 0 °C Td → -40 °C Td = 120 sec

Temperature

Accuracy	0.3 °C
Measuring range	-30 ... +70 °C
Sensor	NTC

Reference conditions

Selectable conditions	Pressure Dew Point
-----------------------	--------------------

Signal / Interface & Supply

Analog output

Signal	4 ... 20 mA 3-Wire
Scaling	-50 ... +20 °C Td or -20 ... +50 °C Td
Load	250R
Update rate	3 / sec

Supply

Voltage supply (model depending)	100 ... 240 VAC ; 50/60 Hz 24 VDC
Current consumption (model depending)	40 mA @ 220 VAC 120 mA @ 24 VDC

General data

Configuration

PC Software	S4C-Display Software
Others	Instrument comes pre-configured Plug & Play

Display

Integrated	LCD Display, indicates values and alarms
------------	--

Material

Process connection	Stainless steel 1.4301 (SUS 304)
--------------------	----------------------------------

Housing	ABS, Aluminium alloy
---------	----------------------

Sensor	Polymer
--------	---------

Metal parts	Sinter Filter (stainless steel)
-------------	---------------------------------

Miscellaneous

Electrical connection	Screw terminals
-----------------------	-----------------

Protection class	IP65
------------------	------

Approvals	CE
-----------	----

Process connection	6 mm quick connector
--------------------	----------------------

Weight	520 g
--------	-------

Operating conditions

Medium	Non-corrosive gases
--------	---------------------

Medium quality	ISO 8573-1: 4.6.3 or better
----------------	-----------------------------

Medium temperature	-30 ... +70 °C
--------------------	----------------

Medium humidity	≤ 20 °C Td or ≤ 50 °C Td (model depending)
-----------------	---

Operating pressure	0.3 ... 1.5 MPa
--------------------	-----------------

Ambient temperature	-10 ... +40 °C
---------------------	----------------

Ambient humidity	0 ... 100 % rH
------------------	----------------

Storage temperature	0 ... +40 °C
---------------------	--------------

Transport temperature	-30 ... +70 °C
-----------------------	----------------

Stated accuracy under following conditions:

- Ambient temperature 23 °C ±3 °C
- Process temperature 23 °C ±3 °C
- Ambient humidity < 95 %, no condensation
- Airflow > 2 l/min at sensor tip

Ordering

Please use the following tables to assist in placing your order with our sales staff.

S305 Dew Point Monitor (-50 ... +20 °C Td / -20 ... +50 °C Td)

Order No.	Description
D699 3050	S305, Dew Point Monitor, -20 ... +50 °C Td, 6 mm quick connector, 15 bar, 1 x 4 ... 20 mA, 100 ... 240 VAC, 2 relay outputs
D699 3051	S305, Dew Point Monitor, -20 ... +50 °C Td, 6 mm quick connector, 15 bar, 1 x 4 ... 20 mA, 24 VDC, 2 relay outputs
D699 3052	S305, Dew Point Monitor, -50 ... +20 °C Td, 6 mm quick connector, 15 bar, 1 x 4 ... 20 mA, 100 ... 240 VAC, 2 relay outputs
D699 3053	S305, Dew Point Monitor, -50 ... +20 °C Td, 6 mm quick connector, 15 bar, 1 x 4 ... 20 mA, 24 VDC, 2 relay outputs

Accessories

Order No.	Description
A554 0024	Alarm unit, 100 ... 240 VAC, red light and buzzer alarm, wall mountable (unit is using the relay outputs of S305 to trigger the alarm)
A554 0025	Alarm unit, 100 ... 240 VAC, red light and buzzer alarm, mounted at S305 casing (unit is using the relay outputs of S305 to trigger the alarm)
A553 0106	Power cable with mains plug, 1.8 m

S520

Portable Dew Point Meter



Opt. A

-100 ... +20 °C Td

Opt. B

-50 ... +50 °C Td



SMART DEVICE

Dew point prediction



TOUCH SCREEN

Intuitive user interface



PRESSURE SENSOR

Enables various humidity units

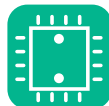

DATA LOGGER

Integrated mass storage



LOW DEW POINT

Measures down to -100 °C Td



CAMERA INTEGRATED

Pictures for better reports



PORTABLE UNIT

Handheld unit within a rugged case

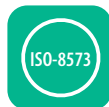

DEW POINT AUDITS

Indication of class on display



Benefits

- ✓ Easy to use portable meter to measure dew point, temperature and pressure on site
- ✓ Sensor selection according to your needs (-100 ... +20 °C Td with pressure sensor / -50 ... +50 °C Td version)
- ✓ ISO 8573 class measurements with powerful ISO 8573-1 PDF reporting function
- ✓ Wireless printer for on-site reporting to easily perform audits
- ✓ Unique Measuring chamber with parking function supports fast response times
- ✓ Optional smart features: End value prediction, camera and measurement snapshot

1 Dew Point Value Prediction

The S520 offers a unique dew point end value prediction algorithm as a built-in technology.

Based on the dew point measurement curve our algorithm is able to predict the end value before actually reaching the end value.

This feature enables the user to predict the dew point end value in a minimum amount of time. It helps on-site engineers to save time and to perform faster dew point audits.

Smart Features

Dew point end value prediction is a part of the smart features. With the smart features option, users also get a 5 Megapixel camera and the snapshot function for quick measurement logging.

2 Measurement Snapshot

Take a quick measurement snapshot of the current measurement, add the customer information and easily create a printed report.

All can be done on the device via touchscreen input.

3 Measurement Chamber

The unique measuring chamber with integrated parking function enables users time efficient dew point measurements.

When the instrument is not used, the measuring chamber can be set to parking position. In this state, the sensor is exposed to a desiccant, which keeps the sensor well protected and dry.

When starting the next measurement, the sensor is pre-dried and has therefore an ultra-fast response time, perfect for air audits.

4 Unique SUTO Triple-Sensor

S520 is equipped with the SUTO QCM, the Polymer and an integrated Pressure sensor.

Our QCM sensor is the result of years of high-tech research and development. The sensor was especially designed for low dew point applications where other sensor types fail.

The combination of QCM and the well known Polymer sensor makes the S520 measure accurate over the whole range, from -100 °C Td up to +20 °C Td by switching automatically between the two sensor elements as needed. At the same time the line pressure is measured.



Application: Compressed Air Quality Monitoring On Site

The S520 Portable Dew Point Meter enables more accurate and frequent quality monitoring to operators. Throughout any given day, plant personnel can check the dew point throughout their system, using the S520's detailed metrics and portability to gather useful information from even the least accessible corners of their system.

With the S520, operators can make sure that their compressed air treatment system (air dryers, filters, and drains) is functioning at its absolute peak. If the S520 reveals heightened moisture levels at any point during the routine check, personnel can quickly locate and resolve the issue, reducing instances of clogged filters and dryer problems.

Optional Printer

Wireless printer used to print the measurement results on site. Perfect solution for quick audits.



Exchange Service

No Downtime anymore!

The exchange calibration service eliminates down time and enables users to have a seamless record of their dew point measurements.

The user receives in advance a calibrated instrument with calibration certificate and the same instrument settings. The onsite instrument is then switched against the calibrated one and returned to the supplier.

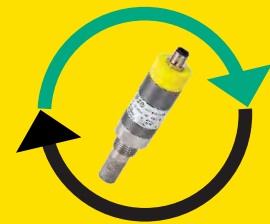

SUTO | Exchange Service

PDF Report Function according to ISO 8573-1

Create powerful PDF Reports on-site according to the ISO 8573-1 standard.

The reports are following the recommendations stated in the ISO 8573-1, additionally customer related data as well as service provider details can be entered on-screen, making it even easier to perform audits and to create meaningful reports.

PDF reports can be created from any recordings on the device and are copied on the fly to a connected USB drive.

The declared Pressure dew point in °C is stated as the measured dew point under actual conditions as well as referring to reference conditions at 20 °C/7 bar(g), as it is required by ISO 8573-1 standard. This is only possible, thanks to the integrated pressure sensor on the S520.

Air Purity Report
S520 Portable Dew Point Meter

Measurement device
Model: S520
Manufacturer: SUTO ITEC
Last calibration: 22. June 2022
Serial number: 1234 5678

Location information
Customer: Customer GmbH
Tester name: Max Mustermann
Measurement Location: Prod. Line 1
Measurement Point: Maschine 1

Target classes ISO 8573-1 (selected by user)
Humidity: 1

Measurement results
System / Measurement conditions
Medium Temperature [°C]: 31.0
Medium Pressure [bar]: 5.62

Declared Pressure dew point in °C (referring to actual and reference conditions 20 °C, 7 bar(g))¹⁾

Reference conditions	Measured value	Limit value	ISO 8573-1 Class (pass/fail)
Actual conditions	N.S. ²⁾	-24.6	N.S. ²⁾
20°C / 7 bar(g)	5 -20.0	-22.7	passed

Measurement equipment
Pressure dew point: Polymer + QCM sensor Accuracy: ± 2 °C Range: 0/1...+30 °C/°F

Approval
Signature Tester: _____ Signature Customer: _____ Place / Date: _____

Notes/Comments:



Be smart. Measure it.

Service provider
Company: SUTO ITEC GmbH
Phone: 0049 7634 504 88 00
Email: info@suto-itec.com

Measurement information
Measurement started: 14:56:00 22. August 2021
Measurement stopped: 15:26:00 22. August 2021
Measurement duration: 00:30:00

Gas Type: Air

1) For further details, please check the calibration certificate.
2) According to ISO 8573-1 the declared pressure dew point at 20 °C and 7 bar(g) must be based on an ISO 8573-1 measurement unit. The pressure dew point at listed conditions must be referred to the background.

Technical Data

Measurement

Dew point

Accuracy	± 1 °C Td (0 ... 20°C Td) ± 2 °C Td (-70 ... 0 / +20 ... +50 °C Td) ± 3 °C Td (-100 ... -70°C Td)
----------	---

Selectable units	%rH, °C Td, g/m ³ , mg/m ³ , g/m ³ atm., ,mg/m ³ atm. , ppmv, g/kg, °C Td atm.
------------------	---

Measuring range	Sensor A: -100 ... +20 °C Td Sensor B: -50 ... +50 °C Td
-----------------	---

Repeatability	0.5 °C
---------------	--------

Sensor	Sensor A: QCM + Polymer Sensor B: Polymer
--------	--

Pressure

Accuracy	0.5 % FS
----------	----------

Measuring range	0 ... 1.5 MPa (g)
-----------------	-------------------

Sensor	Piezo resistive sensor
--------	------------------------

Temperature

Accuracy	± 0.3 °C
----------	----------

Measuring range	-30 ... +50 °C
-----------------	----------------

Sensor	PT 100
--------	--------

Interface & Supply

Supply

Power supply	USB charger: 5 V, 3 A Connector: USB-C
--------------	---

Operating time	8h
----------------	----

Data interface

Connection	USB
------------	-----

* At least 0.3 MPa(g) is needed for the measuring chamber supplied with the instrument. For low-pressure measurements below 0.3 MPa (g) choose the optional bypass measuring chamber A699 3501.

General data

Display

Integrated	3.5" color LCD touch screen
------------	-----------------------------

Data Logger

Storage	Integrated mass storage, up to 30 million recorded data sets (4 channels each)
---------	--

Material

Housing	PC + ABS
---------	----------

Metal parts	Aluminium
-------------	-----------

Miscellaneous

Protection class	IP30
------------------	------

Approvals	CE
-----------	----

Weight	2.7 kg complete set in transport case
--------	---------------------------------------

Operating conditions

Medium	Air, N ₂ , O ₂ , Argon, CO ₂ Note: The CO ₂ measurements with the A1371 sensor are limited to -40 °C Td.
--------	--

Medium temperature	-30 ... +50 °C
--------------------	----------------

Medium humidity	0 ... 90 %, no condensation
-----------------	-----------------------------

Operating pressure	-0.1 ... 1.6 MPa (g)*
--------------------	-----------------------

Ambient temperature	0 ... +40 °C
---------------------	--------------

Ambient humidity	0 ... 80 % rH
------------------	---------------

Storage temperature	-20 ... +50 °C
---------------------	----------------

Transport temperature	-30 ... 70 °C
-----------------------	---------------



Ordering

Please use the following tables to assist in placing your order with our sales staff.

S520 Portable Dew Point Meter

Order No.	Description
	S520 Handheld Dew Point Meter with data logger
	<u>Including:</u>
P600 0520	<ul style="list-style-type: none"> Measuring chamber with parking function 1.5 m PTFE hose 6 mm with quick coupling, USB-OTG memory stick USB charger with USB-C cable Certificate of calibration Transport casing
Measuring range (Sensor unit)	
A1370	-100 ... +20 °C Td Standard range sensor unit, with integrated pressure sensor -0.1 ... 1.5 MPa
A1371	-50 ... +50 °C Td Economic range sensor unit, without integrated pressure sensor
Wireless printer	
A1374	Without printer
A1372	With wireless printer for measurement printouts on site
Smart feature	
A1375	Without smart features
A1373	With smart features (Measurement snapshot, Dew point end value prediction, Camera)

S520 Accessories

Order No.	Description
A699 3501	By-pass measuring chamber with parking function, 0 ... 1.0 MPa, 6 mm hose quick connector as in- and outlet
A554 0021	Paper rolls for wireless printer

Example: S520 Handheld Dew Point Meter with data logger, -100 ... +20 °C Td Sensor, Without printer, With smart features

Order Code: P600 0520.A1370.A1374.A1373

Scope of delivery

S520



Unique measuring/parking chamber for fast sensor response



The included transport case protects the instrument. At the same time it holds all accessories.



Memory stick



PTFE hose with quick connect



USB charger with USB-C cable

S330/S331

Display and Data Logger



S330

Display

S331

Display & Data Logger

IIoT

IIOT SUPPORT
Connection to S4M software



TOUCH SCREEN
5" large color LCD



WEB SERVER
Access from world wide



VERSATILE CONNECTION
Up to 16 sensors inputs



TIGHT PROTECTION
IP65



DATA LOGGER
100 million values



Benefits

- ✔ Central unit of a compressed air monitoring system, collecting, recording and visualizing all measurement data
- ✔ High-resolution 5" color touch screen for easy operation and on-site data visualization
- ✔ Connect up to 16 Modbus/RTU sensors, 2 analog sensors and 2 SDI sensors to a single data logger
- ✔ Modbus/RTU and Modbus/TCP output always included for a seamless integration into existing monitoring and building management systems
- ✔ Alarm monitoring for all measurement channels with on-screen indication and 2 relay outputs

Plug and Play Data Logging – Process Visualization and Analysis

The S330/S331 Display and Data Logger provides an universal solution for displaying and recording all relevant parameter of a compressed air system, which includes flow, dew point, pressure, temperature, power consumption, compressor status, and so on. The devices offer a powerful yet cost efficient data logger and display solution for optimal and reliable management and monitoring of your compressed air system.

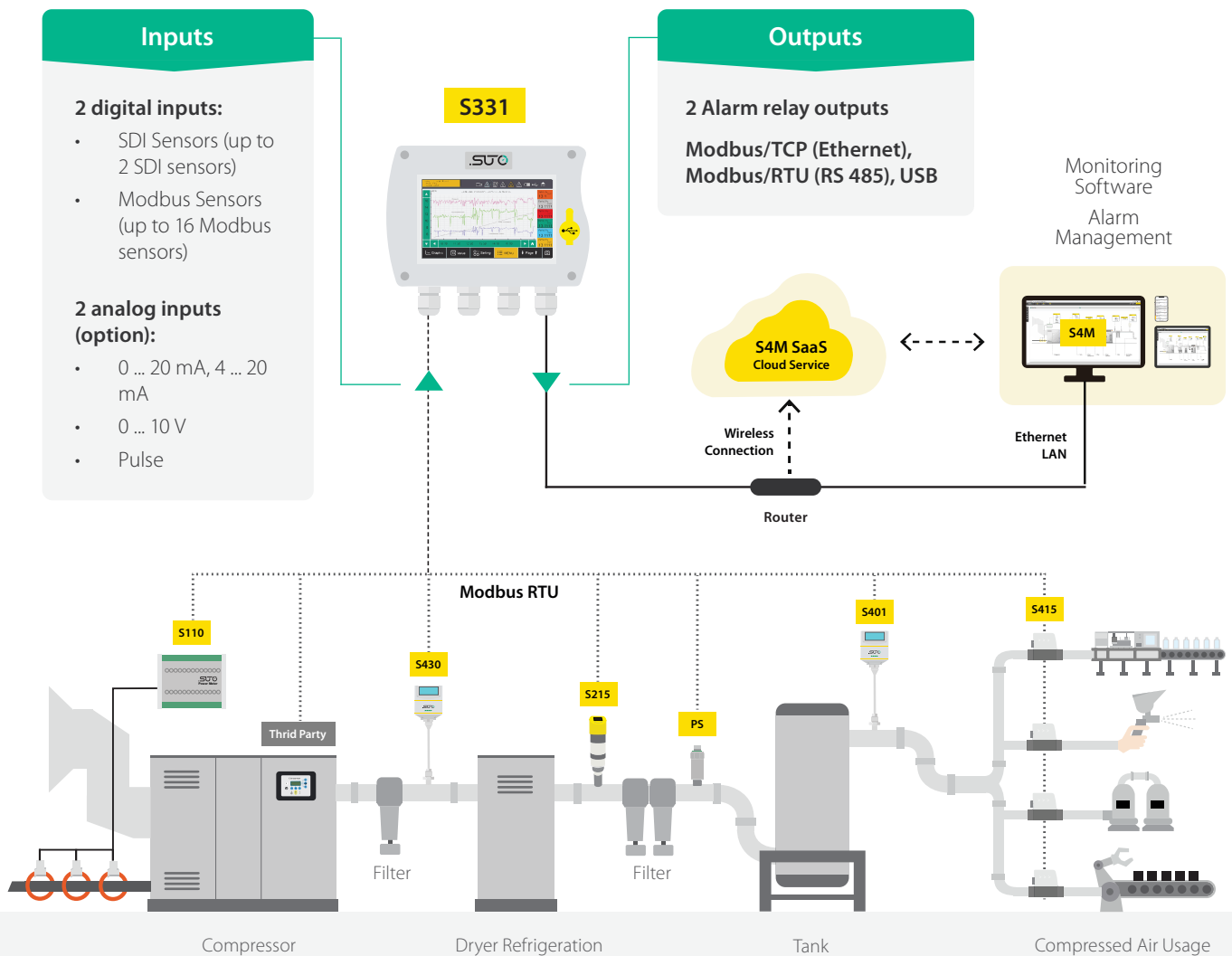

Applications

The S331 Display and Data Logger is used to gather and collect measurement data of various field devices. It acts as the central unit where all measurement data is safely stored and visualized. The digital communication outputs are not making it a display and data logger, but also a gateway to connect to IIoT services, as well as to connect it to modern software solutions



Available Installation Options



2 different wall mountable casings to fit customers needs.



The Display can be installed in existing wall cabinets or machines via panel mounting options.



The DIN rail option is used to install the Display inside of electrical cabinets.

1 SUTO Modbus/RTU Sensor Input

The S330 / S331 includes digital inputs for SUTO SDI sensors and Modbus/RTU sensors. To connect the Modbus/RTU sensors properly on an RS 485 bus system, it's recommended to daisy-chain the sensors to one of the inputs. For this purpose, SUTO offers a RS 485 splitter to simplify the connection.

Through this method, users can add up to 16 sensors to the master input, making it most versatile and allowing to monitor whole plants with a single data logger. (Additional power supplies for field devices might be necessary)

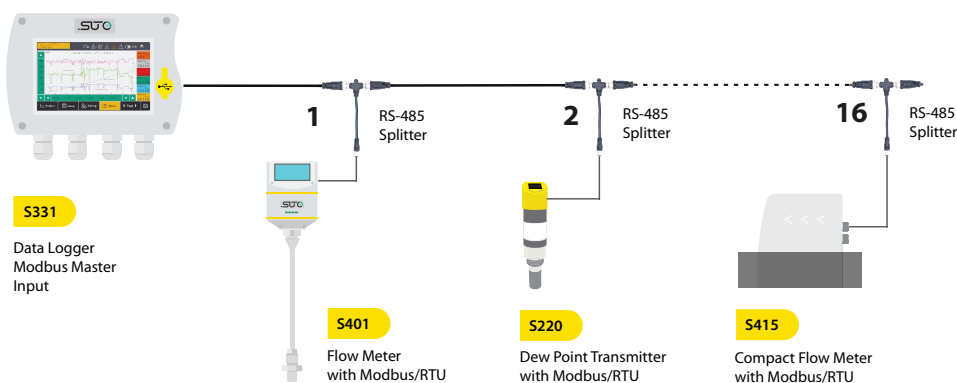

2 Analog Sensor Input

The S330 / S331 can be equipped with an analog input option, allowing to connect 0/4... 20 mA, 0...10 V and pulse signals from field sensors. If more analog sensors need to be connected, a Analog-Modbus/RTU converter module can be easily connected, allowing to connect additionally 8 analog sensors.

This makes the S330 / S331 most versatile and offers the possibility to connect existing field hardware and sensors seamlessly into the monitoring system.

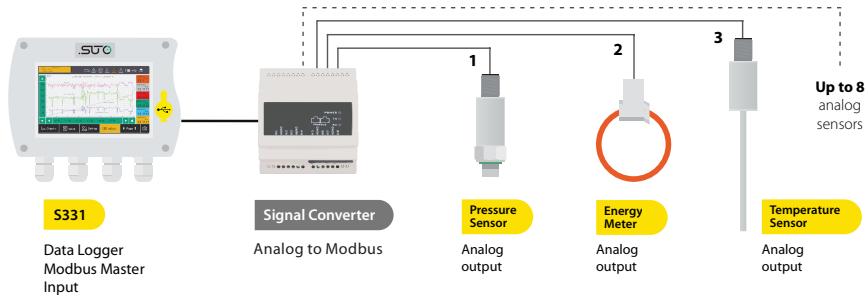

3 Third-Party Sensor and Field Device Support

By relying on the industry standard protocol Modbus/RTU, the S330 / S331 does support third-party sensors to be easily integrated into the monitoring system. Field devices can be easily set up using the configuration software, allowing to add third-party sensor within seconds.

Of course, all connected sensor data can be logged to the internal memory, used for virtual channel calculations and real-time values are forwarded to connected software and monitoring solutions.

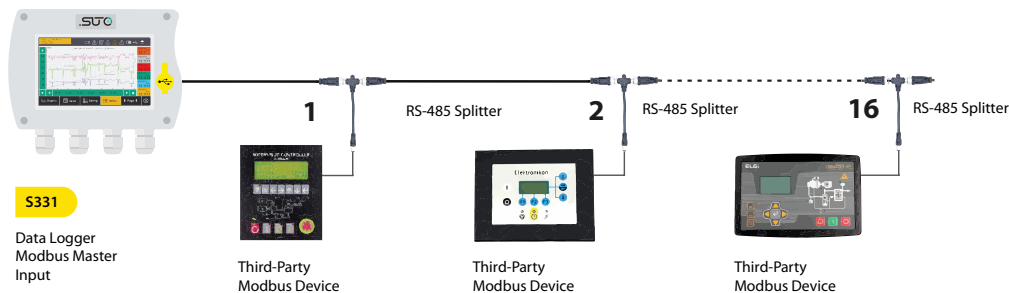

Data Analysis

Through the free SUTO S4A software recordings are downloaded to the PC via USB, LAN or wirelessly using the LTE/4G Modem. The basic analysis can be done in S4M.

For more sophisticated compressor analysis, the SUTO CAA software (incl. in S551) offers many advanced features such as:

- Performance statistics of compressors (efficiency, air delivery, load/unload cycles)
- Leakage analysis
- Report generation
- and more...

Comparisons with baseline measurements from last year or last month help to identify system changes.

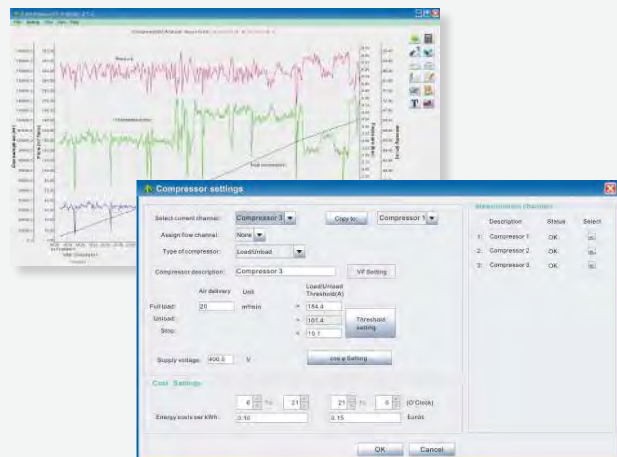

User Friendly Handling

The S330 / S331 comes with a high resolution 5" color touch screen interface making the operation as simple as possible.

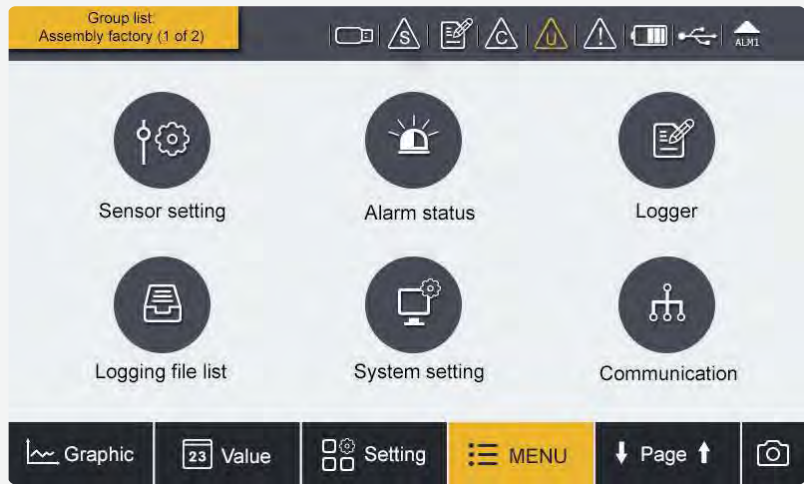

Sensor Data Overview

Up to 4 sensors can be viewed on one page and through page scrolling further sensors can be displayed.

This makes it easy to monitor different sensors at the same time.

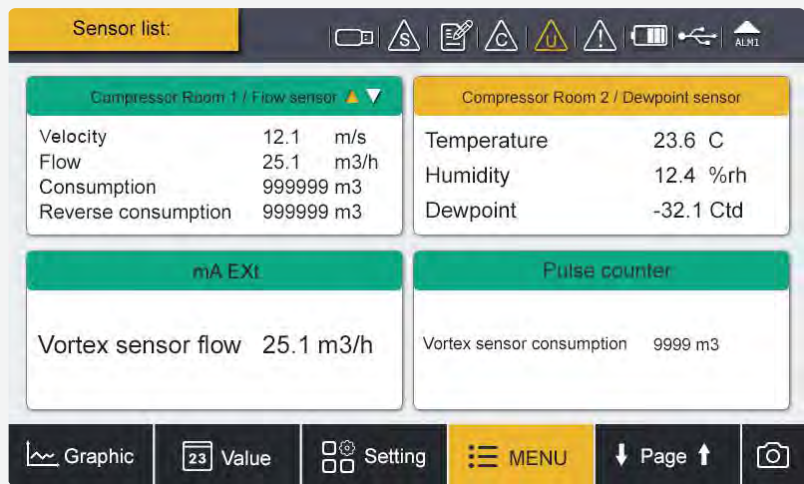

Graphic Charts for Quick Analysis

Select which channels you want to view or analyze and the built in graphic analyzer will help you identify problems immediately.

For detailed analysis we recommend using SUTO S4M software.

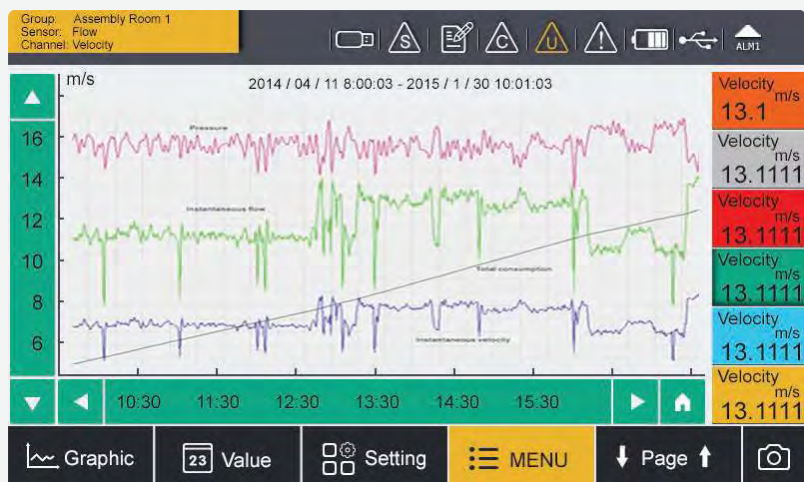

Technical Data

Signal / Interface & Supply

Data logger

Storage	Internal, up to 100 million values
Sampling rate	Optional $\geq 1s$, Max 59mm:59ss

Input signals

Digital input	2 x SDI sensors 16 x RS-485 Modbus RTU Sensors 2 x 0 ... 20 mA / 4 ... 20 mA / 0 ... 10 V
---------------	---

Analog input	2 x 0/4 ... 20 mA; 2 x 0 ... 10 V; 2 x pulse
--------------	---

Pulse input	100 Hz maximum; 28 V, 10 Ma
-------------	-----------------------------

Output signals

Analog / Pulse output	4 ... 20 mA signal and pulse signal of sensors can be looped through the display by using the connection board
-----------------------	--

Alarm output	2 relays, 230 VAC, 3 A, NC
--------------	----------------------------

Field bus Interface

Protocol	Modbus/TCP (Ethernet), Modbus/RTU (RS 485)
----------	---

Electrical data

Power supply	100 ... 240 VAC, 20 VA (option, A1663) 18 ... 30 VDC, 20 W (option, A1664)
--------------	---

Sensor supply	24 V, 10 W
---------------	------------

Data interface

Connection	Modbus/TCP (Ethernet), Modbus/RTU (RS 485), USB
------------	--

General data

Configuration

PC Software	S4C-Display software
-------------	----------------------

Display

Integrated	Size: 5" high-resolution graphic display Resolution: 800 x 480 pixels touch screen
------------	---

Material

Housing	PC + ABS
---------	----------

Miscellaneous

Electrical connection	Screw-Terminal connectors
-----------------------	---------------------------

Protection class	IP65
------------------	------

Approvals	CE
-----------	----

Weight	0.52 kg
--------	---------

Housing	Panel, wall mountable
---------	-----------------------

Dimensions	See dimensional drawing
------------	-------------------------

Cable entry diameter	4.5 ... 8 mm
----------------------	--------------

Cable	Supply: AWG 12 ... AWG 24, 0.2 ... 2.5 mm ² ; Signals: AWG 16 ... AWG 28, 0.14 ... 1.5 mm ²
-------	--

Weight	0.52 kg
--------	---------

Operating conditions

Ambient temperature	0 ... +50 °C
---------------------	--------------

Ambient humidity	< 90 %
------------------	--------

Storage temperature	-20 ... +70 °C
---------------------	----------------

Transport temperature	-20 ... +60 °C
-----------------------	----------------

Ordering

Please use the following tables to assist in placing your order with our sales staff.

S330 / S331 Display and Data Logger

Order No. Description

D500 0333	S330 Display, Panel Version, 2 x SDI & 16 x Modbus/RTU input, Ethernet, RS 485, USB
D500 0331	S331 Display and Data Logger, Panel Version, 2 x SDI & 16 x Modbus/RTU input, Ethernet, RS 485, USB

Analog input

A1672	None
A1662	2 analog inputs 0/4 ... 20 mA, 0 ... 10 V + 2 pulse inputs

Power supply (must choose one option)

A1663	Power supply input 100 ... 240 VAC, 20 VA, with 2 Alarm relays
A1664	Power supply input 18... 30 VDC, 20 W, with 2 Alarm relays

Wall casing

A1673	None, Panel mounting
A1665	Wall mountable casing with 4 cable glands
A1666	Wall mountable casing with 7 cable glands
A1667	Wall mountable casing with 3 cable glands + Ethernet
A1668	Wall mountable casing with 6 cable glands + Ethernet

Hat rail

A1674	None
A1669	Hat rail holder (only in connection with wall mountable casing)

Accessories

Order No. Description

Cables

C219 0055	M12 connector with RS-485 termination resistor, 120 Ω , for Modbus daisy chain termination
A554 3310	M12 RS-485 (Modbus) splitter
A553 0130	USB cable for S330 / S331 (1 cable included in S330 / S331)
A553 0104	Sensor cable 5 m, with M12 connector, open wires, AWG 24 (0.2 mm ²)
A553 0105	Sensor cable 10 m, with M12 connector, open wires, AWG 24 (0.2 mm ²)
A553 0106	Power cable with mains plug, 1.8 m
A553 0120	Ethernet cable 5 m, RJ45 plug at both ends

Converters and gateways (Please contact our customer service for further converter/gateway options)

A554 0011	RS-485 repeater
A554 0331	RS-485 / USB converter

Software

M599 2031	S4M, data acquisition and analyzes software
A1102	Add-on Energy Manager for S4M

Others

D554 0031	8-channel current input module, 0 ... 20 mA, Modbus/RTU
A554 0007	Power supply wall mountable
A554 0009	Power supply for hat rail
A554 3311	Line filter for EMC protection
A554 3313	Connection board for looping 4 ... 20 mA and pulse signals to PLC, mountable in wall casing A1666 or A1668

S320

Display



EASY TO USE
User-friendly design



POWER SUPPLY
Flexible power supply



ALARM
Optional alarm settings



USB INTERFACE
For configuration with S4C software



EASY INSTALLATION
Wall or panel mountable casing



SIGNAL INPUTS
Digital and analog input



Benefits

- ✓ Cost-efficient display unit for live readings on a big display
- ✓ Inputs for sensor connection:
 - 1 input for flow / dew point sensor
 - 1 input for analog sensors
- ✓ 2 relay outputs for alarm with optional alarm on display
- ✓ USB interface for configuration with S4C software
- ✓ Wall or panel mountable casing

Display Solutions for Sensors

The S320 Display provides a cost efficient display solution for industrial applications where information from a single difficult-to-access sensor is required. The display has an input for SUTO flow meters and dew point sensors.

It can display all relevant parameters (flow, dew point, pressure, temperature, power consumption, compressor status etc.) in a compressed air system.

Dimensions

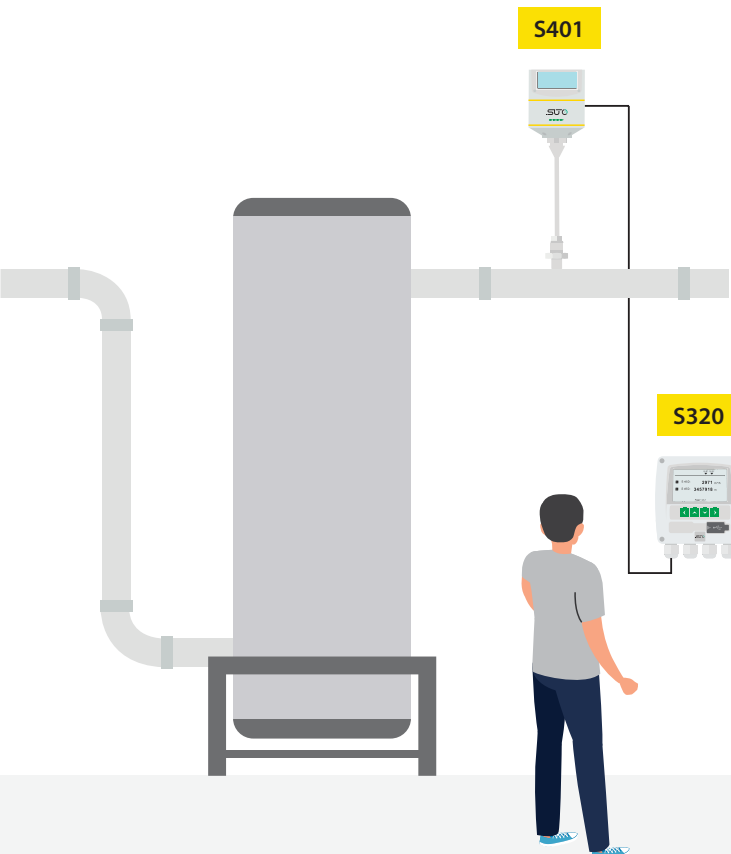
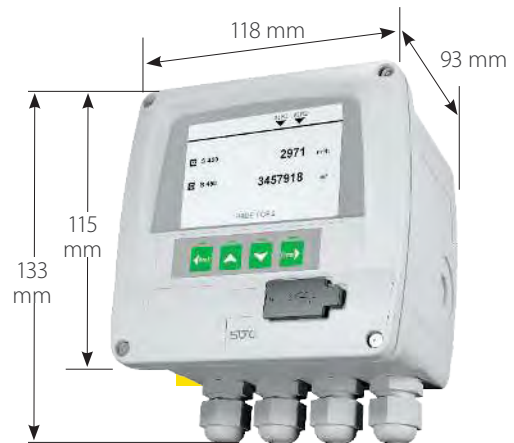

Inputs

- 1 input for SUTO flow/ dew point sensors
- 1 input for analog sensor (0 ... 20 mA, 0 ... 10V)

Outputs

- Communication Interfaces USB port
- Other Signals / Features
- 2 Alarm relay outputs

Technical Data

Signal / Interface & Supply

Input signals

Digital input	1 x SDI for dew point and flow sensors
Analog input	1 x 0 ... 20 mA or 1 x 4 ... 20 mA or
Pulse input	1 x 0 ... 10 V

Output signals

Alarm output	2 relays, 230 VAC, 3 A
--------------	------------------------

Electrical data

	100 ... 240 VAC, 15 VA (option A1640)
Power supply	18 ... 30 VDC, 15 VA (option A1641)
Sensor supply	24 V, 10 W

Data interface

Connection	USB to PC
Operation	Keyboard, 4 keys

General data

Configuration

PC Software	S4C-Display software
-------------	----------------------

Display

Integrated	Graphic display, 220 x 140 pixels with back light
------------	---

Material

Housing	ABS
---------	-----

Miscellaneous

Protection class	IP65
Approvals	CE
Weight	0.52 kg
Housing	Panel, wall mountable
Dimensions	See dimensional drawing
Cable entry diameter	4.5 ... 8 mm

Cable	Supply: AWG 12 ... AWG 24, 0.2 ... 2.5 mm ² ; Signals: AWG 16 ... AWG 28, 0.14 ... 1.5 mm ²
-------	--

Weight	0.52 kg
--------	---------

Operating conditions

Ambient temperature	0 ... +50 °C
Ambient humidity	< 90 %
Storage temperature	-20 ... +70 °C
Transport temperature	-30 ... +70 °C

Ordering

Please use the following table to assist in placing your order with our sales staff.

S320 Display

Order No.	Description
D500 0320	S320 base unit, panel version, 1 input for SUTO sensor, 1 analog input
Power supply	
A1640	Power supply 100 ... 240 VAC, 15 VA, 2 relay outputs
A1641	Power supply 18 ... 30 VDC, 15 VA, 2 relay outputs
Wall casing	
A1649	No wall casing (panel mount)
A1645	Wall mountable casing with 4 cable glands
Accessories	
A553 0104	Sensor cable, 5 m with M 12 connector, open wires, AWG 24 (0.2 mm ²)
A553 0105	Sensor cable, 10 m with M 12 connector, open wires, AWG 24 (0.2 mm ²)
A553 0106	Power cable with mains plug, 1.8 m

S551

Portable Display and Data Logger



AUTO DETECT
SDI or Modbus-based SUTO sensors



VERSATILE CONNECTION
Up to 24 sensors inputs



LTE / 4G MODEM
Access from world wide



TOUCH SCREEN
5" large color LCD



TIGHT PROTECTION
IP65



BACK-UP POWER
Battery as back-up power



Benefits

- ✔ Easy to use and cost-effective data logging solution at the point of use.
- ✔ S4A software for data analysis and remote connection via 4G / LTE Modem
- ✔ Connectable sensors for all required measurement tasks
- ✔ Up to 24 inputs through extension boxes and Modbus
- ✔ Third-party sensors can be easily connected

On site Logging

- Ultra portable and robust design to perform measurement tasks and audits on site
- High resolution 5" color touch screen interface, making the operation as simple as possible.
- Back up battery ensures continuous measurement and prevents data loss during power glitches and cuts.

Plug & Play

- With a few settings, the data logger is ready for operations with virtually unlimited memory size.
- No time consuming configuration and programming is required. Just connect the sensor and start the recording.

Optional Remote Connection

- Integrated USB port for 4G dongle connection outside the casing.
- Can be easily connected to the S4A Software and monitored remotely, no longer dependent on a Wi-Fi connection.



↔
Wireless
Connection

Compressor Efficiency Test

Knowing your Compressor Efficiency is the first step for your energy saving requirements

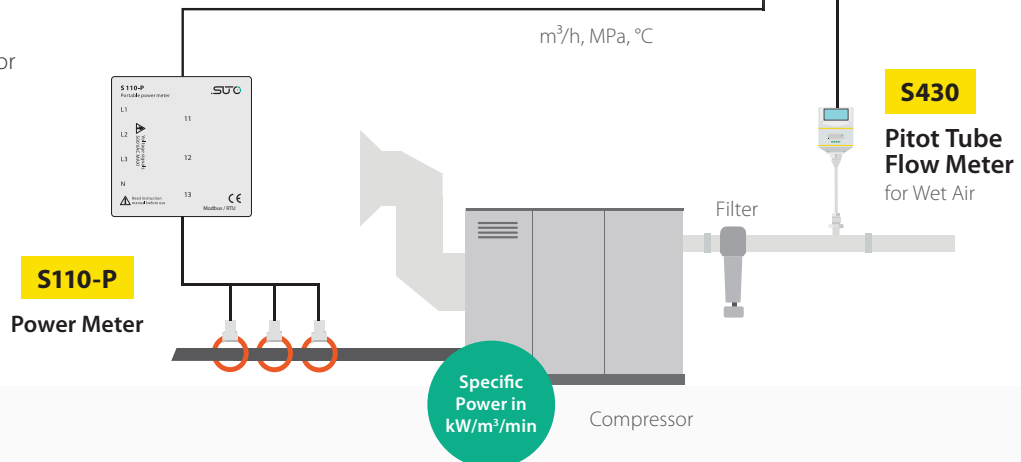

Applications



The S551 Portable Display and Data Logger is the perfect tool for compressed air service engineers as well as compressed air experts.

Due to its compact design and the integrated battery, on-site measurements are carried out most efficient user friendly. From simple dew point spot check up to identifying insufficient compressor systems, the S551 is the tool to make these measurements.

Remote Data Analysis

The S551 is capable of sending measurement data and status information to a remote server through the Internet. This allows users to monitor the system remotely. The illustration below shows the principle setup.

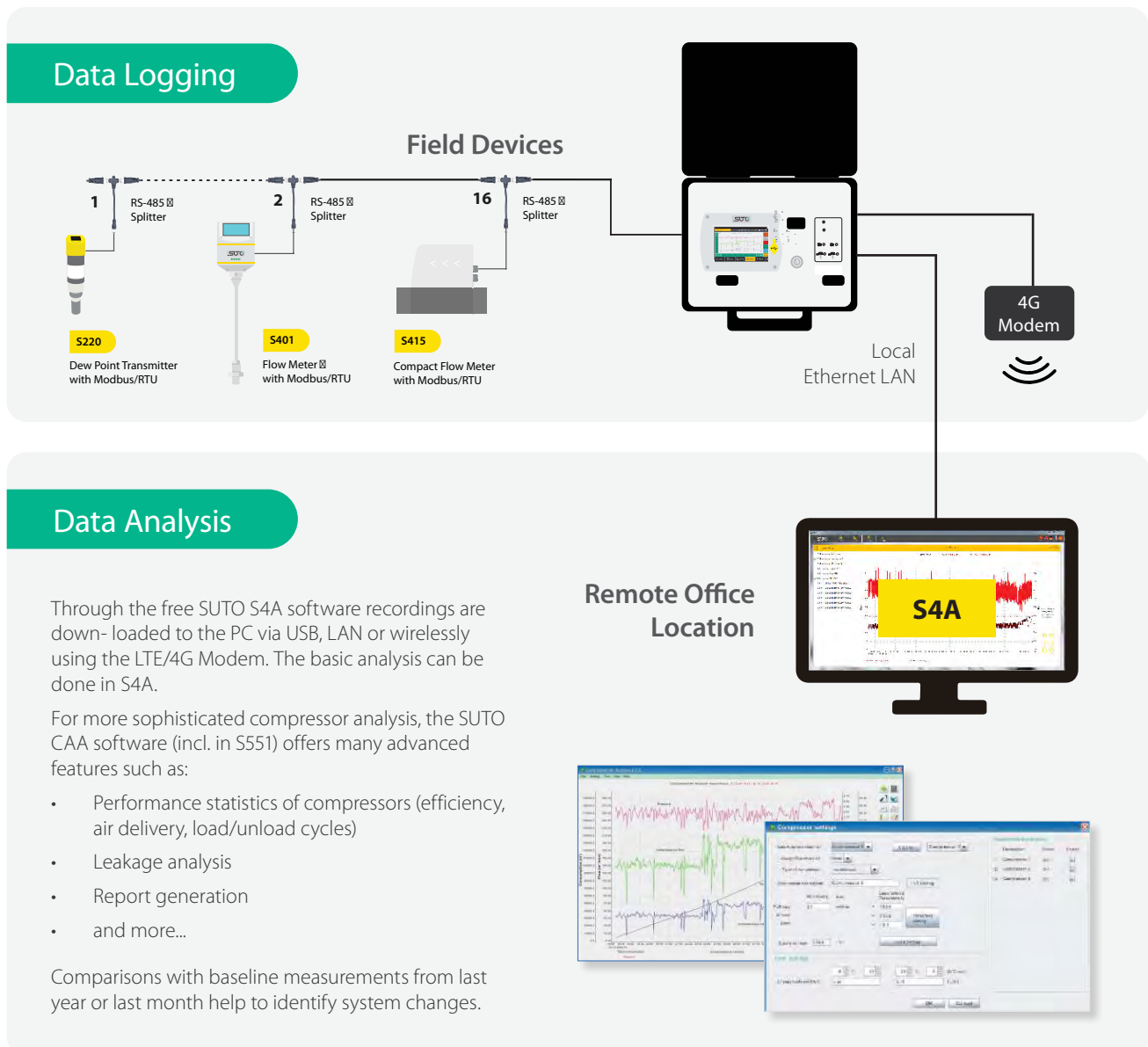

Versatile Connections and Sensor Inputs

- Connectable sensors for all required measurement tasks (air flow, air consumption, power consumption, pressure, temperature and many more)
- Up to 24 inputs through extension boxes and Modbus
- Third-party sensors can be easily connected



Industrial quick connectors allow a plug & play setup and ensure a reliable sensor connection.



Industrial Ethernet Port for LAN connections



User Friendly Interface

The S551 comes with a high resolution 5" color touch screen interface making the operation as simple as possible.

SUTO intelligent sensors are detected automatically on power-up. With a few settings the data logger is ready for operations with virtually unlimited memory size.



Sensor Data Overview

Up to 4 sensors can be viewed on one page and through page scrolling further sensors can be displayed.

This makes it easy to monitor different sensors at the same time.



Graphic Charts for Quick Analysis

Select which channels you want to view or analyze and the built in graphic analyzer will help you identify problems immediately.

For detailed analysis we recommend using SUTO software S4A, CAA or S4M.

Technical Data

Signal / Interface & Supply

Data logger

Storage	4 GB, up to 100 million values
Sampling rate	The minimum time interval is 1 second

Digital input

Interface	2 x SDI connectors, 2 x Modbus/RTU connectors
Update rate	Value updated every 1 sec
No. of connectable Sensors	2 x SDI sensors 16 x Modbus/RTU sensor

Analog input

Signal	Analog (0 ... 20 mA, 4 ... 20 mA, 0 ... 1 V, 0 ... 10 V), Pulse
Burden	max. 250 Ohm
Update rate	Value updated every 1 sec

Fieldbus output

Protocol	Modbus/RTU, Modbus/TCP
Update rate	Value updated every 1 sec

Other outputs

Communication Interface	4G/LTE (optional)
Purpose	View the online measurement values, read out the logging files remotely through S4A software and USB 4G dongle

Supply

Main power supply	100 ... 240 VAC, 50/60 Hz, 1.4 A
-------------------	----------------------------------

Data interface

Connection	USB micro, LAN (Ethernet)
Purpose	Read logger files & screenshots, show live data
Integrated web server	Remote monitoring (LAN)

General data

Configuration

PC Software	S4C-Display (via USB or LAN)
-------------	------------------------------

Display

Integrated touch screen	5" high resolution graphic display, 800 x 480 pixels with touch interface
-------------------------	---

Material

Housing	PC + ABS
---------	----------

Miscellaneous

Electrical connection	2 x M12 (5 pole) for SDI; 2 x Optional M12 (5 pole) for analog and pulse; 2 x M12 (5 pole) for Modbus; 1 x RJ45 Ethernet
-----------------------	--

Protection class	IP65 (only if the suitcase lid is closed and locked)
------------------	--

Weight	4 kg
--------	------

Operating conditions

Operating temperature	0 ... +50 °C
-----------------------	--------------

Storage humidity	< 90 %
------------------	--------

Storage temperature	-20 ... 50 °C
---------------------	---------------

Transport temperature	-20 ... 50 °C
-----------------------	---------------

Ordering

Please use the following tables to assist in placing your order with our sales staff.



Data logger

P560 5100	S551-P4, Portable Display and Data Logger, 4 digital input channels, power cord, USB cable, S4A software, CAA software
P560 5101	S551-P6, Portable Display and Data Logger, 4 digital input channels and 2 analog, power cord, USB cable, S4A software, CAA software
A1670	USB 4G dongle for S551/S600, including S4A software

Flow sensors

S601 0401	S401, 300 mm Shaft, insertion type thermal mass flow meter, max measuring range, DN15 ... DN300, Modbus/RTU, including 5 m cable with connector to S551
S601 0430	S430, 220 mm Shaft, insertion type Pitot tube flow meter for wet air, DN25 ... DN250, Modbus/RTU, including 5 m cable with connector to S551

Dew point sensor

S601 0215	S215 Dew Point Transmitter, -20 ... +50 °C Td, Measuring chamber with quick coupling, 5 m cable with connector to S551
S601 0211	S211 Dew Point Transmitter, -60 ... +20 °C Td, Measuring chamber with quick coupling, 5 m cable with connector to S551
S601 0220	S220 Dew Point Transmitter, -100 ... +20 °C Td, Measuring chamber with quick coupling, 5 m cable with connector to S551

Pressure sensors

S694 1886	Pressure Transmitter, 0 ... 1.6 MPa(g), 4 ... 20 mA including a 5 m cable with connector to S551 (works only on S551-P6)
S694 0356	Pressure Transmitter, 0 ... 4.0 MPa(g), 4 ... 20 mA including a 5 m cable with connector to S551 (works only on S551-P6)
S694 1887	Pressure Transmitter, 0 ... 1.6 MPa(g), Modbus/RTU including a 5 m cable with connector to S551 (works on S551-P4 & P6)
S694 1888	Pressure Transmitter, 0 ... 4.0 MPa(g), Modbus/RTU including a 5 m cable with connector to S551 (works on S551-P4 & P6)

Amp sensor

S554 0156	Electrical Current Transmitter, 1000A, 100 mm diameter, including connector to S551
S554 0157	Electrical Current Transmitter, 3000A, 150 mm diameter, including connector to S551

Temperature sensor

S693 0005	Temperature Transmitter, -50 ... +200 °C, 4 ... 20 mA loop powered, 6 x 150 mm sensor tube, 5 m cable with connector
A554 6003	Compression fitting, 6 mm, G ½" thread, 0.6 MPa
A554 6004	Compression fitting, 6 mm, G ½" thread, 1.6 MPa

Power meter (for 3 phase and single phase measurement)

P554 0134	Portable Power and Energy Meter S110-P, Modbus/RTU, including 4 test leads, 4 test clips, 5 m cable with connector to S551
S554 0160	Electrical Current Transmitter for S110-P, 1000 A, 100 mm diameter, 1.8 m cable, connector to S110-P
S554 0161	Electrical Current Transmitter for S110-P, 3000 A, 150 mm diameter, 1.8 m cable, connector to S110-P
S554 0162	Electrical Current Transmitter for S110-P, 100 A, 160 mm diameter, 1.8 m cable, connector to S110-P

Note: For 3 phases power supply 3 Rogowski coils are needed.

Ordering

Please use the following tables to assist in placing your order with our sales staff.



Other sensors / extensions

P554 0080 8 channel analog input extension, connectable to S551, including 5 m cable with connector, 2-wire sensors support only
 Note: we offer other two models which supports 3-wire inputs and combination of 2-wire and 3-wire. Please contact the sales.

A554 3314 Portable Modbus splitter box, with M12 connector

Accessories

A553 0103 Extension cable, 5 m, male-female connectors

A553 0110 Open wires cable, 5 m cable with connector

A553 0111 Sensor cable, M12, 5 m with connector to S551

A554 0035 Transport case S551 for sensors and cables, L560 x W450 x H160 mm (internal compartment can be arranged according to your individual sensor requirements)

A554 0036 Transport case, customized for 1 x S110-P, 3 Rogowski coils, 4 x test leads, 4 x test clips, 1 x S430

* Please contact us for further accessories and details.

S4M SaaS

Smart Compressed Air System Monitoring Software



Coming Soon!

Next Level of Compressed Air System (CAS) Monitoring Software Service



PROCESS VALUE VISUALIZATION



CUSTOMER MANAGEMENT



LIVE VIEW OF PROCESS DATA



POWERFUL REPORTING MODULE



EXTENSIVE DATA ANALYSIS



MONITORING & OPTIMIZATION



ALARMS & NOTIFICATIONS



PERSONALIZED INTERFACE



Benefits

- ✔ Ensuring system performance and reliability with remote monitoring and alarm management
- ✔ Energy saving and CO₂ emission reduction by detecting system efficiency potentials
- ✔ Live monitoring of air production, usage and historical records for detailed system overview
- ✔ Minimization of initial CapEx by fast development and launch
- ✔ Easy to use plug & play solution for fast implementation of gateways and devices
- ✔ Auto-generate customized CAS reports for audits

Manage and ensure your whole compressed air system — reduce downtime and costs

S4M SaaS has been developed from the ground up with the focus on Compressed Air System Monitoring and Optimization.

The software allows end users to get their CAS under control, ensure their process safety and the reliability of their compressed air system. At the same time, the software offers compressed air service companies to have their client's system up and running, by simply checking the end client's CAS from anywhere at any time.

S4M SaaS not only gathers the measurement data from in-field devices, but with its built-in features, S4M SaaS actually is taking care of the complete system, from asset management, alarms, calibration & maintenance to consumption and energy reporting, all in one solution.

With S4M SaaS end users as well as service companies finally getting compressed air systems under control.

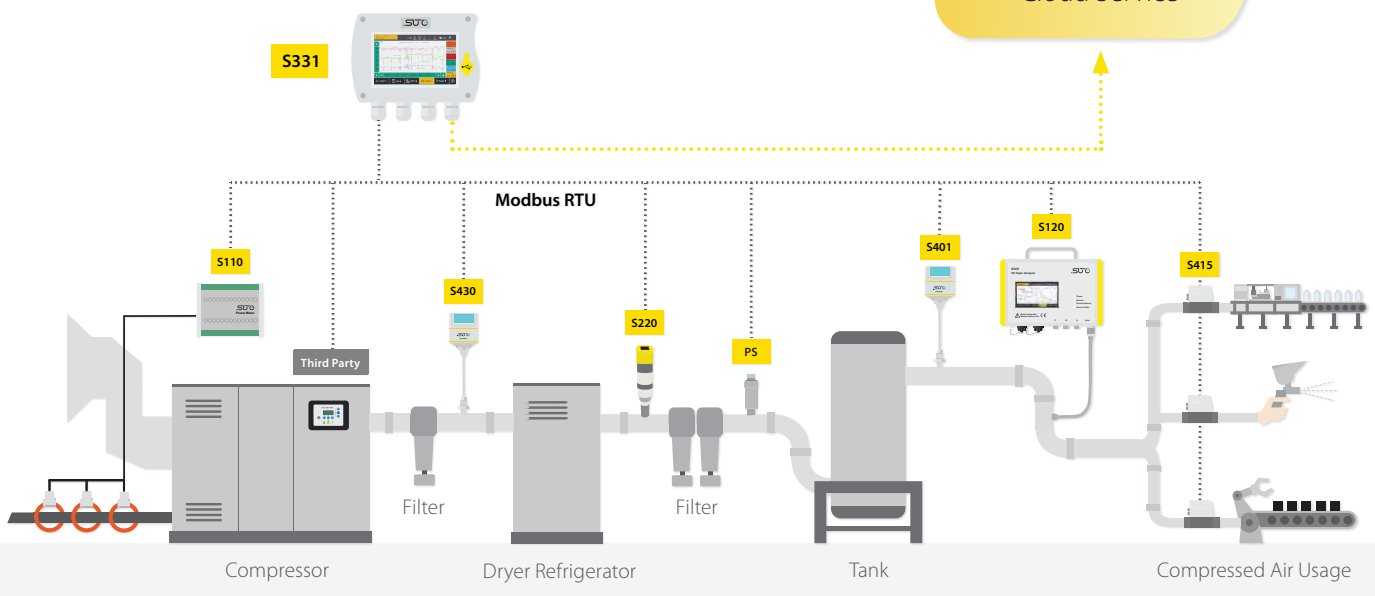
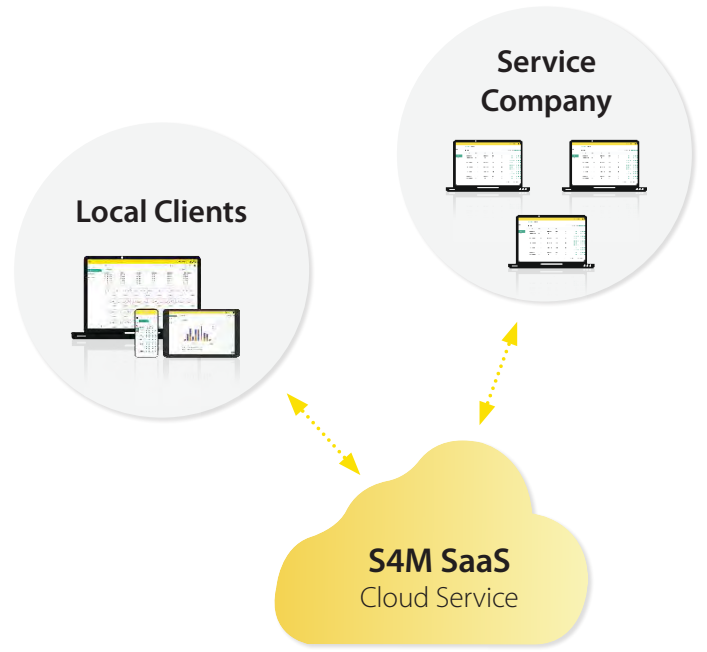

Customizable Dashboard

- Dashboard for system overview and monitoring
- Real-Time data and graphical analysis from the dashboard
- Dashboard fully customizable to users needs with dashboard widgets
- Quick analyzes directly from the dashboard
- Alarm and status indication



Powerful Data Analysis

- Analyze all channels and parameters within a single module
- Compare historical data with actual data
- Benchmark your system and define KPIs
- Easily find weak spots and optimization potentials at a single glance



Live View of Process Data

- Real-time measurement data of multiple factories and locations
- Live view of all measurement channels
- Drag & drop marker to place measurement data
- Upload system / factory plan to place your measurement device
- Alarm indications and notifications

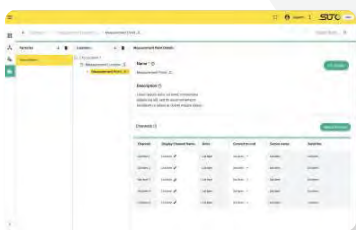
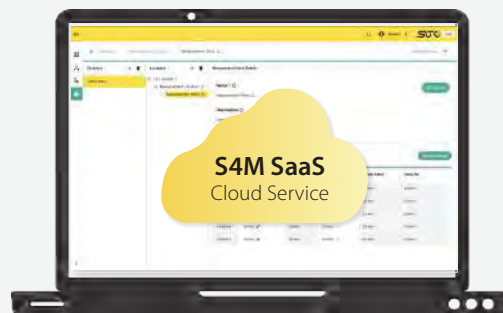
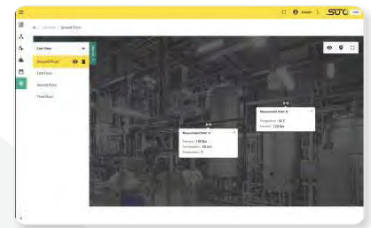

Location Management

- Logical and easy to understand complex structures of field devices
- Define factories, measurement locations and measuring Points
- Assign factories to different customers
- Convert Measurement units and set up virtual channels



Asset Management

- Track all components of the CAS in a single solution
- Create maintenance and calibration schedules and get notified in time
- Set up regular tasks on your CAS
- Track sensitive equipment by serial number & get notifications

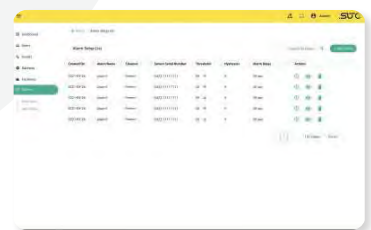

Alarm Management

- System wide alarm management with full alarm history
- Active alarms list with mute functions during maintenance or repairs
- Assign alarms to any channel within the system
- Multiple on-screen alarm notifications as well as email and push notifications on smartphones

Powerful User Access Right Management

- Easy to set up check-box based access-rights management
- Most flexibel user rights: Read-only accounts, default user accounts, multiple administrators
- Access rights management for each module
- Create private dashboards, alarms, analytics to be seen only by the specific user
- Set up multiple accounts and distribute their access rights

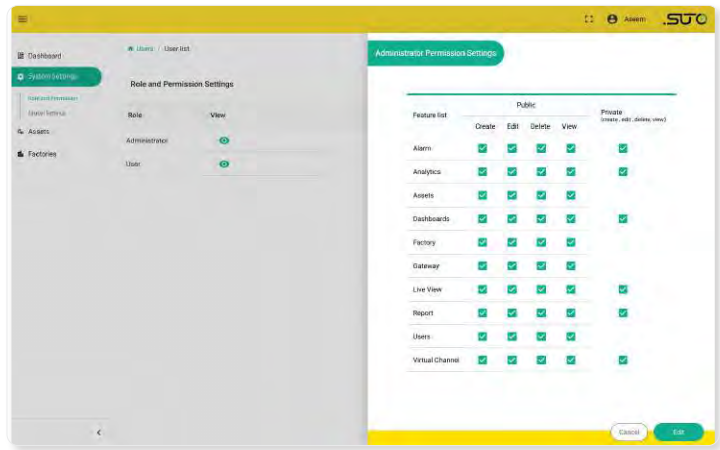

Create Powerful Reports

- Create powerful reports with a single Click
- Regular reporting with suggestions
- Energy cost and consumption reports
- Get reports sent automatically daily, monthly, weekly, quarterly or annually by Email
- Customize report colors and logos
- No more manual reporting needed so user can focus on more important things
- Set up management users to receive automatic financial reporting



Why Data Is So Important?

Compressed air is one of the most expensive energy forms and widely used in almost any application and process. Almost 50 % of the compressed air and gases that is generated is not used efficiently.

Profound real-time system data will help to unleash optimization potentials:

- ✓ System Performance and Reliability
- ✓ Energy Efficiency and Cost Reduction
- ✓ Product Quality and Safety
- ✓ ISO Purity Requirements
- ✓ Carbon Footprint Reduction
- ✓ Less Maintenance and System Failures

Data Analysis



S4M SaaS
Cloud Service

Data Logging



S331 Data Logger and Display

Plug & Play gateway and central interface between field devices and S4M SaaS monitoring solution.

Connect up to 16 Modbus/RTU sensors, 2 analog sensors and 2 SDI sensors to a single data logger

Field Devices



SUTO SDI and Modbus/RTU sensors as well as analog sensors can be connected to the S4M SaaS within minutes. To connect the Modbus/RTU sensors properly on an RS 485 bus system, it's recommended to daisy-chain the sensors to one of the inputs. For this purpose, SUTO offers a RS 485 splitter to simplify the connection.

Through this method, users can add up to 16 sensors to the S331 master input. This allows to monitor whole plants with the S4M SaaS using a single data logger.

By relying on the industry standard protocol Modbus/RTU, third-party sensors and device can be easily integrated into the S4M SaaS through the S331 Data Logger Gateway. Field devices can be easily set up using the configuration software, allowing to add a third-party sensor within seconds.

Of course, all connected sensor data can be logged to the internal memory, used for virtual channel calculations. At the same time, real-time values are sent to S4M SaaS and safely stored.



End User License

The End User License is made for the Compressed Air System Operators and Facility Management.

This License grants access to the own compressed air system throughout the whole factory and among multiple locations. The system can be accessed by multiple users within the same organization.

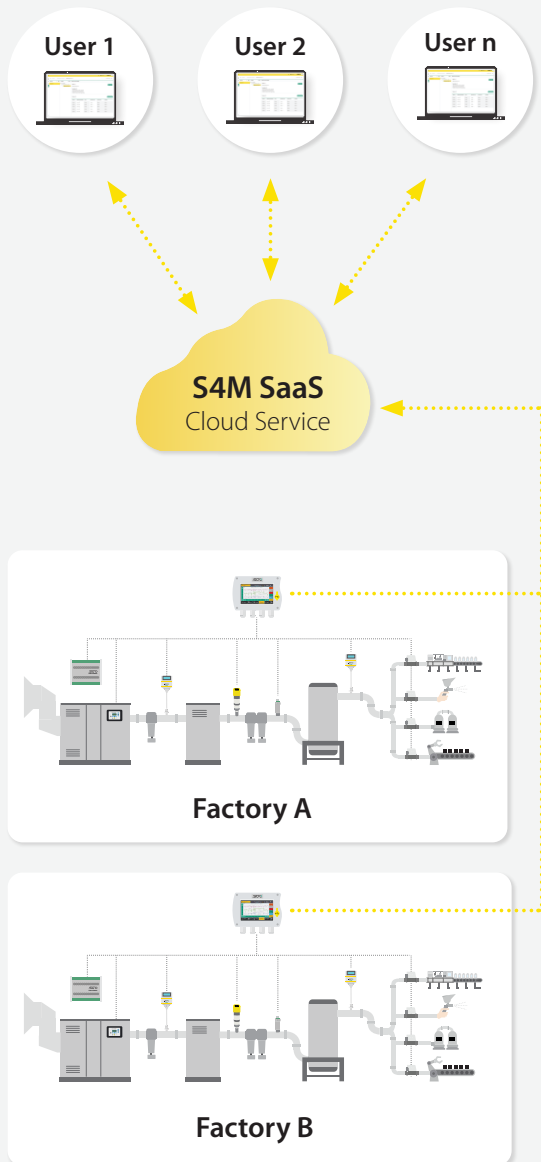

Service Provider License

The Service Provider License is made for Compressed Air Service Companies, which are offering their service for clients. Service Companies are enabled to monitor their clients compressed air systems, all over the world.

Each client is separated and the Service provider is enabled to grant the end clients access to their own system.

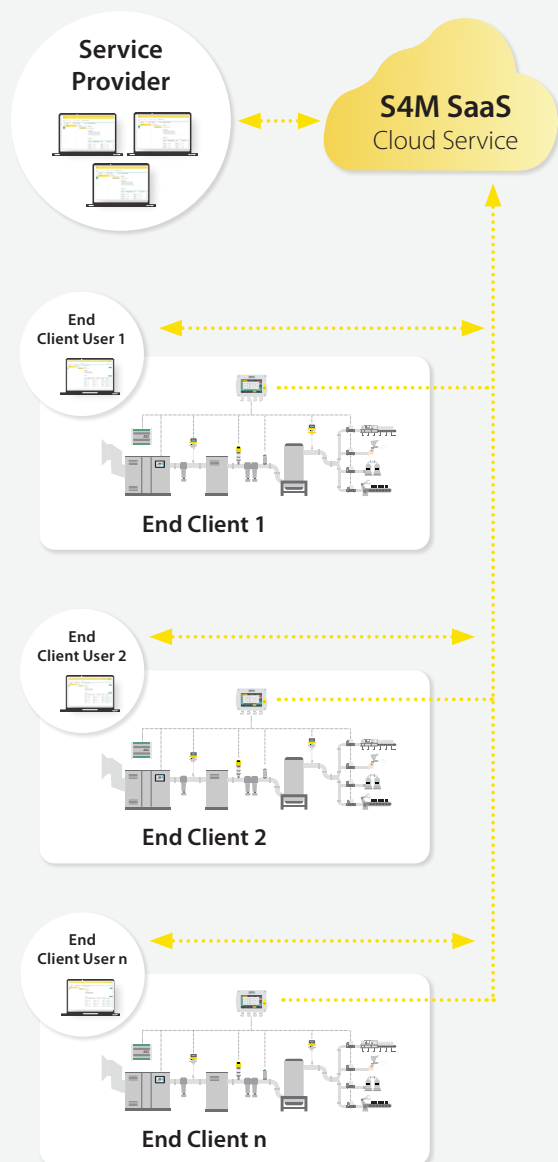

License Packs

	Trial	Starter	Essentials	Team	Enterprise
License Type	End User	End User	End User	Service Provider	Service Provider
User	1	1	5	10	100
Number of Channels	5	20	50	100	500
Add Additional Channels					
Add Additional Users					
License	Free (For 90 Days)	Annual Subscription	Annual Subscription	Annual Subscription	Annual Subscription

Contact Us

Please contact our sales to assist you finding the license type which suits your requirements.

<p>EUROPE</p> <p> +49 (0) 7634 50488-00</p> <p> sales@suto-itec.com</p>	<p>CHINA</p> <p> +86 (0) 755 8619 3164</p> <p> sales.cn@suto-itec.com</p>
<p>ASIA/PACIFIC</p> <p> +852 2328 9782</p> <p> sales.asia@suto-itec.com</p>	<p>NORTH AMERICA</p> <p> +1 (616) 800-7886</p> <p> sales.us@suto-itec.com</p>

Explanations

User

A user is a login who can access the system and full functionalities. User access rights can be controlled by the administrator and set individually.

One user is always the administrator with all access rights.

Channels

Each Measurement value is represented as a channel.

Example: 1 Flow Meter (Flow and Consumption = 2 channels) + 1 Dew Point Meter (Dew point, Temperature and Humidity = 3 channels) results in a total of 5 channels.

Created virtual channels are represented as a channel and part of the total channels available



www.suto-itec.com

S4A

Data Analysis Software



GRAPHIC ANALYSIS
Powerful graphic analysis



ONLINE READING
Real time data reading with USB or Ethernet connection



FREE TO USE
No payment or subscription needed



ANALYSIS ON EXPORTED FILES
Export data to the .XLSX and .CSV file



READOUT OF SCREENSHOTS
Read screenshots from SUTO S331



REMOTE CONNECTION
Read out field devices via Internet connections

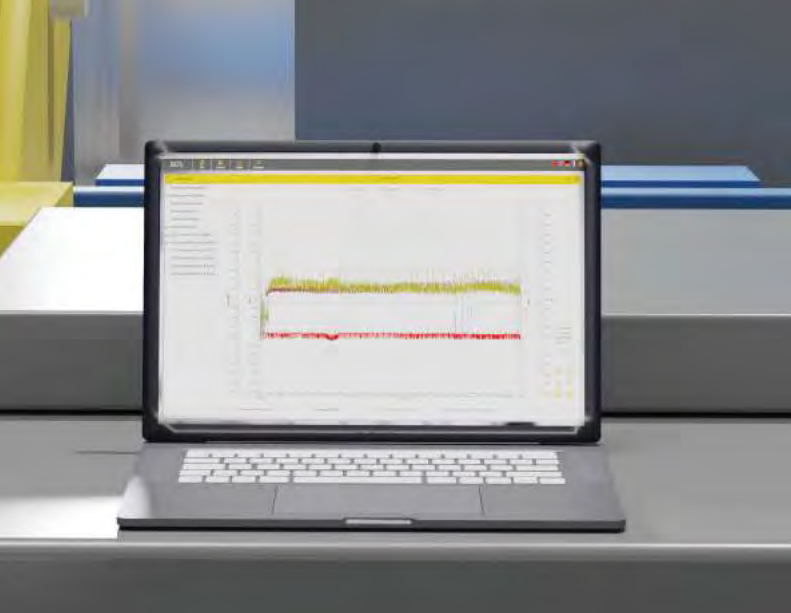

Benefits

- ✔ Free software with quick analysis through powerful graphs and exported tables
- ✔ On-site real time analysis through online data reading
- ✔ Remote access of SUTO displays and Loggers that are equipped with LTE/4G modem
- ✔ Easy installation with installation wizard
- ✔ Multiple languages available

Data Analysis with S4A

S4A is a stand alone free software used to analyze measurement data recorded by SUTO data loggers. Local stored logger files from any SUTO device with logging function can be opened, analyzed and exported.

- Real-time online readings of a SUTO device via a USB , Ethernet or wireless LTE/4G connection.
- Powerful graphic tools allowing basic and in-depth analyzes of the data and prepare reports.
- Easy is to set up interface for hassle-free use. No complicated setup menus or configurations. Simply connect SUTO data loggers and read logging files with a single click.
- Integrated export function offers data exchange in .xlsx and .csv format.
- Software recordings are downloaded to the PC via USB, LAN or wirelessly using the LTE/4G Modem.
- The wireless connection offers full functionality as if the devices would be connected via USB. This makes it most flexible and versatile.

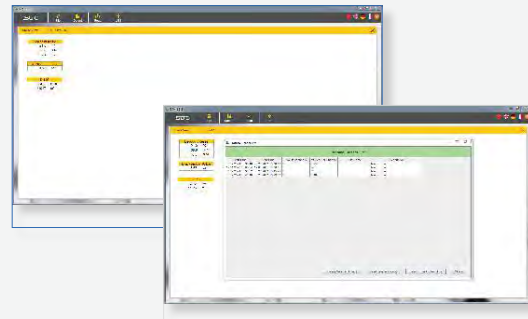

Remote Office Location

S4A



Local Ethernet LAN

Data Logging

S331
Data Logger

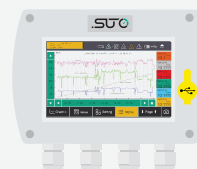

4G
Modem

Field Devices

Modbus/RTU
Sensors

Analog
Sensors

Download

The S4A Software is offered for free and the latest version can be downloaded from the SUTO homepage, no registration or subscription needed.

www.suto-itec.com

S4C

Smartphone Apps

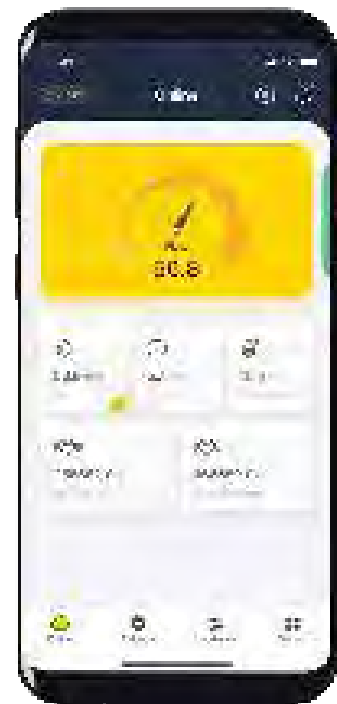
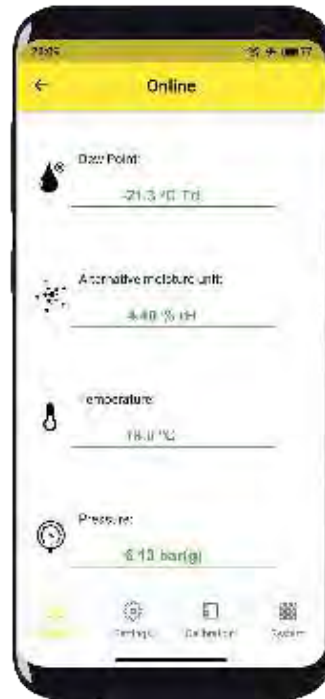

FREE SMARTPHONE APPS
For remote Configuration



ONLINE READING
Live measurement data



EASY TO USE
User-friendly design



WIRELESS CONNECTION
Connection to devices in hard-to-reach places



Benefits

- ✔ Wireless connection to SUTO iTEC field devices
- ✔ On-site configuration without the need of PC; everything runs from your smartphone
- ✔ Third-party access protection by QR code protected settings
- ✔ Real-time data readings and sensor settings
- ✔ User friendly design with intuitive workflows
- ✔ No registration or subscription needed
- ✔ Online Configuration and guided setup as well as customer calibration features

S4C-FS App for SUTO Flow and Consumption Meters

- Connect wirelessly to SUTO flow and consumption sensors
- Download for Android® and iOS® smartphones
- Live data in the palm of your hands
- On-site configuration and settings
- Fast commissioning of field devices
- User calibrations
- Data logger settings and operations

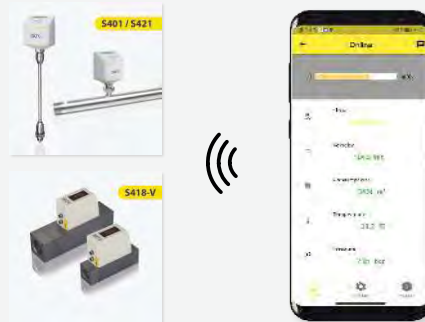

S4C-DP App for SUTO Dew Point Meters

- Connect wirelessly* to SUTO dew point sensors
 - Download for Android® and iOS® smartphones
 - Live sensor readings on your smartphone
 - On-site configuration and settings
 - Fast commissioning of field devices
 - User calibrations and adjustments
- *needs the optional Wireless-DP-Adapter

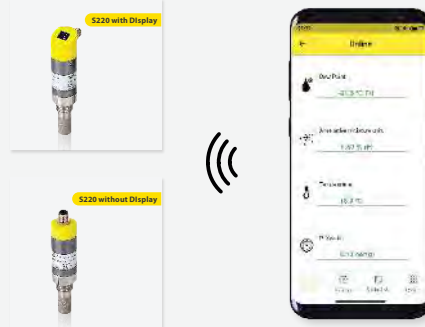

S4C-US App for SUTO Ultrasonic Meters for Liquids

- Connect wirelessly to SUTO ultrasonic flow meters
- Download for Android® and iOS® smartphones
- Guided setup and installation
- Adjust installation parameters and get signal quality feedback
- Actual Flow and Total consumption as well as historical data
- On-site configuration and settings
- Logger data readout and logger file sharing
- User calibrations

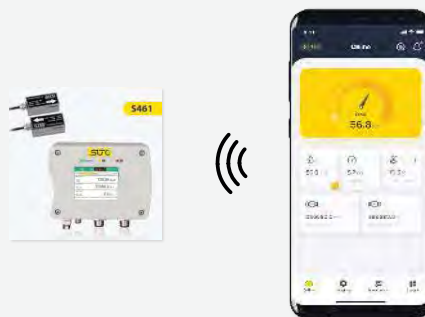

S120

Oil Vapor Monitor



Opt. 1 Without Display

Opt. 2 With Display



ACCURATE RESULTS
Latest PID sensor technology



TOUCH SCREEN
For easy operation



EASY INSTALLATION
Plug and Play Solution



COMPACT DESIGN
Fits into your application



DATA LOGGER
Integrated as option



DEW POINT SENSOR
Option:
-100 ... +20 °C Td

Benefits

- ✔ Plug & Play setup with quick connections. Can be used in portable and stationary applications.
- ✔ Oil vapor measurement in a range of 0.001 to 5.000 mg/m³
- ✔ Various output signals to connect the unit to building management systems
- ✔ PID sensor technology for fast response time and Online monitoring
- ✔ Optional with integrated 5" touch screen display with data logger function
- ✔ Optional with integrated dew point measurement
- ✔ LED indications for status and alarms

Simple Installation – Outstanding Performance

The S120 is designed to offer users an efficient way of measuring residual oil contents in a compressed air system.

The integrated automatic calibration compensates temperature and humidity drifts in the supplied air, resulting in most accurate, reliable and long term stable measurement results.

The simple plug & play installation, as well as its outstanding performance, makes the S120 the ideal choice when oil vapor needs to be measured and monitored.

Applications

Oil free compressed air is not an easy task to be achieved. Monitoring is a must in many industries and applications to avoid contamination in products and risks for health of humans.

- Medical air
- Pharmaceuticals
- Breathable air for rescue workers and divers
- Food and beverage
- Semiconductor fabs
- Conveyance of hygroscopic food
- High tech processes

Optional Integrated Dew Point Sensor

To ensure compressed air quality and purity, dew point measurement is an essential key parameter. Therefore, we offer an optional integrated Dew Point Sensor, -100 ... +20 °C Td, to measure both parameters in one compact device with an excellent price performance ratio.

Output Signals

- 4 ... 20 mA analog output
- Modbus/RTU and Modbus/TCP (TCP only with Display version)
- Alarm Relay

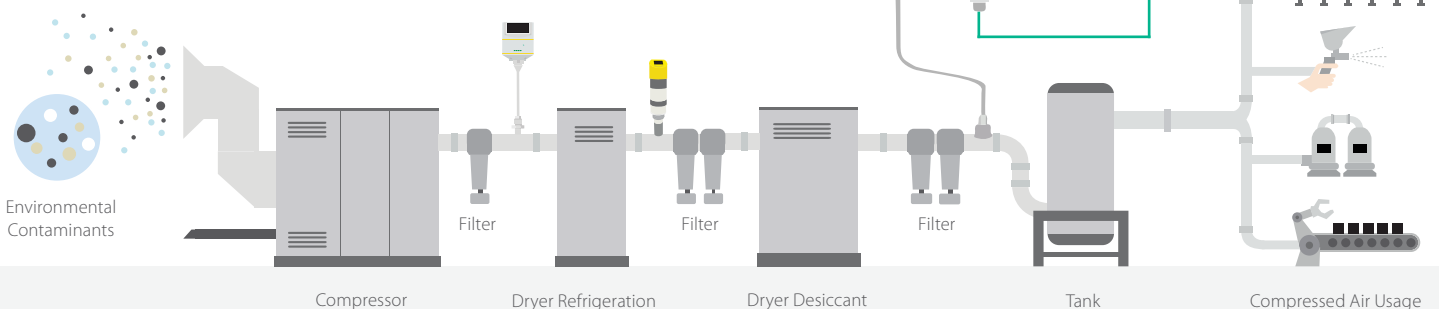

Technical Data

Measurement

Oil Vapor

Measuring range	0.001 ... 5.000 mg/m ³ (Based on 1000 hPa(a), 20 °C, 0 % relative humidity)
Accuracy	5 % of reading ± 0.003 mg/m ³
Resolution	0.001 mg/m ³
Selectable units	mg/m ³ / ppm
Sensor principle	Photo ionization detector

Pressure

Measuring range	0 ... 16 bar(g)
Accuracy	0.5 % FS
Resolution	0.01 bar(g) / 0.001 MPa / 0.1 psi
Selectable units	bar(g) (default), MPa and psi (on request)
Sensor principle	Piezo resistive pressure sensor

Dew Point (optional)

Measuring range	-100 ... +20 °C Td
Accuracy	±1 °C Td (0 ... 20 °C Td) ±2 °C Td (-70 ... 0 °C Td) ±3 °C Td (-100 ... -60 °C Td)
Resolution	0.1 °C Td
Selectable units	°C Td / °F Td
Sensor principle	QCM + Polymer

Temperature

Measuring range	0 ... 50 °C
Accuracy	0.5 °C
Resolution	0.1 °C
Selectable units	°C / °F
Sensor principle	NTC

Signal / Interface & Supply

Outputs / Interface

Analogue output	4 ... 20 mA, isolated
Alarm output	Relay, NO, 40 VDC, 0.2A
Digital interface	Modbus/RTU (RS485) Modbus/TCP (Ethernet) & USB (only available for display version)
Display (optional)	5" color touch screen with a data logger of 30 million measurement values

Supply

Power supply	24 VDC ± 5 %, 10 W
--------------	--------------------

- Power
 - Alarm
 - Service Sensor
 - Service Filter
- LEDs indicate if pre-set alarms are reached, or if filters and sensors need to be serviced. The service indications start blinking 4 weeks before expiring and turn on permanently when a service is immediately required.

General Data

Measuring medium	Compressed air, N ₂ , CO ₂ (for other gases please contact us)
Sample flow rate	< 2 l/min, measuring gas is released to ambient
Sample rate	1/sec
Gas / Operating temperature	-20 ... +50 °C
Transport temperature	-30 ... +70 °C
Operating pressure	3 ... 15 bar(g) 0.5 ... 2 bar(g) (optional) 0.60 ... 1.07 bar(a) (ambient version only)
Gas humidity	< 40 % rel. humidity, no condensation
Gas connection	6 mm quick connect
UV lamp lifetime	6,000 working hours or 1 year, whichever comes first
Electrical connection	M12, USB, RJ45
Settings	Various sensor settings can be performed through SUTO display units or through the related service software
Housing material	PC, Al alloy
Protection class	IP65
Dimensions	271 x 231 x 91 mm
Weight	2.4 kg
Approval	CE



Ordering

Please use the following table to assist in placing your order with our sales staff.

S120 Oil Vapor Monitor

Order No.	Description
S604 1201	S120, Oil Vapor Monitor, 0.001 ... 5.000 mg/m ³ , 4 ... 20 mA output, RS-485, alarm output, supply 24 VDC, incl. power supply
S604 1202	S120-P, Portable Oil Vapor Monitor, 0.001 ... 5.000 mg/m ³ , 4 ... 20 mA output, RS-485, alarm output, connectable to S551, transport case, incl. power supply
S604 1203	S120, Oil Vapor Monitor, 5" touch screen, 0.001 ... 5.000 mg/m ³ , 4 ... 20 mA output, RS-485, alarm output, supply 24 VDC, incl. power supply
P604 1205	S120-P, Portable Oil Vapor Monitor, 5" touch screen, 0.001 ... 5.000 mg/m ³ , 4 ... 20 mA output, RS-485, alarm output, 24 VDC supply, incl. transport case, power supply
P604 1215	S120-Ambient Portable Oil Vapor Monitor for ambient air, 5" touch screen with data logger, 0.001 ... 5.000 mg/m ³ , 4 ... 20 mA, RS-485 (Modbus RTU), Ethernet (Modbus TCP), alarm output, integrated pump, supply voltage 24V DC, incl. power supply and transport case.
A1250	Option: Integrated dew point sensor, -100 ... +20 °C Td (only for S604 1203 and P604 1205)
Accessories	
A554 1203	Oil vapor zero filter, 1.5 MPa max, with quick connectors at both ends
A554 1207	Replacement kit for zero filter oil vapor analyzer
A554 0120	Option, Transport case S120/130
Calibration	
R200 0120	S120 General service and re-calibration (for all models without Dew Point Sensor option A1250): - General inspection of the unit - Replacement of tubes and fittings - Cleaning of lamp and sensor - Assembly and test of unit - Calibration of oil sensor - Calibration Certificate
R200 0121	S120 General service and re-calibration with dew point sensor option (for S604 1203 and P604 1205 with Dew Point Sensor Option A1250): - General inspection of the unit - Replacement of tubes and fittings - Cleaning of lamp and sensor - Assembly and test of unit - Calibration of oil sensor - Calibration of dew point sensor - Calibration Certificate

S130 / S132

Laser Particle Counter



ECO (0.3 < d ≤ 5.0 μm) **S130**



S132 PRO (0.1 < d ≤ 5.0 μm)



PARTICLE MEASUREMENT
According to ISO-8573 Standard



EASY INSTALLATION
Plug and Play Solution



PRO VERSION S132
Smallest channel 0.1 < d ≤ 0.5 μm



ECO VERSION S130
Smallest channel 0.3 < d ≤ 0.5 μm



Benefits

- ✓ Accurate compressed air quality measurements and monitoring with particle size ranges: 0.1 < d ≤ 0.5 μm / 0.5 < d ≤ 1.0 μm / 1.0 < d ≤ 5.0 μm / d > 5.0 μm
- ✓ Classify the compressed air systems according to ISO 8573-1 while being in compliance with the ISO 8573-4
- ✓ Easy connection to compressed air system through a 6 mm hose with quick connectors
- ✓ Integrated pressure diffuser suitable for inlet pressure ranges of 3 ... 15 bar(g)
- ✓ Optional 5" touch screen integrated for live data readings and data logging functions
- ✓ Designed to be used in stationary monitoring solutions, as well as in portable audit measurements

Reliable particulates counts in compressed air systems

The SUTO S130 / S132 Laser Particle Counters are optimized for 24/7 compressed air quality monitoring. Unlike its competition, the SUTO laser particle counters are coming with integrated pressure diffusers to reduce the line pressure inside the instrument. Users are enabled to use the laser particle counters directly at the compressed air system, without installing pressure reducers and therefore being in compliance with the ISO 8573-4 standard.

The measurement values are displayed in counts per volume (cn/m³), but can also display alternative volume units like cubic-feet or liter.

The integrated display offers live readings for all channels, signal output settings as well as an integrated data logger, to store the measurement data on the device.

Applications

Particle free compressed air is not an easy task to be achieved. Monitoring is a must in many industries and applications to avoid contamination in products and health risks for humans.

- Medical air
- Pharmaceuticals
- Breathable air for rescue workers and divers
- Food and beverage
- Semiconductor fabs
- Conveyance of hygroscopic food
- High tech processes

S130/S132

Portable and stationary Solution



Output Signals

- 4 ... 20 mA analog output
- Modbus/RTU and Modbus/TCP (TCP only with Display version)
- Alarm Relay

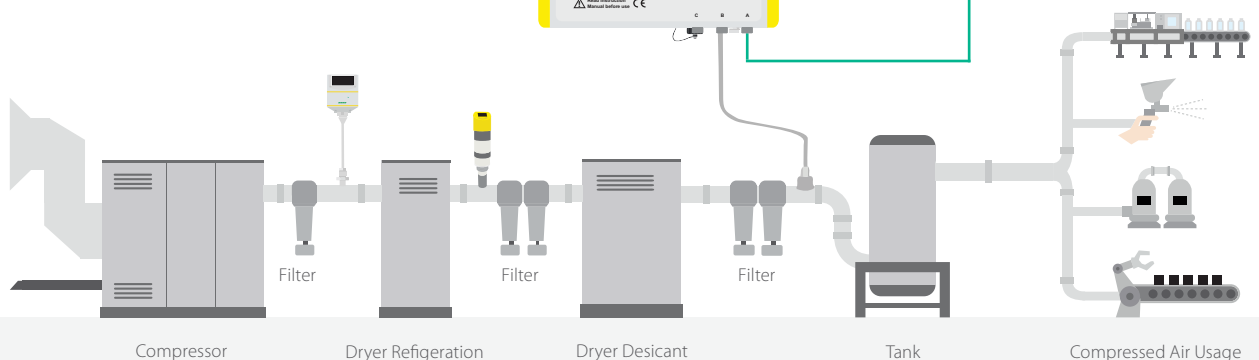

Compressor

Dryer Refrigeration

Dryer Desiccant

Tank

Compressed Air Usage



Particulates in Paint Shops

In a modern paint shop, the painting quality highly depends on the quality of the compressed air. Modern paint systems inject the paint into the paint gun, where compressed air is driving the paint through the nozzle. When existing the nozzle, the paint atomizes into a fine and uniformed mist. These tiny paint particles repel each other as they are leaving the nozzle and stick to the object being painted.

Excess impurities in the compressed air will cause the paint particles to "clump", resulting in uneven coverage and an inconsistent finish.

The only way to secure this high-quality painting process is by monitoring the particle concentration of the compressed air supply.

Air Quality Monitoring according to the ISO 8573-1

The ISO 8573-1 defines the compressed air purity classes for particulates in a compressed air system by providing the limit values for each channel.

The S132 Laser Particle Counter measures the channels as defined by the ISO 8573-1:

- $0.1 < d \leq 0.5 \mu\text{m}$
- $0.5 < d \leq 1.0 \mu\text{m}$
- $1.0 < d \leq 5.0 \mu\text{m}$



For these 3 channels, the limit values are defined and divided into classes.

But furthermore, as stated in the ISO 8573, the fourth channel must be measured as well:

- $d > 5.0 \mu\text{m}$

This channel value must be 0 for the classes 0 ... 5, as otherwise the classification falls into class 6 or worse, where a mass concentration is defined as limit values.

Certain industries like the pharmaceutical and food industry requires high-quality compressed air. By meeting the ISO 8573-1 standard requirements you can:

- 
Ensure Process and Product Safety:
 Contaminants mixing with applications effect product results and can create safety concerns.
- 
Prevent production downtime:
 Processes and machines are stopped to find and eliminate the contamination issues.

S130



S132



Technical Data

Measurement

Particle

Measuring range	S130: $0.3 < d \leq 5.0 \mu\text{m}$ S132: $0.1 < d \leq 5.0 \mu\text{m}$
Measuring channels	S130: CH1: $0.3 < d \leq 0.5 \mu\text{m}$ CH2: $0.5 < d \leq 1.0 \mu\text{m}$ CH3: $1.0 < d \leq 5.0 \mu\text{m}$ CH4: $5.0 \mu\text{m} < d$ (configurable) S132: CH1: $0.1 < d \leq 0.5 \mu\text{m}$ CH2: $0.5 < d \leq 1.0 \mu\text{m}$ CH3: $1.0 < d \leq 5.0 \mu\text{m}$ CH4: $5.0 \mu\text{m} < d$ (configurable)
Counting Efficiency according ISO 21501-4	30 ... 70 % of $d > 0.1 \mu\text{m}$ 90 ... 110 % of $d \geq 0.3 \mu\text{m}$
Principle of measurement	Laser detection
Sensor	LED-laser

Consumption

Selectable units	$\text{cn}/\text{m}^3, \text{cn}/\text{ft}^3$
------------------	---

Signal / Interface & Supply

Analog output

Signal	4 ... 20 mA (2-wire)
Alarm	Switch output, normally open, max. 40 VDC, 200 mA

Fieldbus

Protocol	Modbus/RTU, Modbus/TCP (with Display version)
----------	---

Supply

Voltage supply	24 VDC / 10 W (without Display) 24 VDC / 20 W (with Display)
Current consumption	420 mA (without Display) 840 mA (with Display)

Data interface

USB	USB Micro with OTG support
-----	----------------------------

General data

Configuration

Others	Device comes pre-configured Configuration can be done via on-screen touch
--------	--

Display

Integrated	5" color touch screen
------------	-----------------------

Data Logger

Storage	30 million measurement values (optional)
---------	--

Miscellaneous

Electrical connection	3X M12
Protection class	IP65
Process connection	6 mm quick connect (pressurized version), barb connection (ambient version)
Material	PC, Al alloy
Weight	S130: 1.9 kg S132: 3.2 kg
Dimensions	S130: 271 x 205 x 91 mm S132: 300 x 240 x 120 mm

Operating conditions

Medium	Compressed air and gases free of corrosive, aggressive, caustic and flammable constituents
Flow rate	2.83 l/min
Sample rate	One sample per minute
Medium quality	ISO 8573-4
Medium temperature	0 ... +40 °C
Medium humidity	< 90 %, no condensation
Operating pressure	0.3 ... 1.5 MPa
Ambient temperature	+10 ... +40 °C
Ambient humidity	0 ... 90 % rH
Storage temperature	-10 ... +50 °C
Storage humidity	< 90 % with no condensation
Transport temperature	-30 ... +70 °C Without display -10 ... +60 °C with display

Ordering

Please use the following tables to assist in placing your order with our sales staff.

Particle Counter for Compressed Air: P = 0.3 ... 1.5 Mpa

Order No.	Description
-----------	-------------

S604 1303	S130, Particle Counter for Compressed Air, size range d: $0.3 < d \leq 5.0 \mu\text{m}$, 2.83 l/min
S604 1305	S130, Particle Counter for Compressed Air, size range d: $0.3 < d \leq 5.0 \mu\text{m}$, 2.83 l/min, display, logger
S604 1308	S132, Particle Counter for Compressed Air, size range d: $0.1 < d \leq 5.0 \mu\text{m}$, 2.83 l/min
S604 1309	S132, Particle Counter for Compressed Air, size range d: $0.1 < d \leq 5.0 \mu\text{m}$, 2.83 l/min, display, logger

Accessories

Order No.	Description
-----------	-------------

A554 0120	Transport case S120 / S130
A554 0116	Transport case S132
A554 1204	Zero count filter
R200 0130	Calibration particle counter S130
R200 0131	Calibration particle counter S132

S600

Portable Compressed Air Purity Analyzer



**ISO 8573-1
ALL IN ONE**
Particle concentration,
Dew Point, Oil vapor

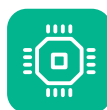

**GUIDED
MEASUREMENT**
Software guided air
quality audits



**PORTABLE
MULTI-TOOL**
Can be carried
with one hand



**HIGH
PRECISION**
Accurate
measurements



**COMPACT
DESIGN**
Makes it
unique



**PDF
REPORTING**
Create ISO 8573-1
reports on the device



Benefits

- ✓ All-in-one device measures Particle concentration, dew point and oil vapor
- ✓ Measures additionally the temperature and pressure
- ✓ Software guided measurement makes it easy to generate reliable results
- ✓ Report generator creates PDFs for ISO 8573-1 audits
- ✓ Ultra portable and compact design

Plug & Play Measurement — Save Precious Time

ISO 8573 compliant purity quantifications of compressed air systems are bound to time-consuming installations and long-lasting test runs ... It's time for a revolution: The S600 is unlike its competition.

It combines the latest sensor technology, software-guided measurements and a time-saving setup into a handy, touchscreen controlled multi-tool. With our S600 you will finish measurement runs in much less time than with your traditional method, after that you don't even want to leave your new comfort zone again. Trust us.

Remote connection

By connecting a LTE/4G modem to the designated USB port, S600 can be monitored remotely through S4A software

Monitoring of All Relevant Contaminants



Particle Concentration Measurement

$0.1 < d \leq 0.5 \mu\text{m}$ / $0.5 < d \leq 1.0 \mu\text{m}$ / $1.0 < d \leq 5.0 \mu\text{m}$ / $5.0 \mu\text{m} < d$



Dew Point Measurement

-100 ... +20 °C Td



Oil Vapor Measurement

0.001 ... 5.000 mg/m³

ISO 8573-1 Classification

Environment

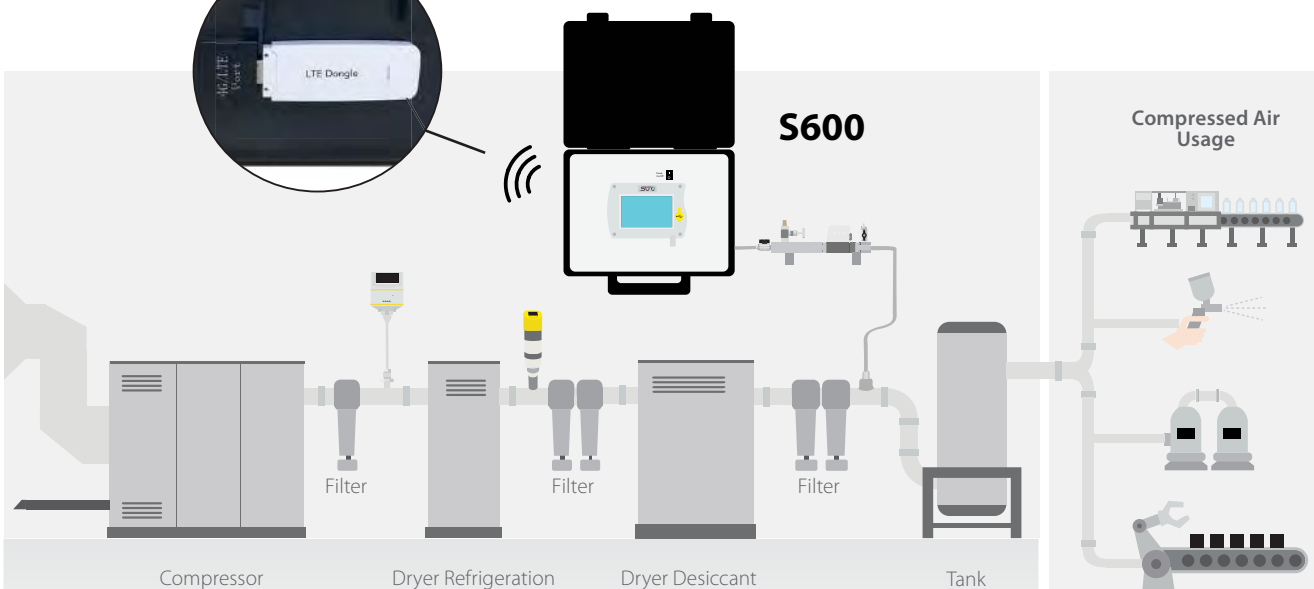

5 in 1 Measuring Device

The S600 is the portable multi-tool for ISO 8573-1 compressed air purity measurements. It measures, records and validates quality parameters like particle concentration, dew point, oil vapor contents, temperature and the pressure of compressed air systems.



Particle Concentration Measurement

- Measurement methods according to ISO 8573-4 standards (together with isokinetic sampling device)
- Latest laser detection technology
- Smallest particle size 30 ... 70 %, next bigger sizes 90 ... 110 % per ISO 21501-4



Dew Point Measurement

- Large ranges due to the unique multiple sensor technology
- Long-term stable and well-proven measurement methods
- High precision with an accuracy of ± 2 °C Td



Oil Vapor Measurement

- Latest photoionisation detector (PID) with self-calibration
- Measuring range according to ISO 8573-1 Class 1 to Class 5
- High precision with 5 % of reading ± 0.003 mg/m³ accuracy



Pressure Measurement

- State of the art sensor technology
- Additional quality data about the compressed air system



Integrated Data Logger

- Integrated data logger records all channels in parallel for later analysis
- 5" touchscreen allows you to interact with the device on site. There is no need for a PC to manage the device.

ISO 8573-4 Isokinetic Sampling Device

For particle measurements according to ISO 8573 an isokinetic sampling tube has been designed. This optional equipment enables you to monitor and adjust the air flow of the particle measurement to ensure the correct isokinetic sampling.



Applications

- ✓ Air quality measurements in medical, pharmaceutical, food and beverage applications
- ✓ Compressed air quality audits in regards to the ISO 8573-1
- ✓ Point-of-use measurements to ensure process safety and quality in all applications
- ✓ Monitoring of high tech applications with strict air purity requirements

Create Compressed Air Quality Reports

The S600 enables users to create powerful PDF reports directly on site. The reports are following the recommendations stated in the ISO 8573, additionally customer related data as well as service provider details can be entered on-screen, making it even easier to perform audits and to create meaningful reports.

PDF reports can be created from any recordings on the device and are copied on the fly to a connected USB drive for direct print-outs.

Air Purity Report		SUTCO	
S600 Compressed Air Purity Analyzer		Be smart. Measure it.	
Measurement device			
Model:	S600	Company:	SUTCO TEC GmbH
Manufacture:	SUTCO TEC	Phone:	049 7834 504 88 00
Label calibration:	22. June 2022	Email:	info@sutco-tec.com
Serial number:	1234 5678		
Location information		Service provider	
Customer:	Customer GmbH	Company:	SUTCO TEC GmbH
Tester name:	Max Mustermann	Phone:	049 7834 504 88 00
Measurement Location:	Prod. Line 1	Email:	info@sutco-tec.com
Measurement Point:	Machine 1		
Target classes ISO 8573-1 (reference values)		Measurement information	
Particle:	2	Measurement started:	14:56:00 22. August 2021
Humidity:	3	Measurement stopped:	15:28:00 22. August 2021
Oil:	2	Measurement duration:	00:30:00
Measurement results			
System Measurement conditions			
Medium Temperature [°C]:	31.0	Gas Type:	Air
Medium Pressure [bar]:	5.62	Particle counter flow rate:	2.83 l/min \pm 0.03 l/min
Declared Particle concentration in cm³ (# = Particle size) (referring to 20 °C, 100 kPa)			
Class	Measurement	Reference	ISO 8573-1 Class measured
0.1 µm + 0.5 µm	< 400000	200000	passed
0.3 µm + 0.5 µm	< 6000	5000	passed
1.0 µm + 0.5 µm	< 100	60	passed
0 + 5.0 µm	< 0	0	passed
Declared Pressure dew point in °C (referring to actual and reference conditions 20 °C, 1 bar(g))			
Measurement	Reference	ISO 8573-1 Class measured	
Actual conditions	16.5 °C	24.0 °C	2
20 °C / 1 bar(g)	< -20.0	-22.7	passed
Declared content of Oil vapour in mg/m³ (referring to 20 °C, 100 kPa)			
Measurement	Reference	ISO 8573-1 Class measured	
Actual conditions	< 0.3	0.008	passed
20 °C / 100 kPa	< 0.3	0.008	passed
Measurement equipment			
Particle concentration:	Laser optical particle counter	Accuracy: 90% @ 0.1 + 0.3 µm, 100% @ 0.1 + 0.3 µm	Range: 0.1 + 0.3 µm + 0.3 µm
Pressure dew point:	Polymer + QCM sensor	Accuracy: ± 0.1 °C	Range: 100 ... 100 °C Td
Oil vapour:	PID Sensor	Accuracy: ± 0.01 or 10% measured value ± 0.003 mg/m ³	Range: 0.01 ... 0.020 mg/m ³
Approval			
Signature Tester:	Signature Customer:	Place / Date:	
Date: _____			

ISO 8573-1 Compressed Air Classes

ISO 8573-1:2010 is the main publication of the ISO 8573 series of standards, because it contains the permissible amount of contaminants per cubic meter of compressed air is fixed.

Class	Particle Concentration			Pressure Dew Point	Oil Concentration
	cn/m ³			°C (°F)	mg/m ³
	0.1 < d ≤ 0.5 μm	0.5 < d ≤ 1.0 μm	1.0 < d ≤ 5.0 μm		
0	As specified by the equipment user or supplier and more stringent than class 1				
1	≤ 20,000	≤ 400	≤ 10	≤ -70 (94.0)	≤ 0.01
2	≤ 400,000	≤ 6,000	≤ 100	≤ -40 (-40.0)	≤ 0.1
3	not specified	≤ 90,000	≤ 1,000	≤ -20 (-4.0)	≤ 1
4	not specified	not specified	≤ 10,000	≤ +3 (+37.4)	≤ 5
5	not specified	not specified	≤ 100,000	≤ +7 (+45.6)	> 5
6	x	x	x	≤ +10 (+50.0)	x

Why should you focus on your ISO 8573-1 specifications?

Certain industries like the pharmaceutical and food industry requires high-quality compressed air. By meeting the ISO 8573-1 standard requirements you can:

- ✔ **Ensure Process and Product Safety:**

Potential incidents, like contaminants meeting food via water and oil, can create safety concerns and unreliable processes.
- ✔ **Avoid Production Failures and Poor Quality Finishes:**

Contaminants mixing with applications effect product results.
- ✔ **Prevent production downtime:**

Processes and machines are stopped to find and eliminate the contamination issues.

Dimensions



Technical Data

Measurement

Particle concentration

Accuracy	Counting Efficiency according ISO 21501-4 30 ... 70 % of $d > 0.1 \mu\text{m}$ 90 ... 110 % of $d \geq 0.3 \mu\text{m}$
----------	---

Selectable units	cn/m^3 , cn/ft^3
------------------	--

Measuring range	$0.1 < d \leq 0.5 \mu\text{m}$
	$0.5 < d \leq 1.0 \mu\text{m}$
	$1.0 < d \leq 5.0 \mu\text{m}$
	$5.0 \mu\text{m} < d$

Sensor	Laser optical particle counter
--------	--------------------------------

Sampling rate	1 min.
---------------	--------

Flow rate	2.83 l/min
-----------	------------

Pressure Dew Point

Accuracy	$\pm 1 \text{ }^\circ\text{C Td}$ (0 ... 20 $^\circ\text{C Td}$)
	$\pm 2 \text{ }^\circ\text{C Td}$ (-70 ... 0 $^\circ\text{C Td}$)
	$\pm 3 \text{ }^\circ\text{C}$ (-100 ... -70 $^\circ\text{C Td}$)

Selectable units	$^\circ\text{C}$, $^\circ\text{F}$
------------------	-------------------------------------

Measuring range	-100 ... +20 $^\circ\text{C Td}$
-----------------	----------------------------------

Sensor	QCM + Polymer
--------	---------------

Response time (t90)	-20 $^\circ\text{C Td}$ -> -60 $^\circ\text{C Td}$ = < 240 sec
	-60 $^\circ\text{C Td}$ -> -20 $^\circ\text{C Td}$ = < 30 sec @ 4 l/min

Oil vapor

Accuracy	5 % of value +/- 0.003 mg/m^3
----------	---

Detection limit	0.003 mg/m^3
-----------------	------------------------------

Resolution	0.001 mg/m^3
------------	------------------------------

Selectable units	mg/m^3
------------------	------------------------

Measuring range	0.001 ... 5.000 mg/m^3
-----------------	--

Sensor	PID (Photoionisation detector)
--------	--------------------------------

UV lamp lifetime	1 year or 6000 working hours, whichever comes first
------------------	---

Sampling rate	1 sec.
---------------	--------

Pressure

Accuracy	0.5 % FS
----------	----------

Measuring range	0.1 ... 1.6 MPa(g)
-----------------	--------------------

Sensor	Piezo resistive sensor
--------	------------------------

Temperature

Accuracy	$\pm 0.3 \text{ }^\circ\text{C}$
----------	----------------------------------

Measuring range	-30 ... +70 $^\circ\text{C}$
-----------------	------------------------------

Sensor	Pt100
--------	-------

Reference conditions

Selectable conditions	ISO1217 20 $^\circ\text{C}$ 1000 mbar
-----------------------	---------------------------------------

Signal / Interface & Supply

Fieldbus

Protocol	Modbus/TCP
----------	------------

Update rate	1 / sec.
-------------	----------

Power Supply

Voltage supply	Mains supply adapter (AC/DC)
	Input: 100 ... 240 VAC, 50/60 Hz, 1.4 A
	Output: 24 VDC, 2.5 A, 60 W max.

Current consumption	1.4 A
---------------------	-------

Interface

USB	USB Micro with OTG support
-----	----------------------------

LTE/4G USB	USB Port for 4G/LTE Modem
------------	---------------------------

General data

Configuration

Others	Device comes pre-configured Configuration can be done via on-screen touch
--------	--

Display

Integrated	Touchscreen, Size: 5", Resolution: 800 x 480 px
------------	---

Data Logger

Storage	Up to 3 million recorded data sets (10 channels each)
---------	---

Report	Integrated report generator for PDF export
--------	--

Material

Process connection	Brass nickel-plated, FKM
--------------------	--------------------------

Housing	PC + ABS, Al alloy
---------	--------------------

Miscellaneous

Electrical connection	2-Pin, push-pull socket
-----------------------	-------------------------

Protection class	IP54 (cover lid closed)
------------------	-------------------------

Approvals	IEC 61326-1
-----------	-------------

Process connection	Micro quick connector, full passthrough, male (1.5 m hose with coupling included)
--------------------	---

Weight	9.8 kg
--------	--------

Operating conditions

Medium	Compressed Air, Nitrogen N2, Carbon dioxide CO ₂ (software setting)
--------	--

Medium quality	ISO 8573-1: 4.4.4 or better
----------------	-----------------------------

Medium temperature	0 ... +40 $^\circ\text{C}$
--------------------	----------------------------

Medium humidity	Medium humidity < 40 % rH, no condensation
-----------------	--

Operating pressure	0.3 ... 1.5 MPa(g)
--------------------	--------------------

Ambient temperature	0 ... +50 $^\circ\text{C}$
---------------------	----------------------------

Ambient humidity	0 ... 90 % rH
------------------	---------------

Storage temperature	-10 ... +70 $^\circ\text{C}$
---------------------	------------------------------

Transport temperature	-10 ... +70 $^\circ\text{C}$
-----------------------	------------------------------

Technical Data

Isokinetic Sampling Device

Measurement

Isokinetic Sampling Device

Measuring unit	Measuring unit Sampling pipe with integrated isokinetic sampling tube, flow regulation and control by integrated flow sensor, to be used for particle measurements according to ISO 8573-4
Flow meter unit	Thermal mass flow meter (only for isokinetic flow setup, no system flow measurement)
Sensor	Thermal mass flow sensor
Accuracy	3 % o. RDG

Signal Interface & Supply

Connection	Communication to S600 (cable included)
Update rate	1 / sec.

General data

Material

Process connection	Brass nickel-plated, FKM
Housing	PC + ABS, Al alloy
Main unit	Al alloy
Isokinetic tube	Stainless steel 1.4404 (SUS 316L)

Miscellaneous

Electrical connection	M8
Protection class	IP54 IEC 61326-1
Process connection	Micro quick connector, full passthrough, male (1.5 m hose with coupling included)

Operating conditions

Medium	Compressed Air, Nitrogen N ₂ , Carbon dioxide CO ₂ (software setting)
Medium quality	ISO 8573-1: 4.4.4 or better
Medium temperature	0 ... + 40 °C
Medium humidity	Medium humidity < 40 % rH, no condensation
Operating pressure	0.3 ... 1.5 MPa(g)
Ambient temperature	0 ... +50 °C
Ambient humidity	0 ... 90 % rH
Storage temperature	-10 ... + 70 °C
Transport temperature	-10 ... + 70 °C

Dimensions Isokinetic Sampling Device

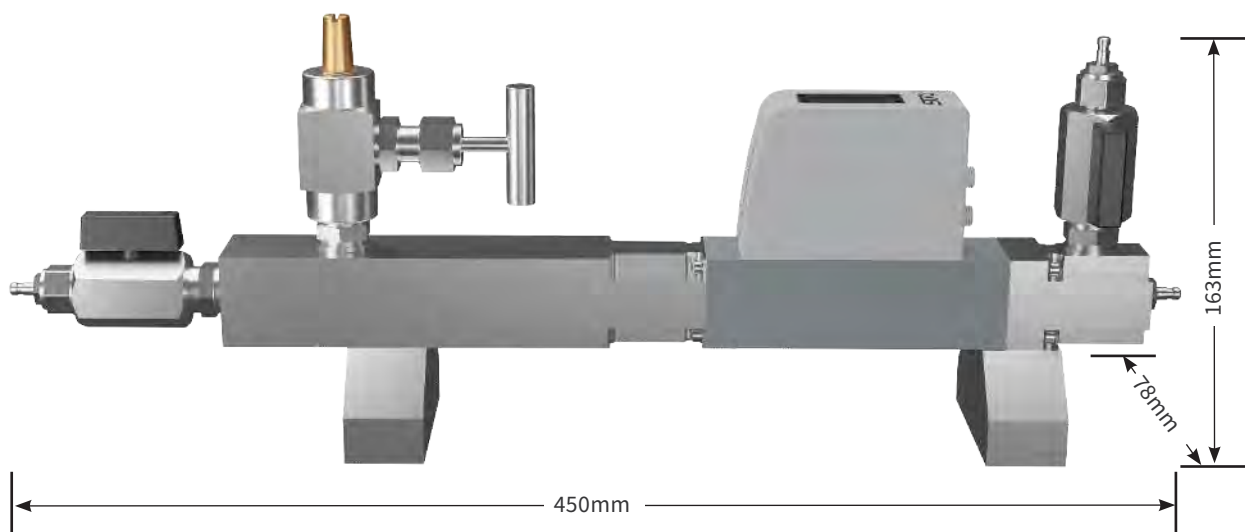

Ordering

Please use the following tables to assist in placing your order with our sales staff.

S600 Compressed Air Purity Analyzer (Portable Version)

Order No.	Description
P560 0600	<p>Touch screen interface, data logger, guided measurement, PDF report generator, USB port and Ethernet port with Modbus/TCP</p> <p>Particle d: $0.1 < d \leq 0.5, \mu\text{m}$ $0.5 < d \leq 1.0 \mu\text{m}$, $1.0 < d \leq 5.0 \mu\text{m}$, $d > 5.0 \mu\text{m}$</p> <p>Dew point: $-100 \dots +20 \text{ }^\circ\text{C Td}$</p> <p>Oil vapor: $0.001 \dots 5.000 \text{ mg/m}^3$</p> <p><u>Including:</u></p> <ul style="list-style-type: none">• Portable compressed air analyzer in a hand carry case with handle and shoulder belt• USB OTG memory stick• Purge filter for pre-measurement (test kit)• Power supply, 230 VAC / 24 VDC 50/60 Hz• 2 x Connection hose 1.5 m, one end quick coupling, one end compressed air coupling• Certificate of calibration• Operation and instruction manual
A1670	USB 4G dongle for S551/S600, including S4A software

Isokinetic Sampling Device

Order No.	Description
A554 0600	<p>Isokinetic sampling device for particle measurement according to ISO 8573</p> <p><u>Including:</u></p> <ul style="list-style-type: none">• Isokinetic sampling pipe• Flow sensor mounted on pipe• Certificate of calibration• Connection cable to S600• Connection hose 150 mm, both ends quick coupling• Connection hose 700 mm, both ends quick coupling• Connection hose 1.5 m, one end quick coupling, one end compressed air coupling• Transport case to carry the device, hoses and cables

S601

Stationary Compressed Air Purity Monitor



ALL IN ONE
Dew point, particle and oil vapor



TOUCH SCREEN
5" large color LCD



INDUSTRIAL DESIGN
For outdoor applications



PRECISION
Accurate measurements



COMPACT DESIGN
Can be installed anywhere



Benefits

- ✓ All-in-one device measures particle concentration, dew point and oil vapor
- ✓ Measures additionally the temperature and pressure
- ✓ Software guided measurement makes it easy to generate reliable results
- ✓ Real time information can be retrieved from the S601 by SCADA systems via MODBUS outputs
- ✓ Compact design and easy setup, just connect the unit to power and the compressed air supply

Constant Measurement — 24/7 Monitoring

The S601 combines three major quality measurements into a single wall mountable device. Optimized to be used as Plug & Play system, the S601 helps users to identify the air quality at a glance.

The robust cabinet makes it well suited for rough industrial applications.

A stainless steel cabinet is offered on request, which is suited for pharmaceutical and medical applications.

The S601 combines the latest sensor technology and a time-saving setup into a one of its kind multi-tool. Mount it, power it, connect it and measure. Trust us, it is that easy.

Monitoring of All Relevant Contaminants



Particle Concentration Measurement

$0.1 < d \leq 0.5 \mu\text{m}$ / $0.5 < d \leq 1.0 \mu\text{m}$ / $1.0 < d \leq 5.0 \mu\text{m}$ / $5.0 \mu\text{m} < d$



Dew Point Measurement

-100 ... +20 °C Td



Oil Vapor Measurement

0.001... 5.000 mg/m³

ISO 8573-1 Classification

Alarm Management
Modbus RTU / TCP
Monitoring Software



Environment



impurities in the ambient air

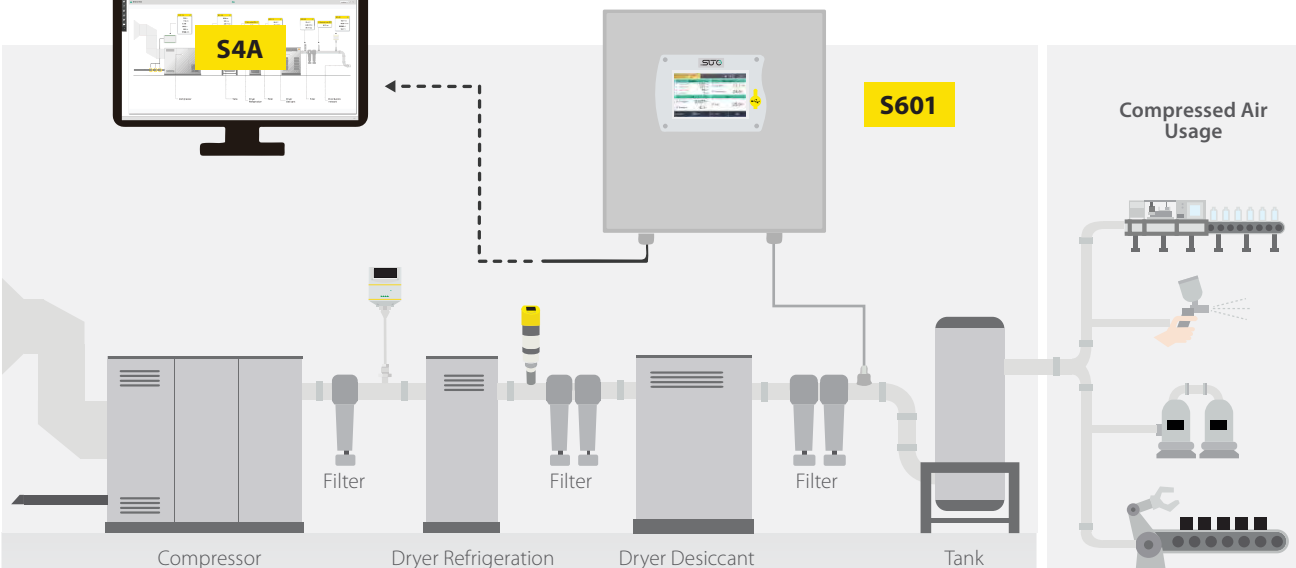



Various Applications

- ✓ Air quality measurements in medical, pharmaceutical, food and beverage applications
- ✓ Compressed air quality audits in regards to the ISO 8573-1
- ✓ Point-of-use measurements to ensure process safety and quality in all applications
- ✓ Monitoring of high tech applications with strict air purity requirements

5 in 1 Measuring Device

The S601 is the stationary multi-tool for compressed air purity measurements. It measures, records and validates quality parameters like particles, dew point, oil vapor contents, temperature and the pressure of compressed air systems. It offers different signal outputs to seamlessly integrate it into your system. The integrated logger stores the recorded values safely.



Particle Concentration Measurement

- Measurement methods according to ISO 8573 standards
- Latest laser detection technology
- Smallest particle size 30 ... 70 %, next bigger sizes 90 ... 110 % per ISO 21501-4



Integrated Data Logger

- Integrated data logger records all channels in parallel for later analysis
- 5" touchscreen allows you to interact with the device on site
- There is no need for a PC to manage the device



Oil Vapor Measurement

- Latest photoionisation detector (PID) with self-calibration
- Wide range of oil vapor concentrations
- High precision with 5 % of reading \pm 0.003 mg/m³ accuracy



Dew Point Measurement

- Large ranges thanks to the unique multiple sensor technology
- Long-term stable and well-proven measurement methods
- Outstanding precision with a high accuracy over the full range from -100 to +20 °C Td



Pressure Measurement

- State of the art sensor technology
- Additional quality data about the compressed air system

Modular Concept

The S601 is based on a modular concept which enables the client to decide which type of measurement needs to be performed.

This makes the S601 customizable and flexible to offer the end-user the best suited instrument to finish the desired measurement tasks.



ISO 8573-1 Compressed Air Classes

ISO 8573-1:2010 is the main publication of the ISO 8573 series of standards, because it contains the permissible amount of contaminants per cubic meter of compressed air is fixed.

Class	Particle Concentration			Pressure Dew Point	Oil Concentration
	cn/m ³			°C (°F)	mg/m ³
	0.1 < d ≤ 0.5 μm	0.5 < d ≤ 1.0 μm	1.0 < d ≤ 5.0 μm		
0	As specified by the equipment user or supplier and more stringent than class 1				
1	≤ 20,000	≤ 400	≤ 10	≤ -70 (94.0)	≤ 0.01
2	≤ 400,000	≤ 6,000	≤ 100	≤ -40 (-40.0)	≤ 0.1
3	not specified	≤ 90,000	≤ 1,000	≤ -20 (-4.0)	≤ 1
4	not specified	not specified	≤ 10,000	≤ +3 (+37.4)	≤ 5
5	not specified	not specified	≤ 100,000	≤ +7 (+45.6)	> 5
6	x	x	x	≤ +10 (+50.0)	x

Why should you focus on your ISO 8573-1 specifications?

Certain industries like the pharmaceutical and food industry requires high-quality compressed air. By meeting the ISO 8573-1 standard requirements you can:

- ✔ **Ensure Process and Product Safety:**

Potential incidents, like contaminants meeting food via water and oil, can create safety concerns and unreliable processes.
- ✔ **Avoid Production Failures and Poor Quality Finishes:**

Contaminants mixing with applications effect product results.
- ✔ **Prevent production downtime:**

Processes and machines are stopped to find and eliminate the contamination issues.

Dimensions

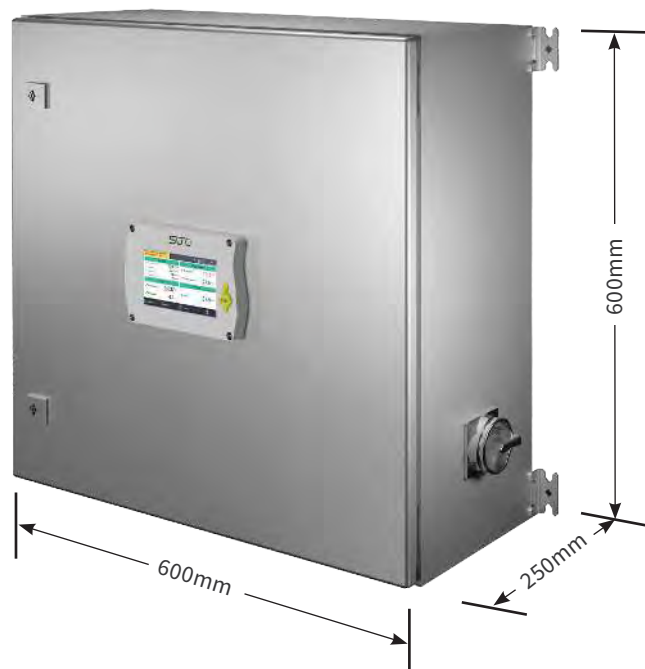

Technical Data

Measurement

Particle concentration

Accuracy	Counting Efficiency according ISO 21501-4	
	Option A1263:	Option A1260:
	30 ... 70 % of d > 0.1 µm	50 % @
	90 ... 110 % of d ≥ 0.3 µm	0.1 < d ≤ 0.15 µm
		100 @ d > 0.15 µm

Selectable units cn/m³, cn/ft³

Measuring range	Option A1263:	Option A1260:
	0.1 < d ≤ 0.5 µm	0.3 < d ≤ 0.5 µm
	0.5 < d ≤ 1.0 µm	0.5 < d ≤ 1.0 µm
	1.0 < d ≤ 5.0 µm	1.0 < d ≤ 5.0 µm
	5.0 µm < d	5.0 µm < d

Sensor Laser optical particle counter

Sampling rate 1 min.

Flow rate 2.83 l/min

Pressure Dew Point

Accuracy	± 1 °C Td (0 ... 20 °C Td)
	± 2 °C Td (-70 ... 0 °C Td)
	± 3 °C (-100 ... -70 °C Td)

Selectable units °C, °F

Measuring range -100 ... +20 °C Td

Sensor QCM + Polymer

Response time
(t₉₀)
-20 °C Td -> -60 °C Td = < 240 sec
-60 °C Td -> -20 °C Td = < 30 sec
@ 4 l/min

Oil vapor

Accuracy 5 % of value +/- 0.003 mg/m³

Detection limit 0.003 mg/m³

Resolution 0.001 mg/m³

Selectable units mg/m³

Measuring range 0.001 ... 5.000 mg/m³

Sensor PID (Photoionisation detector)

UV lamp lifetime 1 year or 6000 working hours, whichever comes first

Sampling rate 1 sec.

Pressure

Accuracy 0.5 % FS

Measuring range 0.1 ... 1.6 MPa(g)

Sensor Piezo resistive sensor

Temperature

Accuracy ± 0.3 °C

Measuring range -30 ... +70 °C

Sensor Pt100

Reference conditions

Selectable conditions ISO1217 20 °C 1000 mbar

Signal / Interface & Supply

Fieldbus

Protocol Modbus/TCP

Update rate 1 / sec.

Alarm output

Relay 2 x Changeover Relay (freely programmable)

Rating 230 VAC, 3A

Power Supply

Voltage supply 100 ... 240 VAC, 50/60 Hz

Current consumption 50 VA

Interface

USB USB Micro with OTG support

General data

Configuration

Others Device comes pre-configured
Configuration can be done via on-screen touch

Display

Integrated Touchscreen, Size: 5", Resolution: 800 x 480 px

Data Logger

Storage Up to 3 million recorded data sets (10 channels each)

Material

Process connection Brass nickel-plated, FKM

Housing Sheet steel, powder coated cabinet

Miscellaneous

Electrical connection AC Clamp Terminals, M12, RJ45

Protection class IP54 (cover lid closed)

Approvals CE

Process connection Micro quick connector, full passthrough, male (1.5 m hose with coupling included)

Weight 15 kg

Operating conditions

Medium Compressed Air, Nitrogen N₂, Carbon dioxide CO₂ (software setting)

Medium quality ISO 8573-1: 4.4.4 or better

Medium temperature 0 ... +40 °C

Medium humidity Medium humidity < 40 % rH, no condensation

Operating pressure 0.3 ... 1.5 MPa(g)

Ambient temperature 0 ... +50 °C

Ambient humidity 0 ... 90 % rH

Storage temperature -10 ... +70 °C

Transport temperature -10 ... +70 °C

Ordering

Please use the following tables to assist in placing your order with our sales staff.

S601 Stationary Compressed Air Purity Monitor

Order No.	Description
-----------	-------------

D500 0601	S601 Stationary Compressed Air Purity Monitor Touch screen interface, data logger , metal cabinet for wall mounting Supply voltage 100 ... 240 V AC, Inlet pressure 0.3 ... 1.5 MPa
-----------	---

Including:

- Dew point measurement rig -100 ... +20 °C Td
- 2 m PTFE hose
- 1.5 m PTFE hose with quick connector
- Purge unit for measuring point cleaning
- USB OTG memory stick
- S4A Software for logger read out and analysis
- 1 x PTFE hose adapter
- Certificate of calibration

Particle counter

A1260	Integrated particle counter rig, 0.3 < d ≤ 0.5 µm, 0.5 < d ≤ 1.0 µm, 1.0 < d ≤ 5.0 µm, 2.83 l/min
-------	---

A1263	Integrated particle counter rig, 0.1 < d ≤ 0.5 µm, 0.5 < d ≤ 1.0 µm, 1.0 < d ≤ 5.0 µm, 2.83 l/min
-------	---

Oil vapor measurement

A1267	Integrated oil vapor sensor rig, 0.001 ... 5.000 mg/m ³
-------	--

S605

Portable Breathing Air Quality Analyzer



**Coming
Soon!**



ALL IN ONE
O₂, CO₂, CO, H₂O,
Oil, Pressure



PLUG & PLAY
Simple connection
to your system



PORTABLE DEVICE
Can be carried
with one hand



**HIGH
PRECISION**
Accurate
measurements



**COMPACT
DESIGN**
Simple and
efficient handling



**COMMUNICATION
INTERFACE**
Modbus TCP/RTU,
4G-Modem



Benefits

- ✓ All-in-one Instrument measures O₂, CO₂, CO, Dew Point and Oil Vapor simultaneously in the breathing air
- ✓ Portable and lightweight measuring device in a robust carry case
- ✓ Testing quality of breathing air according to national and international standards
- ✓ Software guided measurement makes it easy to generate reliable results and reports
- ✓ Only one gas inlet for all parameters
- ✓ Integrated data logger saves data for later analysis

Real-time breathing air quality measurements

The purity of the breathing air is vital for the operators health and safety. It is essential to have regular purity checks of the supplied air.

The SUTO S605 Portable Breathing Air Quality Analyzer, measures O₂, CO₂, CO, Dew Point, Oil Vapor and Pressure as defined in the breathing air purity standards and instantly shows the measured values on the touch screen display.

The robust design, quick sensor response times, and a user-friendly user interface ensures reliable and quick measurements, resulting in maximum protection for the people using air for breathing applications.

It is smarter, faster and more convenient than the traditional methods.

Monitoring of all breathing air parameters

O ₂	Oxygen	CO	Carbon Monoxide
CO ₂	Carbon Dioxide	H ₂ O	Humidity
According to all relevant national and international standards		OIL	Oil Residues

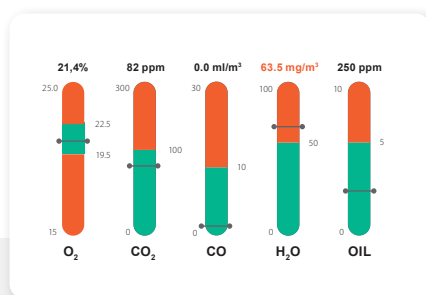

4G Remote Connection to S4A Monitoring Software

Breathing Air



Environment



Compressor

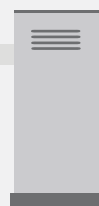

Purification



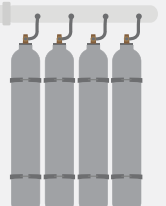

Air Receiver Tank



Reserve Air System

7 in 1 Measurement Device

- O₂** **Oxygen Measurement**
 For safety reasons, it is recommended to measure the oxygen level in the breathing air. The optical oxygen sensor monitors the O₂ content and indicates deviations from the standard concentration.
- CO₂** **Carbon Dioxide Measurement**
 The intake air may also be exposed to increased concentration of carbon dioxide. Filter material used in compressed air can adsorb, but also release CO₂. The gas is measured by the NDIR sensor to avoid extreme concentrations above 1000 ppm.
- CO** **Carbon Monoxide Measurement**
 The compressor intake air may be contaminated with CO due to nearby combustion engines or heating systems. Carbon monoxide is a toxic and life-threatening gas which will be monitored accurately by an electrochemical sensor.
- H₂O** **Humidity Measurement**
 High humidity can cause corrosion and in severe cases lead to bursting air containers. In cold environment, it can freeze and block the air supply. The integrated dew point sensor is crucial to check the proper water removal of the dryers and filters.
- OIL** **Oil Vapor Measurement**
 Atmospheric oil vapor contained in industrial air environment can get into the system through the compressor intake. Compressed into the breathing air, the oil contaminants can cause health issues. The state-of-the-art sensor technology detects the oil contaminants immediately.
-  **Pressure Measurement**
 The pressure sensor provides additional pressure data about the compressed air system using state of the art sensor technology.
-  **Integrated Data Logger**
 The integrated data logger records all channels in parallel for later analysis. The 5" touchscreen allows you to interact with the device on site. There is no need for a PC to manage the device.

Create Breathing Air Quality Reports

The S605 enables users to create powerful PDF reports directly on site. Customer related data as well as service provider details can be entered on-screen, making it even easier to perform audits and to create meaningful reports.

PDF reports can be created from any recordings on the device and are copied on the fly to a connected USB drive for direct print-outs.

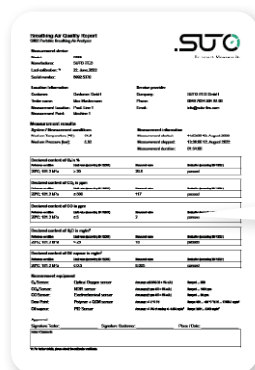

Applications

Operators of breathing air systems are required to fill respiratory air in line with international standards such as EN 12021 or CFSR 1910.134(d). Potential hazards due to impurities in the breathing air can have consequences which endanger health or which are even life-threatening.

Regular checks with the Breathing Air Quality Analyzer S605 is an indispensable part for a safe operation.

Remote Connection

By connecting a 4G/LTE modem to the designated USB port, S605 can be monitored remotely through S4A software.



Measurement results		
System / Measurement conditions		
Medium Temperature [°C]:	31.0	
Medium Pressure [bar]:	5.02	
Measurement information		
Measurement started:	11:52:00	12. August 2022
Measurement stopped:	13:26:00	12. August 2022
Measurement duration:	01:34:00	
Declared content of O₂ in %		
Reference condition	Unit value (according DIN 5280)	Measured value
20°C; 101.3 kPa	≥ 20	21.6
Declared content of CO₂ in ppm		
Reference condition	Unit value (according DIN 5280)	Measured value
20°C; 101.3 kPa	≤ 500	117
Declared content of CO in ppm		
Reference condition	Unit value (according DIN 5280)	Measured value
20°C; 101.3 kPa	≤ 5	2
Declared content of H₂O in mg/m³		
Reference condition	Unit value (according DIN 5280)	Measured value
20°C; 101.3 kPa	≤ 25	10
Declared content of Oil vapour in mg/m³		
Reference condition	Unit value (according DIN 5280)	Measured value
20°C; 101.3 kPa	≤ 0.5	0.005
Measurement equipment		

Relevant standards for breathing air

Relevant standards including BS EN 12021, DEF STAN 68-284, OSHA, CSA and BS 8478 require adherence to specific limits of constituents in breathing air. Here some examples of the required for industrial breathing air:

Contaminant	Europe	China	USA	Canada
Standard	EN 12021	GB/T 31975-2015	CFSR	CSA
O₂	20 -22 %	19.5 - 23.5 %	19.5 - 23.5 %	20 – 22 %
CO₂	500 ppm	≤ 1000 mL/m ³	1,000 ppm	500 ml/m ³
CO	5 ppm	≤ 10 mL/m ³	10 ppm	5 ml/m ³
H₂O	PDP: < -11 °C 1) H ₂ O: <35 mg/m ³ 2) H ₂ O: <25 mg/m ³	ADP: ≤ -45.6 °C	---	---
VOC (Oil Vapor)	0.5 mg/m ³	≤ 5.0 mg/m ³ (Oil mist and particle)	5 mg/m ³	1 mg/m ³
Odor	no	no	no	no

Dimensions

Due to the small dimensions of the robust and light carry case, the S605 can be easily transported anywhere.



Why is breathing air quality testing important?

- ✓ It protects the health, safety and well-being of your employees and people who are on your premises.
- ✓ It ensures that your compressor, products and personnel are protected from airborne volatile organic compounds (VOCs) as well
- ✓ It ensures that your business complies with national and international regulatory standards for breathing air quality.
- ✓ It ensures that your compressed air and work environment have safe levels of oxygen, lubricants, oil, odor, taste, carbon dioxide, carbon monoxide and water.

Technical Data

Measurement

Oxygen O₂

Accuracy	± 1 % of reading ± 0.05 %
Measuring range	0 ... 25 %
Resolution	0.1 %
Sensor	Optical oxygen sensor

Carbon Dioxide CO₂

Accuracy	± 1 % of reading ± 25 ppm
Measuring range	0 ... 1000 ppm
Resolution	1 ppm
Sensor	NDIR sensor

Carbon Monoxide CO

Accuracy	± 5 % of reading ± 1 ppm
Measuring range	0 ... 20 ppm
Resolution	0.1 ppm
Sensor	Electrochemical sensor

Humidity H₂O

Accuracy	±2 °C Td
Measuring range	-100 ... +20 °C Td / 0 ... 17458.6 mg/m ³
Resolution	0.1 °C Td
Sensor	QCM + Polymer

Oil Vapor

Accuracy	5 % of reading ± 0.003 mg/m ³
Measuring range	0.001 ... 5.000 mg/m ³ (Based on 1000 hPa(a), 20 °C, 0 % relative humidity)
Resolution	0.001 mg/m ³
Sensor	Photo ionization detector

Oil Mist and Particle

Accuracy	15 % of reading ± 0.1 mg/m ³
Measuring range	0.0 ... 5.0 mg/m ³ (Based on 1000 hPa(a), 20 °C, 0 % relative humidity)
Resolution	0.1 mg/m ³
Sensor	Oil mist and particle sensor

Pressure

Accuracy	0.5 % FS
Measuring range	0 ... 16 bar(g)
Resolution	0.01 bar
Sensor	Piezo resistive pressure sensor

Signal / Interface & Supply

Fieldbus

Protocol	Modbus/RTU (RS485) Modbus/TCP (Ethernet)
Update rate	1 / sec.

Power supply

Voltage supply	18-32 VDC, 20 W Battery
Current consumption	1.4 A

Interface

USB	USB Micro with OTG support
4G/LTE USB	USB Port for 4G/LTE Modem

General data

Configuration

Others	Device comes pre-configured Configuration can be done via on-screen touch
--------	---

Display

Integrated	5" color touch screen
------------	-----------------------

Data Logger

Storage	Up to 3 million recorded data sets (10 channels each)
Report	Integrated report generator for PDF export

Material

Process connection	6 mm quick connector
Housing	PC, Al alloy

Miscellaneous

Electrical connection	M12, USB-C, RJ45
Protection class	IP54
Water Inlet	6 mm connector
Dimensions	470 x 365 x 181 mm
Weight	11 kg

Approvals

EMC	FCC, CE
-----	---------

Operating conditions

Measuring Medium	Compressed breathing air
Sample Flow Rate	6 LPM@4 MPa(g), depends on input pressure
Sample rate	1 sample/sec
Medium temperature	0 ... +45 °C
Medium humidity	Medium humidity < 40 % rH, no condensation
Inlet Pressure	0.4 ... 1.5 MPa(g), External pressure reducer allow up to 35 MPa process pressure
Ambient temperature	0 ... +50 °C
Ambient humidity	0 ... 90 % rH
Storage temperature	-10 ... +50 °C
Transport temperature	-10 ... +50 °C

Ordering

Please use the following tables to assist in placing your order with our sales staff.

S605 Portable Breathing Air Quality Analyzer

Order No.	Description
P560 0605	S605 Portable Breathing Air Quality Analyzer, touch screen interface, data logger, guided measurement, PDF report generator (with oil vapor sensor refer to Europe, USA, Canada standards) *
P560 1605	S605 Portable Breathing Air Quality Analyzer, touch screen interface, data logger, guided measurement, PDF report generator (with oil mist and particle sensor refer to China standards)*
A1670	USB 4G dongle, including S4A software

* Including:

- Hand carry case with handle and shoulder belt
- USB OTG memory stick
- Purge filter for pre-measurement (test kit)
- Power adapter with USB type-C connector and cable included 60 W 20 V/3.25 A
- Connection hose 1.5 m, one end quick coupling, one end compressed air coupling
- M12 connector
- Filling bottle
- Certificate of calibration
- Operation and instruction manual

Accessories

Order No.	Description
A554 0602	Purity test kit consisting of zero filters for oil vapor, particles, and a desiccant cartridge for low dew point creation
A554 1203	Oil vapor zero filter, 1.5 MPa max, with quick connectors at both ends
A554 1204	Particle zero filter, 1.5 MPa max, with quick connectors at both ends
A554 1205	Dew point test kit for low dew point generation, with quick connectors at both sides
A604 0004	Pressure reducer, inlet pressure 0-30 MPa, outlet pressure 0.6 MPa
A604 0005	Pressure reducer, inlet pressure 0-40 MPa, outlet pressure 0.6 MPa

Service and Calibration

Order No.	Description
R200 0605	S605 General service and re-calibration <ul style="list-style-type: none"> • General inspection of the unit • Replacement of tubes and fittings • Cleaning of components • Calibration O₂, CO₂, CO, dew point sensor and oil vapor • Assembly and test of unit • Calibration Certificate

Exchange sensors

R200 0620	CO exchange sensor unit S605/S606
R200 0621	CO ₂ exchange sensor unit S605/S606
R200 0622	O ₂ exchange sensor unit S605/S606
R200 0623	Oil mist and particle sensor exchange unit S605/S606
R200 0624	Oil vapor sensor exchange unit S605/S606
R200 0625	Dew Point sensor exchange unit S605/S606

S606

Stationary Breathing Air Quality Analyzer



Coming Soon!



ALL IN ONE
O₂, CO₂, CO,
Dew Point,
Oil Vapor, Pressure



RELIABLE WARNING
Alarms can be programmed



EASY HANDLING
Clear and user friendly user guidance



HIGH PRECISION
Accurate measurements



ROBUST DESIGN
Suitable for harsh industrial condition



COMMUNICATION INTERFACE
Modbus TCP/RTU,
4G-Modem

Benefits

- ✓ All-in-one Instrument measures O₂, CO₂, CO, Dew Point and Oil Vapor simultaneously in the breathing air
- ✓ 24/7 permanent breathing air monitoring with programmable alarm settings
- ✓ Testing quality of breathing air according to national and international standards
- ✓ Compressed air connection via 6 mm tube
- ✓ Only one gas inlet for all parameters
- ✓ Integrated data logger saves data for later analysis

Contant breathing air quality monitoring

When it comes to breathing air, the health and safety of humans has highest priority. Still fatal accidents have occurred in the past due to the contaminated air.

To ensure the highest safety when breathing air is supplied, an online measurement system is required. Traditional breathing air analyzes have been carried out, by taking samples and later analyze them in an external laboratories. Online systems have been rarely available and often did come with very high investments and intense process modifications.

SUTO is here to change that. The S606 Breathing Air Quality Analyzer combines latest sensor technology into a single Plug & Play measurement solution.

S606 constantly measures O₂, CO₂, CO, Dew Point, Oil Vapor and Pressure as defined in the breathing air purity standards and notifies users in real-time when the purity is not within the defined limits.

It is smarter, faster and more convenient than the traditional methods.

Monitoring of all breathing air parameters

O₂	Oxygen	CO	Carbon Monoxide
CO₂	Carbon Dioxide	H₂O	Humidity
According to all relevant national and international standards		OIL	Oil Residues

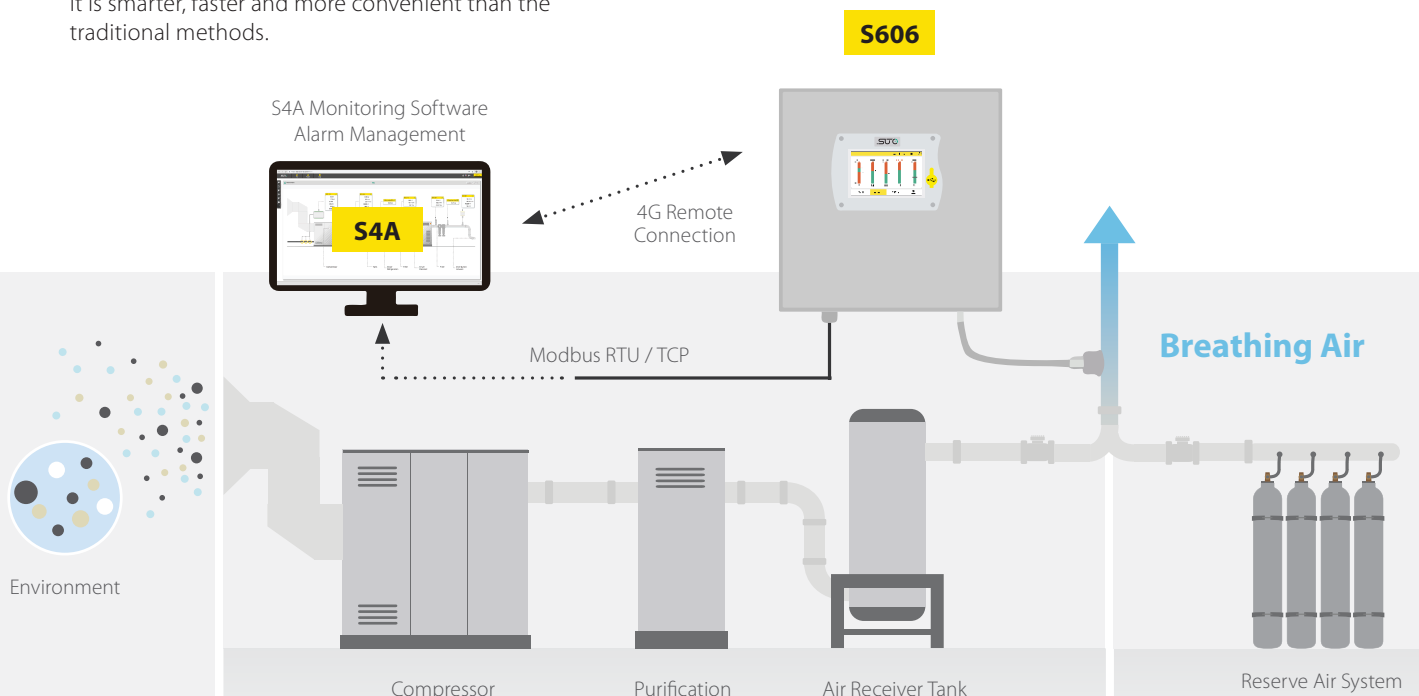



Applications

The S606 is a compact wall-mounted breathing air quality analyzer which measures all crucial breathing air parameters, to ensure that the breathing air is safe for health and the process.

Crucial Industries and Sectors rely on a reliable breathing air supply, e.g. fire fighting, diving, spray painting, chemical industry, offshore and high tech applications.

7 in 1 Measurement Device

O₂

Oxygen Measurement

For safety reasons, it is recommended to measure the oxygen level in the breathing air. The optical oxygen sensor monitors the O₂ content and indicates deviations from the standard concentration.

CO

Carbon Monoxide Measurement

The compressor intake air may be contaminated with CO due to nearby combustion engines or heating systems. Carbon monoxide is a toxic and life-threatening gas which will be monitored accurately by an electrochemical sensor.

OIL

Oil Vapor Measurement

Atmospheric oil vapor contained in industrial air environment can get into the system through the compressor intake. Compressed into the breathing air, the oil contaminants can cause health issues. The state-of-the-art sensor technology detects the oil contaminants immediately.



Pressure Measurement

The pressure sensor provides additional pressure data about the compressed air system using state of the art sensor technology.



Integrated Data Logger

The integrated data logger records all channels in parallel for later analysis. The 5" touchscreen allows you to interact with the device on site. There is no need for a PC to manage the device.

CO₂

Carbon Dioxide Measurement

The intake air may also be exposed to increased concentration of carbon dioxide. Filter material used in compressed air can adsorb, but also release CO₂. The gas is measured by the NDIR sensor to avoid extreme concentrations above 1000 ppm.

H₂O

Humidity Measurement

High humidity can cause corrosion and in severe cases lead to bursting air containers. In cold environment, it can freeze and block the air supply. The integrated dew point sensor is crucial to check the proper water removal of the dryers and filters.

Remote Connection

By connecting a 4G/LTE modem to the designated M12 port, S606 can be monitored remotely through S4A software.



Relevant standards for breathing air

Relevant standards including BS EN 12021, DEF STAN 68-284, OSHA, CSA and BS 8478 require adherence to specific limits of constituents in breathing air. Here some examples of the required for industrial breathing air:

Contaminant	Europe	China	USA	Canada
Standard	EN 12021	GB/T 31975-2015	CFSR	CSA
O₂	20 - 22 %	19.5 - 23.5 %	19.5 - 23.5 %	20 - 22 %
CO₂	500 ppm	≤ 1000 mL/m ³	1,000 ppm	500 ml/m ³
CO	5 ppm	≤ 10 mL/m ³	10 ppm	5 ml/m ³
H₂O	PDP: < -11 °C 1) H ₂ O: <35 mg/m ³ 2) H ₂ O: <25 mg/m ³	ADP: ≤ -45.6 °C	---	---
VOC (Oil Vapor)	0.5 mg/m ³	≤ 5.0 mg/m ³ (Oil mist and particle)	5 mg/m ³	1 mg/m ³
Odor	no	no	no	no

Why is breathing air quality testing and monitoring important?

- ✔ It protects the health, safety and well-being of your employees and people who are on your premises.
- ✔ It ensures that your compressor, products and personnel are protected from airborne volatile organic compounds (VOCs) as well
- ✔ It ensures that your business complies with national and international regulatory standards for breathing air quality.
- ✔ It ensures that your compressed air and work environment have safe levels of oxygen, lubricants, oil, odor, taste, carbon dioxide, carbon monoxide and water.

Dimensions

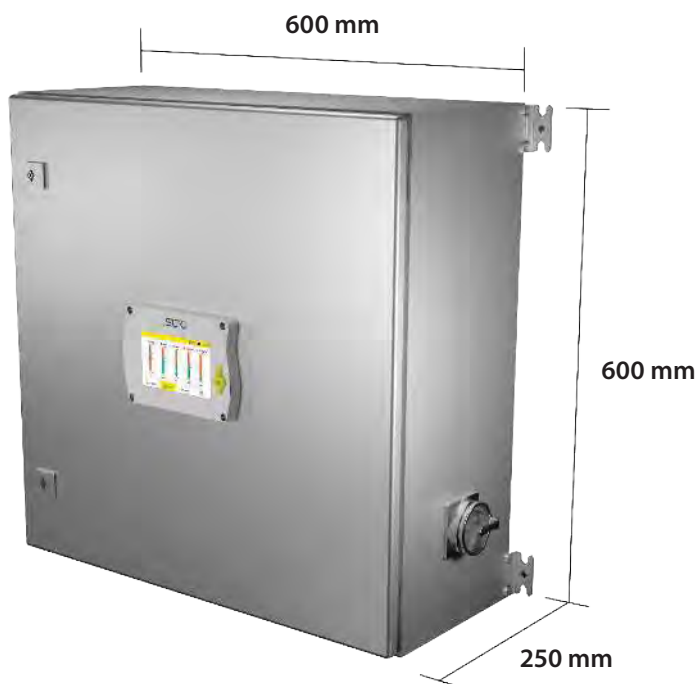

Technical Data

Measurement

Oxygen O₂

Accuracy	± 1 % of reading ± 0.05 %
Measuring range	0 ... 25 %
Resolution	0.1 %
Sensor	Optical oxygen sensor

Carbon Dioxide CO₂

Accuracy	± 1 % of reading ± 25 ppm
Measuring range	0 ... 1000 ppm
Resolution	1 ppm
Sensor	NDIR sensor

Carbon Monoxide CO

Accuracy	± 5 % of reading ± 1 ppm
Measuring range	0 ... 20 ppm
Resolution	0.1 ppm
Sensor	Electrochemical sensor

Humidity H₂O

Accuracy	± 2 °C Td
Measuring range	-100 ... +20 °C Td / 0 ... 17458.6 mg/m ³
Resolution	0.1 °C Td
Sensor	QCM + Polymer

Oil Vapor

Accuracy	5 % of reading ± 0.003 mg/m ³
Measuring range	0.001 ... 5.000 mg/m ³ (Based on 1000 hPa(a), 20 °C, 0 % relative humidity)
Resolution	0.001 mg/m ³
Sensor	Photo ionization detector

Oil Mist and Particle

Accuracy	15 % of reading ± 0.1 mg/m ³
Measuring range	0.0 ... 5.0 mg/m ³ (Based on 1000 hPa(a), 20 °C, 0 % relative humidity)
Resolution	0.1 mg/m ³
Sensor	Oil mist and particle sensor

Pressure

Accuracy	0.5 % FS
Measuring range	0 ... 16 bar(g)
Resolution	0.01 bar
Sensor	Piezoresistive pressure sensor

Signal / Interface & Supply

Fieldbus

Protocol	Modbus/RTU (RS485) Modbus/TCP (Ethernet)
----------	---

Power supply

Voltage supply	100 ... 240 VAC, 50/60 Hz, 50 VA
----------------	----------------------------------

Interface

USB	USB Micro with OTG support
M12	4G/LTE Modem

General data

Configuration

Others	Device comes pre-configured Configuration can be done via on-screen touch
--------	---

Display

Integrated	5" color touch screen
------------	-----------------------

Data Logger

Storage	Up to 3 million recorded data sets (10 channels each)
Report	Integrated report generator for PDF export

Material

Process connection	6 mm quick connector
Housing	Sheet steel, powder-coated on the outside (Stainless steel on request)

Miscellaneous

Electrical connection	M12, PG plug, RJ45
Protection class	IP54
Water Inlet	G1 connector
Water Outlet	G1/8 connector
Dimensions	600 x 600 x 250 mm
Weight	34 kg

Approvals

EMC	FCC, CE
-----	---------

Operating conditions

Measuring Medium	Compressed breathing air
Sample Flow Rate	6 LPM@4 MPa(g), depends on input pressure
Sample rate	1 sample/sec
Medium temperature	0 ... +45 °C
Medium humidity	Medium humidity < 40 % rH, no condensation
Inlet Pressure	0.4 ... 1.5 MPa(g), External pressure reducer allow up to 35 MPa process pressure
Ambient temperature	0 ... +50 °C
Ambient humidity	0 ... 90 % rH
Storage temperature	-10 ... +50 °C
Transport temperature	-10 ... +50 °C

Ordering

Please use the following tables to assist in placing your order with our sales staff.

S606 Stationary Breathing Air Quality Analyzer

Order No.	Description
D500 0606	S606 Stationary Breathing Air Quality Analyzer, touch screen interface, data logger, metal cabinet for wall mounting (with oil vapor sensor refer to Europe, USA, Canada standards)*
D500 1606	S606 Stationary Breathing Air Quality Analyzer, touch screen interface, data logger, metal cabinet for wall mounting (with oil mist and particle sensor refer to China standards)*
A1670	USB 4G dongle, including S4A software
A554 0131	4G USB Dongle protection case, with extension cable 2 m and M12 Connector
A1510	Relay module for S606, 8-ch Relay Output
	* Including: <ul style="list-style-type: none"> • USB OTG memory stick • Purge filter for pre-measurement (test kit) • Connection hose 1.5 m, one end quick coupling, one end compressed air coupling • M12 connector • Certificate of calibration • Operation and instruction manual

Accessories

Order No.	Description
A554 0602	Purity test kit consisting of zero filters for oil vapor, particles, and a desiccant cartridge for low dew point creation
A554 1203	Oil vapor zero filter, 1.5 MPa max, with quick connectors at both ends
A554 1204	Particle zero filter, 1.5 MPa max, with quick connectors at both ends
A554 1205	Dew point test kit for low dew point generation, with quick connectors at both sides
A604 0004	Pressure reducer, inlet pressure 0-30 MPa, outlet pressure 0.6 Mpa
A604 0005	Pressure reducer, inlet pressure 0-40 MPa, outlet pressure 0.6 Mpa

Service and Calibration

Order No.	Description
R200 0605	S606 General service and re-calibration <ul style="list-style-type: none"> • General inspection of the unit • Replacement of tubes and fittings • Cleaning of components • Calibration O₂, CO₂, CO, dew point sensor and oil vapor • Assembly and test of unit • Calibration Certificate

Exchange sensors

R200 0620	CO exchange sensor unit S605/S606
R200 0621	CO ₂ exchange sensor unit S605/S606
R200 0622	O ₂ exchange sensor unit S605/S606
R200 0623	Oil mist and particle sensor exchange unit S605/S606
R200 0624	Oil vapor sensor exchange unit S605/S606
R200 0625	Dew Point sensor exchange unit S605/S606

S530

Ultrasonic Leak Detector

Eco Version



EASY TO USE
Find leaks in minutes



LASER POINTER
To spot the leak



COMPACT DESIGN
Can be used anywhere



NOISE ISOLATED HEADSET
Inaudible signals easily to be heard



LONG BATTERY LIFE



Operation Principle

When gases are leaking through tubes and tanks, an ultrasonic sound is produced which can be detected by the S530 even from several meters away. The S530 transforms these inaudible signals into a frequency which can be easily heard by using the supplied noise isolated headset.

The integrated laser pointer helps to spot the leak from distance. In unpressurized systems, an ultrasonic tone generator can be used whose sound will leak through small openings.

Save Your Time and Costs

Leaks in compressed air systems can significantly increase the cost of compressed air.

The detection of leaks is an important maintenance requirement, which can be done by soapy water or in a more convenient way with ultrasonic leak detectors like S530.

The S530 Leak Detector is providing an easy-to-use and cost-efficient solution to detect leaks in compressed air and gas systems.

Applications

- Leak detection in compressed air, refrigerants, simply of any gas!
- Insulation test of doors and windows
- Detection of partial electrical discharges causing damages on insulations

Easy to use



Leak Detection



Point with the laser at an assumed leak. The display will show the level of the leak.



Detection at medium distance for locating the leakage area.



Scan with the focus tube and focus tip the roughly location till the exact location is found.

Technical Data

Measurement

Flow

Sensor	Ultrasonic leak detection sensor
Laser	640 ... 660 nm wavelength 0.4 ... 0.5 mW output power

Supply

Power supply	Internal NiMH rechargeable battery
Operating time	6h

Headset

Headset	Noise isolated head set
Headset connection	3.5 mm stereo phone jack

General data

Display

Integrated	3 colour black-mask LCD, 10 level
------------	-----------------------------------

Material

Housing	PC + ABS
---------	----------

Miscellaneous

Protection class	IP30
Approvals	CE
Weight	2.5 kg for the full set

Operating conditions

Medium	Compressed Air, refrigerants and any compressed gases
Ambient temperature	0 ... +40 °C
Ambient humidity	< 90 % rH
Storage temperature	-10 ... +50 °C
Transport temperature	-20 ... +50 °C



Cost Saving

Compressed air is one of the most expensive energy forms. In Germany alone, 60,000 pneumatic systems consume 14,000,000,000 kWh electricity every year. 15 % to 20 % of this could easily be saved (Peter Radgen, Fraunhofer Institute, Karlsruhe). A large portion of these costs are caused by leaks in compressed air systems, allowing the air to "escape" unused.

Calculation example at 0.6 MPa:

1 hole of 1mm diameter = 270 EUR/year

Option

Ultrasonic tone generator to be used in pressure less systems. The generator emits ultrasonic waves which can be detected by the S530.

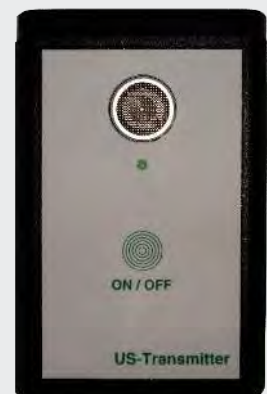

Ordering

Please use the following tables to assist in placing your order with our sales staff.

S530 Ultrasonic Leak Detector

Order No.	Description
-----------	-------------

P601 0103	S530 Ultrasonic Leak Detector set
-----------	-----------------------------------

Including:

P560 0102	S530 Ultrasonic Leak Detector
-----------	-------------------------------

S605 0001	Sensor unit
-----------	-------------

A554 0114	Noise isolated headset
-----------	------------------------

A530 0101	Focus tube and focus tip
-----------	--------------------------

A554 0001	Battery charger
-----------	-----------------

A554 0101	Transport case S530
-----------	---------------------

Accessories

Order No.	Description
-----------	-------------

A554 0103	Ultrasonic tone generator
-----------	---------------------------

Contents of Set

Head set



Charger



Focus tip



Focus tube



S530



S531

Smart Ultrasonic Leak Detector

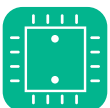

MASS STORAGE
Almost unlimited memory for leak records, photos and voice recording



DETECT FROM DISTANCE
Finds leaks in compressed air system easily even from distance



WIRELESS CONNECTION
Wireless connection to headset



ANALYSIS
Export data to LMS for statistics and repair



PHOTOGRAPH LEAK PARTS
Build in camera to take photo of leak locations

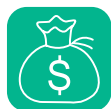

LOSS CALCULATE
Calculates air loss in m³/h or in local currency



VOICE RECORDING
Voice recorder for voice memos



NOISE REDUCTION
Integrated noise reduction



LASER
Pinpoint locations with laser pointer



LONG WORKING HOURS
Battery capacity for up to 6 hours



Benefits

- ✔ Finds leaks in compressed air system easily even from distance
- ✔ Full support for Leak Surveys with the SUTO Leak Management Software (LMS)
- ✔ The perfect tool for professional leak detection
- ✔ Fast return on investment
- ✔ Easy to use, but powerful in performance

Detect and manage your compressed air leaks — save your time and costs

Finding leaks in the compressed air system is the first step into energy saving. The leaking compressed air causes immense electrical costs, as your compressors are running more than they would actually need to run.

S531 is a smart ultrasonic leak detector that helps users quickly find and record leakages in compressed air or any gas systems. The built-in touch screen assists the user easy operation in leak detecting. Photographing and voice recording make leak surveys more flexible and efficient.

S531 is designed to work with SUTO Leak Management Software (LMS) to enable companies to properly manage their leakage detection and repair activities.

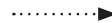

Leak Management Software (LMS)

LMS included for free

When purchasing a S531 set, one free LMS license is included. Start immediately creating powerful leak reports, without paying extra for additional software licenses.

Leak Detection



Point with the laser at an assumed leak. The display will show the level of the leak.



Detection at medium distance for locating the leakage area. Record the leak losses at closer distance.



If needed, scan with the focus tube and focus tip till the exact location is found.

Seamless Connection with Leak Management Software (LMS)



Cost Saving

Compressed air is one of the most expensive energy forms. In Germany alone, 60,000 pneumatic systems consume 14,000,000,000 kWh electricity every year. 15 % to 20 % of this could easily be saved (Peter Radgen, Fraunhofer Institute, Karlsruhe). A large portion of these costs are caused by leaks in compressed air systems, allowing the air to "escape" unused.

Calculation example at 0.6 MPa:

1 hole of 1mm diameter = 270 EUR/year

Option

Ultrasonic tone generator to be used in pressure less systems. The generator emits ultrasonic waves which can be detected by the S530.

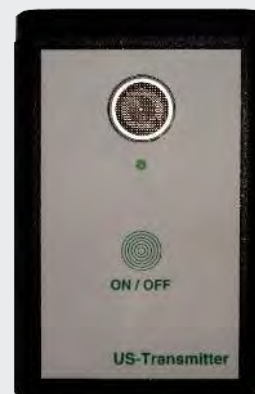

Technical Data

Measurement

Selectable units	l/min, m ³ /h, cfm, bar, MPa, psi
Sensor	Ultrasonic leak detection sensor
Laser	Wave length: 640 ... 660 nm Output power: < 1.0 mW
Camera	5.0 mega pixels

Interface & Supply

Supply

Power supply	Internal Lithium-Ion battery
Operating time	6 h

Data interface

Connection	USB port for charging and data exchange
------------	---

Headset

Headset	Noise isolated headset
Headset connection	Wireless and 3.5 mm stereo phone jack for headset

General data

Display

Integrated	3.5" color LCD touch screen
------------	-----------------------------

Data Logger

Storage	Integrated mass storage, up to 500 records for voice recordings and pictures
---------	--

Material

Housing	PC + ABS
---------	----------

Miscellaneous

Protection class	IP30
Approvals	CE
Weight	430 g for the leak detector 3,65 kg for the full set

Operating conditions

Medium	Compressed Air, refrigerants and any compressed gases
Ambient temperature	0 ... +40 °C
Ambient humidity	<90 % rH
Storage temperature	-10 ... +50 °C
Transport temperature	-20 ... +50 °C



Ordering

Please use the following tables to assist in placing your order with our sales staff.

S531 Smart Ultrasonic Leak Detector

Order No.	Description
-----------	-------------

P601 0104	S531 Smart Ultrasonic Leak Detector Set <u>Including:</u>
P560 0104	S531 Smart Ultrasonic Leak Detector
A554 0119	Noise isolate/canceling headset, wireless
A530 0101	Focus tube and focus tip for accurately pinpointing
A554 0123	Trumpet for locating leaks over longer distances
A554 0117	Battery charger
A554 0118	Transport case S531
A554 0122	Leak tags to mark found leaks, 100 pieces
M599 7045	LMS Leak Management Software, Local Installation, 1 License (bound to local PC), no subscription, one-time payment

Accessories

Order No.	Description
-----------	-------------

A554 0103	Ultrasonic tone generator
R200 0070	Calibration S531

Scope of delivery

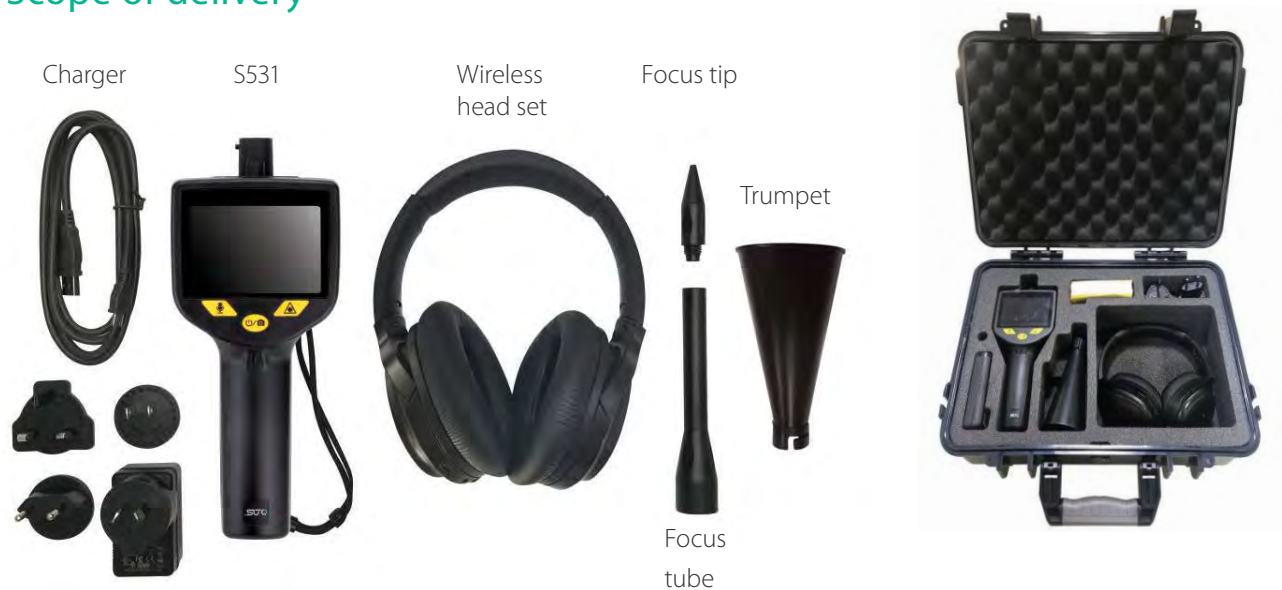

LMS

Leak Management Software

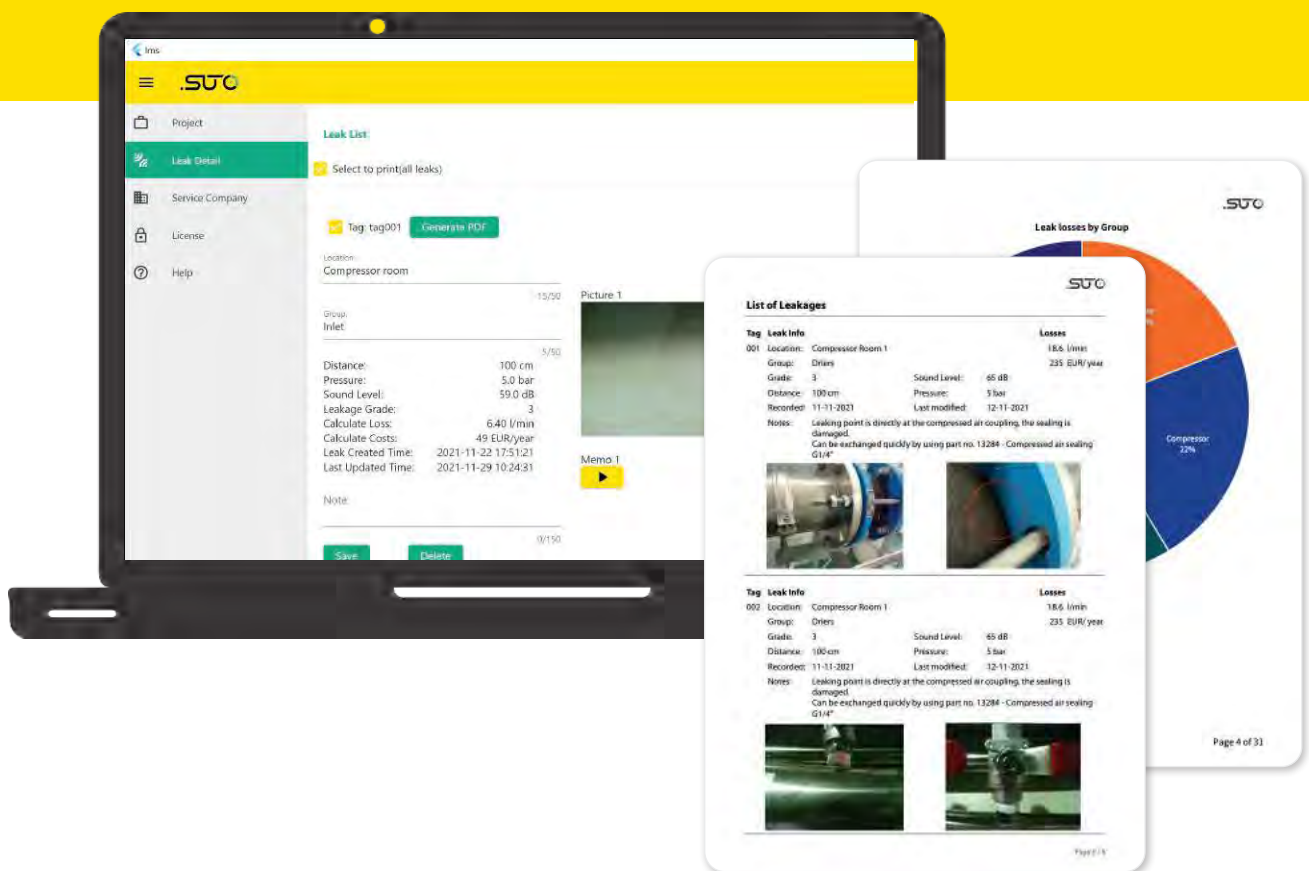

Manage your compressed air leaks —
save your time and costs

The Leak Management Software (LMS) provides a total solution for leak detection, management and easy report creation. The software comes as a local installation on a PC and works seamlessly with our S531 ultrasonic leak detector. Recording leaks in the field using SUTO S531 leak detector and later importing them to LMS software enables users to gather quantitative leak loss data and easily create powerful reports which provide a full overview of the customers' leak situation.



Benefits

- ✔ Simple and user-friendly user interface for easy navigation and leak survey handling
- ✔ Reports can be personalized with your own company logo and contact information
- ✔ Save your valuable time in report documentation by having a one-click report
- ✔ Adjust your reports to local specifications by using the integrated unit converter

Convenient User Experience

- FLAT INTERACTION DESIGN**
Simplify the operation steps
- LOCAL INSTALLATION**
Easy to install and save your data locally
- ONE-CLICK IMPORT AND UPDATE**
Import and update new leak data just by a simply click

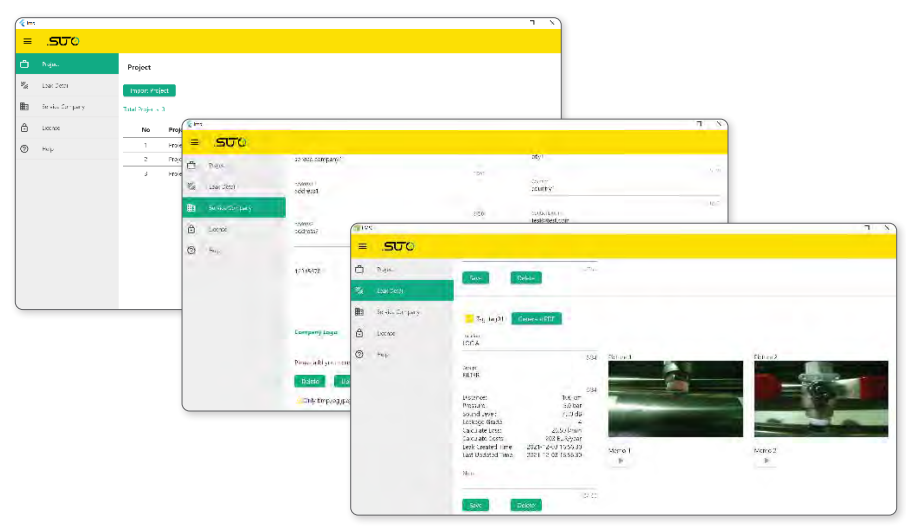

Powerful Analysis Reports

- EXTENSIVE ANALYSIS REPORT**
Leak report with all relevant data
- PERSONALIZED CONFIGURATION**
Upload your company logo, contact person etc.
- PRINT CONTENT OPTIONAL**
Select your desired leaks to be printed



Seamless Connection with S531



Included in S531 for free

When purchasing a S531 ultrasonic leak detector set, one free LMS license is included. Start immediately creating powerful leak reports, without paying extra for additional software licenses.

Ordering

Leak Management Software (LMS)

Order No.	Description
M599 7045	Leak Management Software (LMS), Local installation, 1 license (bound to local PC)*, one-time payment

* The software license is bound to the local PC, still the same software can be used by multiple users on the same PC.



sales@suto-itec.com

Trial Period

Test it for 30 Days!

If you want to try LMS we are offering a 30 days trial period with full functionality.

When the 30 days are due to expire, in order to continue using the software you need to buy a license.



www.suto-itec.com

S110

Power and Energy Meter



S110



S110-P



**MULTIFUNCTION
 POWER AND
 ENERGY METER**
 3-phase, 1-phase



**COMPRESSOR
 PERFORMANCE**
 Helps to identify
 compressor efficiency

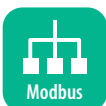

**MODBUS/
 RTU INTERFACE**
 Connects to any
 Modbus-Master



**ROGOWSKI
 COILS**
 Wide range,
 highly accurate

Benefits

- ✓ Convenient and easy to set up compressor performance and efficiency monitoring
- ✓ Real power consumption in kW and kWh by measuring each phase voltage and current
- ✓ DIN rail installation for power cabinets or portable version with rugged housing
- ✓ Power range up to 2 MW (2000 kW)
- ✓ Three current sensor models with 100 A, 1000 A or 3000 A available



Operation Principle

The SUTO Power and Energy Meter has been designed with a focus on easy installation and reliable measurements. The main application is to measure the power consumption and the accumulated energy consumption of electrical 3-phase consumers, like compressors, driers and oxygen/nitrogen generators.

The main difference to common power measurements is that all relevant parameters are real measured values and not assumptions. Unlike the traditional method, where only one phase is measured, the voltage is assumed as stable and the phase shift is entered as a constant, the S110 measures the voltage and current of each phase.

By this, the S110 is much more accurate and delivers more reliable measurements compared to single phase current measurements.

S110



Application

In this illustration, a Power and Energy Meter is installed directly into the connection box of the compressor.

The Rogowski current coils are easy to install, by just clamping them around the power cables. The voltage connection can be drawn directly from the power cabinet of the compressor.

The Power and Energy Meter is then connected to a S330 / S331 Display and Data Logger to record the Voltage and Current of each phase, as well as recording the actual power consumption and the total energy consumption.

This is not only used to identify inefficient compressors, but also letting the compressed air operator know what the real costs of the compressed air are.

S110

Power and Energy Meter

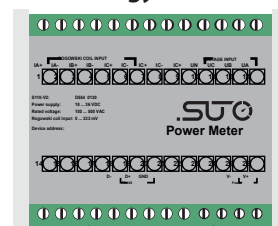

S331

Data Logger

S330 / S331 can be used as stationary display of up to 16 power meters

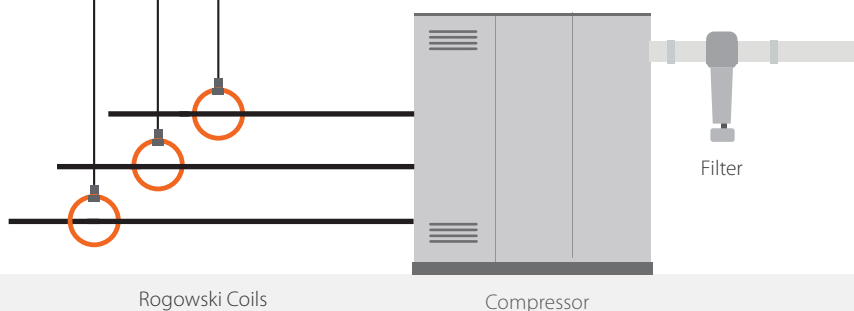
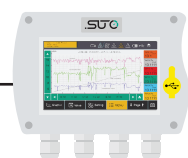

Rogowski Coils

Compressor

Filter



Current Measuring via Rogowski coils offers a high accuracy over a wide range and an easy installation. (Note: for each phase, one coil is needed)



S110-P



Monitoring Software



Wireless Connection

S551

Portable Data Logger

Can be used as onsite portable display

Compressor Efficiency Test

Knowing your compressor efficiency is the first step for your energy saving goals. With this solution you will know, how much electrical energy is needed to produce 1 m³ compressed air and what are the electrical costs.

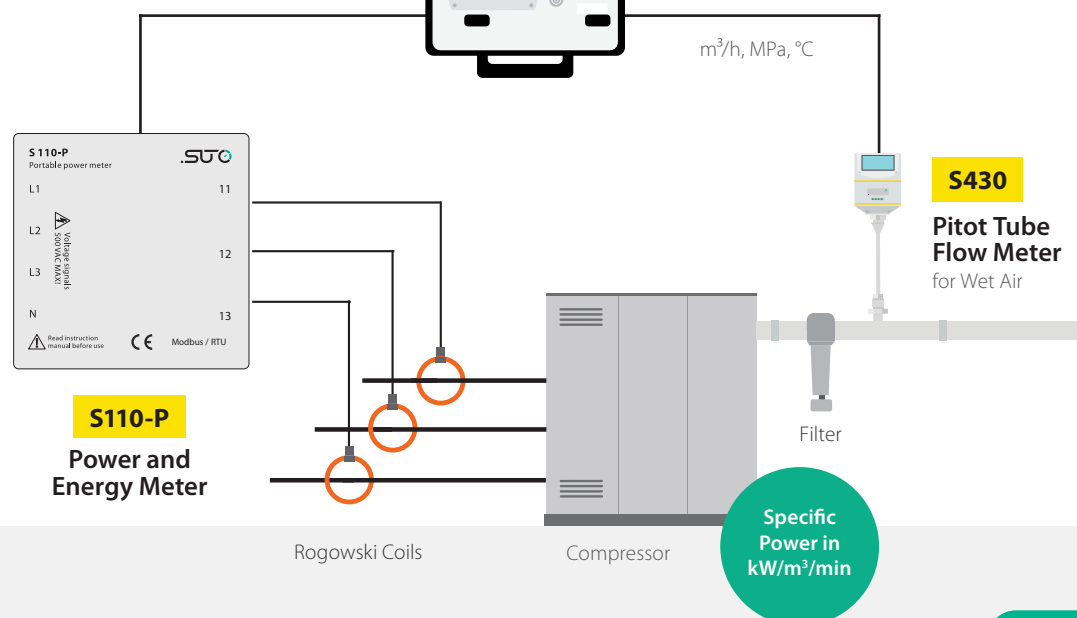

Technical Data

Measurement

Flow

Accuracy	V = 0.2 %, A = 0.5 %
Selectable units	V, A, kW, kvar, kVA, kWh, Hz
Measuring range	100 ... 500 VAC, up to 2500 kW
Sampling rate	8 k/s

Signal / Interface & Supply

Fieldbus

Protocol	Modbus RTU
----------	------------

Supply

Voltage supply	24 VDC S110 1 W
	24 VDC S110-P 2 W

Current consumption	Max. 50 mA
---------------------	------------

Data interface

Connection	M12 connector
------------	---------------

General data

Material

Housing	ABS
---------	-----

Miscellaneous

Protection class	IP20
------------------	------

Approvals	CE
-----------	----

Weight	0.21 kg
--------	---------

Operating conditions

Ambient temperature	-25 ... +55 °C
---------------------	----------------

Storage temperature	-40 ... +85 °C
---------------------	----------------

Ordering

Please use the following tables to assist in placing your order with our sales staff.

S110 Power and Energy Meter

Order No. Description

Stationary

D554 0130	S110 Power and Energy Meter, hat rail, Modbus/RTU, 24 VDC supply
S554 0140	Electrical Current Transmitter for S110, 1000 A, 100 mm diameter, 1.8 m cable, open ends
S554 0141	Electrical Current Transmitter for S110, 3000 A, 150 mm diameter, 1.8 m cable, open ends
S554 0142	Electrical Current Transmitter for S110, 100 A, 16 mm diameter, 1.8 m cable, open ends

Portable

P554 0134	S110-P Portable Power and Energy Meter, incl. 5 m connection cable to S551 (Modbus/RTU), 4 voltage test leads and 4 test clips
S554 0160	Electrical Current Transmitter for S110-P, 1000 A, 100 mm diameter, 1.8 m cable, connector to S110-P
S554 0161	Electrical Current Transmitter for S110-P, 3000 A, 150 mm diameter, 1.8 m cable, connector to S110-P
S554 0162	Electrical Current Transmitter for S110-P, 100 A, 16 mm diameter, 1.8 m cable, connector to S110-P

S010 / S011

Pressure Transmitter

Seamless Integration into your Compressed Air System

Pressure is the key point in a compressed air system. This makes it crucial to keep the pressure at a constant and reliable level. Monitoring and measuring the compressed air pressure is needed to save energy, identify degrading at an early stage and keep production machinery running.

SUTO pressure transmitters are made to seamlessly integrate into your compressed air monitoring system and provide reliable measurement results.

Available in Three Ranges

- 0 ... 1.6 MPa(g)
- 0 ... 4.0 MPa(g)
- 0 ... 0.16 MPa(abs.)

Signal Output

The pressure sensor is offered as a 2-wire analog output version for easy connection.

For modern monitoring solutions, the Modbus/RTU version allows to easily connect multiple sensors to a single data logger.



S010

4 ... 20 mA

S011

Modbus/RTU

Benefits

- ✓ High accurate and affordable industrial pressure transmitter
- ✓ Excellent anti-interference capability (EMC, EMI)
- ✓ Salt-spray, temperature and humidity tested
- ✓ IP67 protection
- ✓ 4 ... 20 mA loop powered or Modbus/RTU output

Industrial equipment for manifold applications

- Hydraulic and pneumatic systems
- Industrial engines
- HVAC/R equipment
- Spraying systems
- Cooling systems

Technical Data

Measurement

Pressure	
Accuracy	±0.5 % F.S (optional ±0.25 % F.S)
Measuring range	0 ... 4.0 MPa
Response time (t90)	≤1 ms (@ 90 % F.S)

Signal / Interface & Supply

Analog output (for 4 ... 20 mA type)	
Signal	4 ... 20 mA, (2-wire loop powered)
Load	Max. 250 Ohm
Fieldbus (for Modbus/RTU type)	
Protocol	Modbus/RTU
BUS-Length	≤ 1000 m
Supply	
Voltage supply	11 ... 36 VDC
Current consumption	Max. 20 mA
Data interface	
Connection	M12 Connector

General data

Material	
Process connection	Stainless steel 1.4301
Housing	Stainless steel 1.4301
Metal parts	Stainless steel 1.4301
Miscellaneous	
Electrical connection	M12 Connector
Protection class	IP67
Approvals	CE
Process connection	G1/4" (ISO 228/1)
Operating conditions	
Medium temperature	-40 ... +85 °C
Ambient temperature	-40 ... +85 °C
Storage temperature	-40 ... +125 °C

Dimensions (4 ... 20 mA Type)

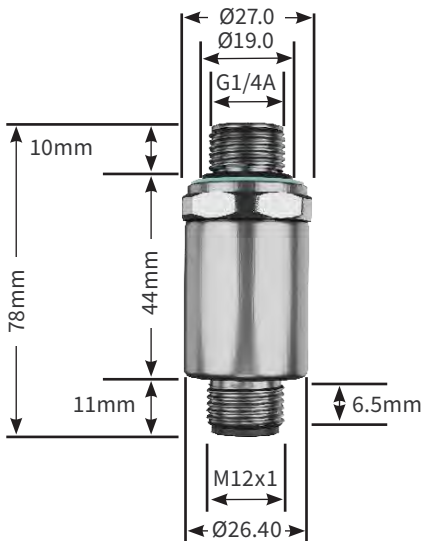

Dimensions (Modbus/RTU Type)

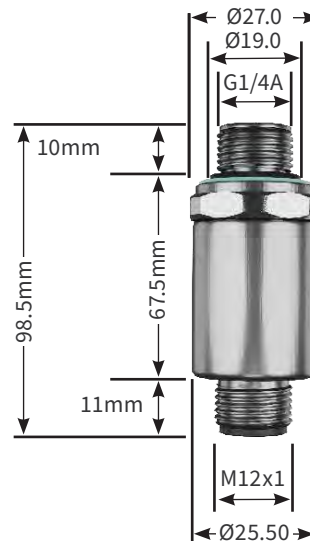

Ordering

Please use the following tables to assist in placing your order with our sales staff.

S010 Pressure Transmitter

Order No.	Description
S694 3557	Pressure Transmitter, 0 ... 1.6 MPa(g), 2-wire 4 ... 20 mA output, incl. M12 connector, G1/4" thread
S694 3558	Pressure Transmitter, 0 ... 4.0 MPa(g), 2-wire 4 ... 20 mA output, incl. M12 connector, G1/4" thread
S694 2564	Pressure Transmitter, 0 ... 0.16 MPa(a), 2-wire 4 ... 20 mA output, incl. M12 connector, G1/4" thread
A553 0104	Sensor cable 5 m, with M12 connector, open wires, AWG 24 (0.2 mm ²)
A553 0105	Sensor cable 10 m, with M12 connector, open wires, AWG 24 (0.2 mm ²)
R200 0030	Pressure Transmitter calibration at 3 points

S011 Pressure Transmitter

Order No.	Description
S694 2559	Pressure Transmitter, 0 ... 1.6 MPa(g), Modbus/RTU, incl. M12 connector, G1/4" thread
S694 2562	Pressure Transmitter, 0 ... 4.0 MPa(g), Modbus/RTU, incl. M12 connector, G1/4" thread
S694 2563	Pressure Transmitter, 0 ... 0.16 MPa(a), Modbus/RTU, incl. M12 connector, G1/4" thread
A553 0104	Sensor cable 5 m, with M12 connector, open wires, AWG 24 (0.2 mm ²)
A553 0105	Sensor cable 10 m, with M12 connector, open wires, AWG 24 (0.2 mm ²)
R200 0030	Pressure Transmitter calibration at 3 points

S020

Temperature Transmitter



Two Versions

The compact sensor solution with 4 ... 20 mA output available in 2 sizes

Industrial Equipment for Manifold Applications

The temperature transmitter is a sensor which is designed to measure the temperature of liquid, vapour, compressed air and gases within the permissible operating parameters.

- Measure the inlet / outlet temperature of dryers
- Measure the outlet temperature of compressors

Benefits

- ✓ High accurate and affordable industrial temperature sensor
- ✓ Easy installation in compressed air systems
- ✓ 4 ... 20 mA transmitter
- ✓ Wide range of -50... +250 °C

Compression Fitting



There are different types of compression fittings available:

- Compression fitting 6mm, G1/2", PTFE ring, 0.6 MPa
- Compression fitting 6mm, G1/2", metal ring, 1.6 MPa

Technical Data

Measurement

Temperature

Accuracy	0.5 % o.RGD + 0.2 % FS
Measuring range	-50 ... +200 °C
Sensor	PT100 Class A

Signal / Interface & Supply

Analog output

Signal	4 ... 20 mA, (2 wire loop powered)
Scaling	4 mA = -50 °C, 20 mA = +200 °C
Load	Max 250 Ohm

Supply

Voltage supply	16 ... 30 VDC
Current consumption	Max. 20 mA

Data interface

Connection	M12 connector
------------	---------------

General data

Material

Process connection	Stainless steel 1.4571
Housing	Stainless steel 1.4571
Metal parts	Stainless steel 1.4571

Miscellaneous

Electrical connection	M12 connector
Protection class	IP67
Approvals	CE
Process connection	6 mm Fitting
Weight	0.08 kg

Operating conditions

Ambient temperature	-40 ... +90 °C
---------------------	----------------

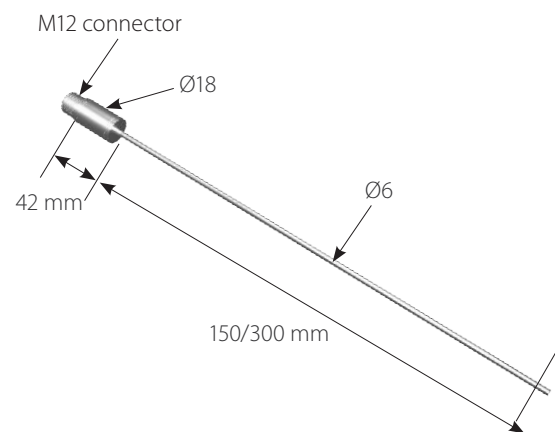

Ordering

Please use the following table to assist in placing your order with our sales staff.

S020 Temperature Transmitter

Order No.	Description
S693 0003	Temperature Transmitter, -50 ... +200 °C, 4 ... 20 mA loop powered, 6 x 150 mm sensor tube
S693 0004	Temperature Transmitter, -50 ... +200 °C, 4 ... 20 mA loop powered, 6 x 300 mm sensor tube
A554 6003	Compressor fitting 6 mm, G1/2", PTFE ring, 0.6 MPa
A554 6004	Compressor fitting 6 mm, G1/2", metal ring, 1.6 MPa
A553 0104	Sensor cable, 5 m with M 12 connector, open wires, AWG 24 (0.2 mm ²)

S030

Electrical Current Transmitter





Benefits

- ✔ Easy installation
- ✔ Wide measuring range
- ✔ Accurate current sensing
- ✔ 4 ... 20 mA output signal
- ✔ IP67 casing provides robust protection in the industrial environment

Accurate current measurement

SUTO current sensor is an AC RMS current sensor composed of a flexible active part (Rogowski coil model) connected to a compact digital converter, capable of measuring the current carried on a power conductor up to a value of 3000 A AC.

The digital converter supplies an output of 4 ... 20 mA DC in linear proportion to the measured current.

Current Transmitter Application

- Current sensing at compressors for load / unload analysis
- Current sensing for power / energy measurement
- Evaluation of machine operation hours

Position Sensitivity

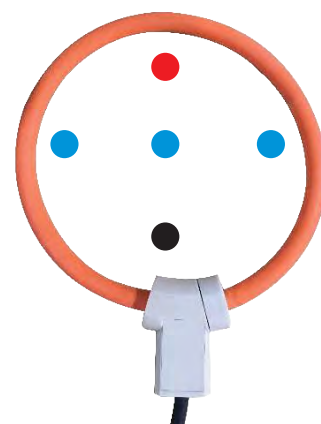

Conductor Position	Typical Error(%)
● (Red)	< 0.5 %
● (Blue)	< 0.8 %
● (Black)	< 1 %

Single Phase Power Measurements

By measuring the current of a symmetric power consumer on one phase, compressed air experts are able to calculate the power consumption of the compressors without the need of measuring voltage additionally.

This offers an analysis of the compressor and allows to judge the efficiency of the system.

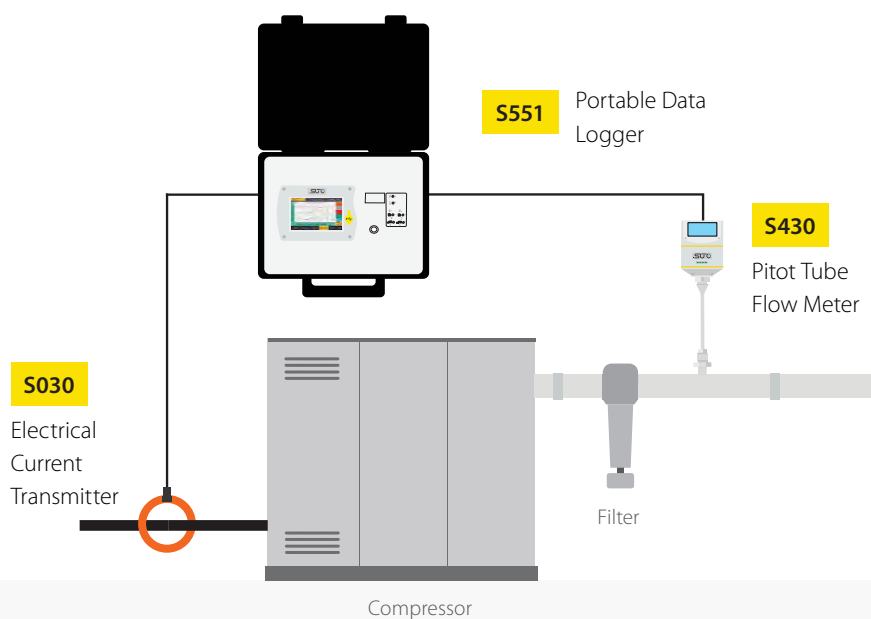

Technical Data

Measurement

Current

Accuracy 0,5 % of reading + 0,2 % of range

Signal / Interface & Supply

Analog output

Signal 4 ... 20 mA 3-wire
 Scaling 4 mA = 0A AC,
 20 mA = 1000A / 3000 A AC
 Load Max. 300 Ohm

Supply

Voltage supply 10 – 32 VDC
 Current consumption Max. 30 mA

Data interface

Connection open wire ends / ODU connector

General data

Miscellaneous

Protection class IP67

Approvals CE

Operating conditions

Ambient temperature 0 ... +80 °C

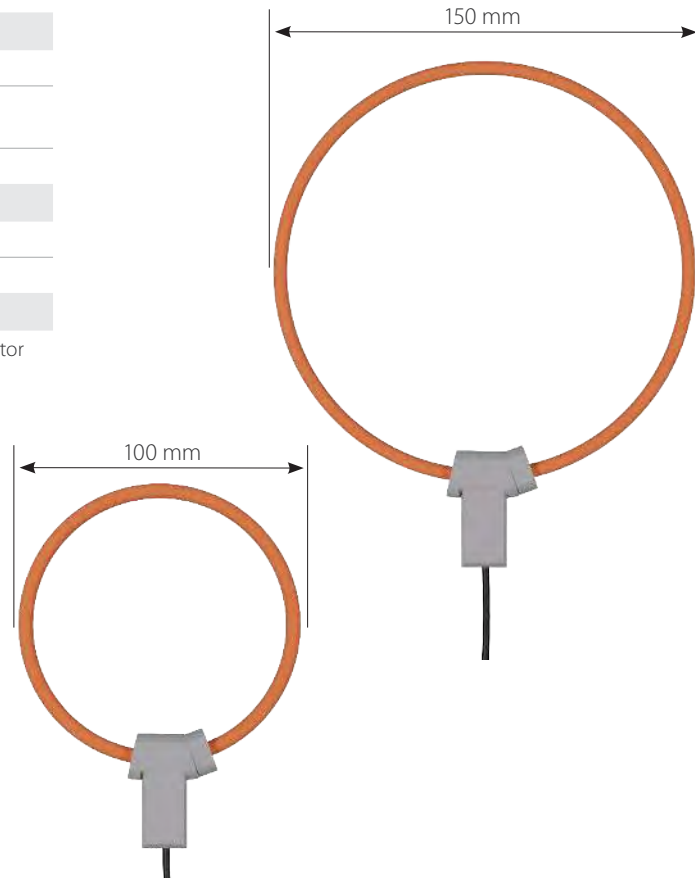

Ordering

Please use the following table to assist in placing your order with our sales staff.

S030 Electrical Current Transmitter

Order No.	Description
S554 0155	Electrical Current Transmitter, 1000 A, 100 mm diameter, open wire ends
S554 0156	Electrical Current Transmitter, 1000 A, 100 mm diameter, including connector to S551
S554 0157	Electrical Current Transmitter, 3000 A, 150 mm diameter, including connector to S551
S554 0158	Electrical Current Transmitter, 3000 A, 150 mm diameter, open wire ends

Calibration and Certification

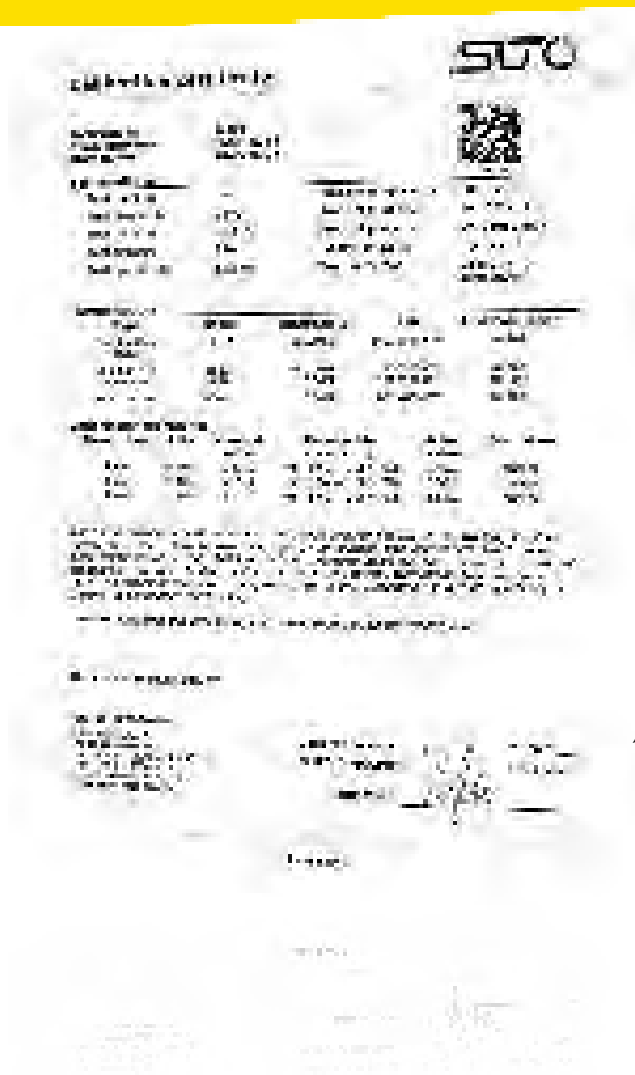

FLOW CALIBRATION



PARTICLE CALIBRATION



OIL VAPOR CALIBRATION



EXCHANGE CALIBRATION



DEW POINT CALIBRATION



PRESSURE CALIBRATION



TEMPERATURE CALIBRATION



Benefits

- ✔ SUTO owned high tech calibration facilities for Dew Point, Compressed Air Flow, Oil vapor, Pressure, Temperature in Germany, Hong Kong and China
- ✔ Flow calibration under pressure and a wide range for highest accuracy
- ✔ Real gas calibration system for technical gases
- ✔ SUTO Exchange Calibration Service to minimize downtimes
- ✔ References and certificates are traceable to national standards

Flow Calibration Service

- Accuracy: < 0.5 % o. RDG
- Range: 0 ... 260 m/s (20 °C 1000 mbar)
- Pressure: 0 ... 0.7 MPa
- Pipe sizes: DN8 ... DN100
- Medium: Compressed Air and technical Gasses
- References: Sonic Nozzles, Laminar Flow Elements, Turbine Meter, Coriolis Meter

Instrument		Serial number	
Flowmeter	1000	1000	1000
Serial number	1000	1000	1000

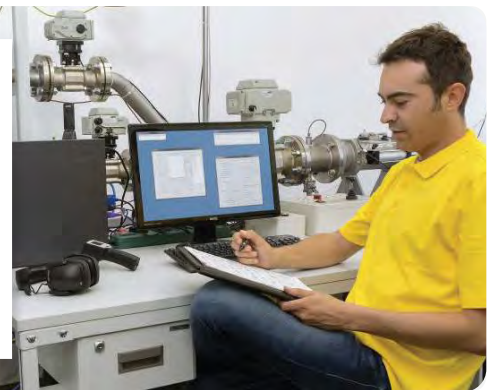

Dew Point Calibration Service

- Accuracy Frost/Dew point: $\leq \pm 0.1 \text{ }^\circ\text{C}$
- Accuracy Temperature: $\leq \pm 0.07 \text{ }^\circ\text{C}$
- Calibration Range: -85 ... +15 °C Td
- Reference: MBW 373 Dew Point Hygrometer / Dew Point Mirror

Instrument		Serial number	
Dew Point	1000	1000	1000
Serial number	1000	1000	1000



Oli Vapor Calibration Service

- Accuracy: $\leq \pm 3 \%$ o. RDG
- Gas: Isobutylene in synthetic air
- Reference: Traceable and certified gas
- Range: 0.000... 10.000 mg/m³
- Multiple activated carbon filtration system for accurate zero-point calibration

Instrument		Serial number	
Oli Vapor	1000	1000	1000
Serial number	1000	1000	1000



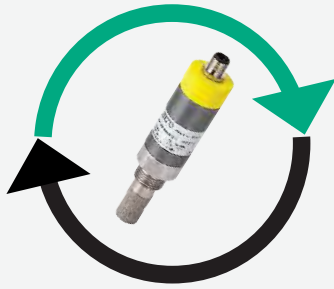

STC | Exchange Service

Exchange Service

No Downtime anymore!

The exchange calibration service eliminates down time and enables users to have a seamless record of their dew point measurements.

The user receives in advance a calibrated instrument with calibration certificate and the same instrument settings. The onsite instrument is then switched against the calibrated one and returned to the supplier.

Ordering

Please use the following table to assist in placing your order with our sales staff.

Calibration and Certification

Order No.	Description
R200 0001	Flow calibration with certificate
R200 0005	Oil-& grease-free cleaning option for flow sensors (For Oxygen, it is already included in A1009.)
R200 0020	Re-calibration, real gas: O ₂ , Ar, CO ₂ , H ₂ (H ₂ real gas calibration needs to consult with manufacturer in advance)
R200 0021	Re-calibration, real gas: CH ₄ , NG, N ₂ O (please consult with manufacturer in advance)
R200 0022	Real gas calibration for He
R200 0030	Pressure sensor calibration 16bar(g) type, at 3 points
R200 0040	Re-calibration ultrasonic flow meter S460
R200 0050	Dew point calibration, one additional point, freely selectable in the range -75 ... +20 °C Td
R200 0070	Calibration for S531
R200 0080	Re-calibration per unit for S110 power meters or Rogowski coils
R200 0120	General service and re-calibration: - General inspection of the unit - Replacement of tubes and fittings - Cleaning of lamp and sensor - Assembly and test of unit - Calibration of oil sensor S120
R200 0130	Calibration for particle counter S130
R200 0131	Calibration for particle counter S132
R200 0600	S600 Service and calibration: - General inspection of the unit - Replacement of tubes and fittings - Cleaning of components - Calibration oil vapor, particle and dew point sensor - Assembly and test of unit - Calibration
R200 0610	Isokinetic sampler service / flow calibration
R699 3396	Dew point sensor calibration
R200 4610	Calibration for S461 ultra sonic transducer pair
R200 4613	Calibration for S461 temperature sensor
R200 4620	Calibration for S462

Accessories



Ordering

Please use the following table to assist in placing your order with our sales staff.

Order No.	Description	Application	Picture
C190 0002	Closing cap for S421/S452 material: 1.4404	To close the measuring sections in case the sensor unit is removed	
C190 0060	Thread adaptor, G 1/2" internal to PT 1/2" external, SUS303	Used to adapt S401 or S450 to a PT thread ball valve	
C190 0065	Thread adaptor, G 1/2" internal to NPT 1/2" external, SUS303	Used to adapt S401 or S450 to a NPT thread ball valve	
C190 0116	Flow conditioner	Wafer type flow conditioners, which is flanged between two flanges 5-8 times diameter upstream of the flow meter. Please specify nominal pipe diameter and pressure	
A530 1105 / A530 1106 / A530 1111 / A530 1113	High pressure installation device. To be used for pressure > 1.5 MPa	For safety reasons we recommend using this installation device whenever the operating pressure exceeds 1.5 MPa * A530 1105 - High pressure installation device for S400/S401-220 mm * A530 1106 - High pressure installation device for S450-220 mm * A530 1111 - High pressure installation device for S400/S401-400 mm * A530 1113 - High pressure installation device for S450-400 mm	
A530 1108	SUTO spot drilling device G 1/2" for S401, S450 and S409	This drilling tool is used to drill holes into compressed air pipes under pressure through a ball valve	
A530 1205	HT20 G 3/4" hot tapping tool, for S430	Drill 3/4" holes into compressed air pipes under pressure through ball valves	
A553 0104	Sensor cable 5 m with M12 connector, open wires, AWG 24 (0.2 mm ²)	Used to connect SUTO sensors to a PLC or power supply	
A553 0105	Sensor cable 10 m with M12 connector, open wires, AWG 24 (0.2 mm ²)	Used to connect SUTO sensors to a PLC or power supply	
A553 0146	Sensor cable 5 m with M12 and RJ45 connectors, PoE supported, AWG 24 (0.2 mm ²)	Used to connect SUTO flow sensors to the Ethernet network via router, switch and etc.	
A553 0161	M8 female to M12 male converter cable	Used to connect the S415/S418 to a Modbus splitter	









Ordering

Please use the following table to assist in placing your order with our sales staff.

Order No.	Description	Application	Picture
A553 0165	Sensor cable, 5 pole, AWG 24 (0.2 mm ²), 50 m	Used to connect power supply and analogue signals to sensors	
A553 0166	Sensor cable, 5 pole, AWG 24 (0.2 mm ²), 100 m	Used to connect power supply and analogue signals to sensors	
A553 0167	RS-485 cable, 4 pole twisted pairs, AWG 24 (0.2 mm ²), 50 m	Used to connect power supply and RS-485 signal to sensors	
A553 0168	RS-485 cable, 4 pole twisted pairs, AWG 24 (0.2 mm ²), 100 m	Used to connect power supply and RS-485 signal to sensors	
A554 0009	Power supply for hat rail, input: 85 ... 264 VAC, output: 24 VDC, 60 W	This power supply can be used to supply sensors with 24 VDC/2.5 A It's mounted on a hat rail	
A554 0007	Power supply wall mountable, input: 85 ... 264 VAC, output: 24 VDC, 15 W, without cable	This power supply is used to supply 24 VDC to sensors and other devices	
A554 0008	½" G type ball valve	This is a proper ball valve for the installations of flow sensors S401/S450	
P554 0009	Wall thickness meter	The instrument is used to measure the wall thickness of pipes. Too often the inner diameter of pipes is not exactly known, but this information is required for an accurate flow measurement. By measuring the wall thickness and the pipe size the exact inner diameter can be calculated	
A554 0107	Mains unit 100-240 VAC/24 VDC, 0.5 A for S401 / S201 series, 2 m cable	Simple power supply for a portable S421 or S401 solution (Special plug on request)	
A554 2005	Service kit for sensor configuration including software	This service kit can be used for all SUTO sensors to change settings and check sensors	

Ordering

Please use the following table to assist in placing your order with our sales staff.

Order No.	Description	Application	Picture
A699 3491	Measuring chamber, 2 l/min @ 0.8 MPa, fast connector, without filter, max pressure 1.6 MPa, suitable for all SUTO dew point sensors	For easy connection and disconnection to compressed air system through quick-disconnector	
A699 3492	Measuring chamber, 2 l/min @ 0.8 MPa, 6 mm hose quick connector, without filter, max. pressure 1.6 MPa, suitable for all SUTO dew point sensors	For easy connection and disconnection to compressed air system through quick-disconnector	
A699 3493	By-pass-type chamber with 6 mm hose in and out connection up to 1.6 MPa	This chamber can be used in applications where the measured gas is by-passed through the chamber	
A699 3500	Measuring chamber, 4 l/min @ 0.8 MPa, hose fast connector, with filter, recommended pressure range 0.3 ... 1.5 MPa, convenient dew point measurement of gas/air with SUTO portable dew point meters	The sample gas/air is connected to the chamber through a 6 mm Teflon® hose. The chamber is mounted to the SUTO portable dew point meters through the 1/2" G-type thread connection. Parking and measurement position is selected through the handle at the chamber, which allows quick measurement results	
A699 3501	By-pass-type chamber with 6 mm hose in and out connection up to 1 MPa, convenient dew point measurement of gas/air with SUTO portable dew point meters	This chamber can be used in applications where the measured gas is by-passed through the chamber to avoid any gas/air loss. The chamber is mounted to the SUTO portable dew point meters through the 1/2" G-type thread connection. Parking and measurement position is selected through the handle at the chamber, which allows quick measurement results	
A699 3496	Measuring chamber for dryer installation, 2 l/min @ 0.8 MPa, hose fast connector, without filter, max. pressure 1.6 MPa	The sample gas/air is connected to the chamber through a 6 mm Teflon® hose. The chamber is mounted to stationary S2XX dew point sensors through the 1/2" G-type thread connection. This chamber can be conveniently mounted to the frame or cabinet of a dryer	
A699 3590	High pressure chamber up to 35 MPa	In applications where the pressure is exceeding 1.5 MPa, this chamber can be used. Through the adjustable valve a small purge is set to ensure a gas flow through the sensor element (response time)	
A554 0054	Compressed air quick coupling, female side R 1/2" thread	Connect this quick coupling to a 1/2" ball valve to set up a quick connector for measurement of dew point, oil and particle	
Dew point sensor protection caps		Protection caps are used to protect the dew point sensor element from mechanical impacts or dust. The proper cap selection depends in application. Please contact customer service	

Ordering

Please use the following table to assist in placing your order with our sales staff.

Order No.	Description	Application	Picture
A554 0002	Test pot 11.3 % rH	Is used to check dew point sensors. The pot creates a constant relative humidity of 11.3 %. The resulting dew point is depending on the ambient temperature, at 25 °C it is equal to -6.3 °C	
D500 0005	S51 panel meter, with 4 ... 20 mA input and 2 alarm outputs, 85 ... 265 VAC supply, 96 x 48 mm panel	Installations in dryers or similar equipment as dew point indicator	
C219 0055	M12 connector with RS-485 termination resistor, 120 Ω	Termination resistor for enhancing communication stability of RS-485 network Connect it to the final device of RS-485 network	
A554 3310	M12 RS-485 (Modbus) splitter	Stationary Modbus splitter for easier wiring	
A554 0011	RS-485 Repeater	A repeater is used whenever the bus length of RS-485 exceeds 500 m. After every 500 m of cable distance a repeater is recommended	
A554 0331	RS-485 / USB converter	This converter brings RS-485 to the USB port of the PC.	
D554 0031	8-channel current input module, 0 ... 20 mA, Modbus/RTU	For connecting up to 8 sensors with 0 ... 20 mA / 4 ... 20 mA signal via RS-485 to S330 / S331.	
A554 0087	USB OTG memory stick	USB memory drive for transferring data between SUTO data loggers (S331 / S551 / S120 with display / S130 with display) and a PC. The USB drive has a USB-A and a Micro-USB connector	

POWER CONSUMPTION OVERVIEW IN CATALOG

When setting up a system in which sensors and devices need to be supplied by an external power supply, please refer to the following power consumption table to select the correct power supply.

P/N	Device / Sensor	Power Consumption [W]	
S695 41XX	S401 / S421	4.8 (w/o Display)	5.8 (w/Display)
S695 415X	S415	2.9	
S695 418X	S418	2.9	
S695 419X	S418-V	2.9	
S695 045X	S450 / S452	4.5 (w/o Display)	4.8 (w/ Display)
S695 430X	S430	3.8 (w/o Display)	4.8 (w/ Display)
S695 430X	S430 PoE	4.8 (w/o Display)	5.8 (w/ Display)
S695 0409	S409	3.9	
S695 435X	S435	3.0	
S695 461X	S461	3.6	
S695 462X	S462	2.4	
S699 12XX	S211 / S215 / S220 (2-wire)	0.5	
S699 22XX	S211 / S215 / S220 (3-wire)	1.0	1.2 (w/ Display)
S699 32XX	S211 / S215 / S220 (Modbus/RTU)	1.0	1.2 (w/ Display)
S699 42XX	S211 / S215 / S220 (w/ Pr. Sensor)	1.0	1.2 (w/ Display)
S699 023X	S230 / S231	1.0	
D699 305X	S305	2.88	
D500 033X	S330 / S331	20.0	
D500 0320	S320	15.0	
S604 12XX	S120	5.0 (w/o Display)	10.0 (w/ Display)
S604 13XX	S130 / S132	5.0 (w/o Display)	10.0 (w/ Display)
D500 0601	S601	50.0	
D500 X606	S606	50.0	
D554 0130	S110	1.0	
P554 0134	S110-P	2.0	
S694 XXXX	Pressure Transmitter	0.5	
S693 000X	Temperature Transmitter	0.5	
S554 015X	Electrical Current Transmitter	0.8	

SUTO®

Registered trademark of SUTO iTEC

MODBUS®

Registered trademark of the Modbus Organization, Hopkinton, USA

HART®

Registered trademark of the HART Communication Foundation, Austin, USA

PROFIBUS®

Registered trademark of the PROFIBUS User Organization, Karlsruhe, Germany

Bluetooth® word mark and logos

Registered trademarks of Bluetooth SIG, Inc.

Android™, Google Play

Trademarks of Google LLC

Photos are for reference only. Outlook of products are regulated by real object. Details of this introduction may be subjected to change without further notice. SUTO reserves the right of final explanation on above contents.



www.suto-itec.com

SUTO iTEC GmbH

Grißheimer Weg 21
D-79423 Heitersheim
Germany
Tel: +49 (0) 7634 50488-00
Fax: +49 (0) 7634 50488-19
Email: sales@suto-itec.com

SUTO iTEC (China) Co. Ltd.

D3 Building, Unit A, 11/F, TCL International E City
1001 Zhongshanyuan Road, Nanshan, Shenzhen,
China
Tel: +86 (0) 755 8619 3164
Fax: +86 (0) 755 8619 3165
Email: sales.cn@suto-itec.com

SUTO iTEC (MALAYSIA) SDN.BHD.

NO.1-2-20, Krystal Point Corporate Park,
Lebuh Bukit Kecil 6, Bayan Lepas, 11900 Penang,
Malaysia
Tel: +04 643 1522
Fax: +04 643 1518
Email: sales.my@suto-itec.com

PT. SUTO iTEC INDONESIA

Cempk Mas Office Tower, 8th Floor-RM 8B
Jl. Letjend Suprpto, Jakarta Pusat, 10640
Indonesia
Tel: +6221 428 03853
Fax: +6221 428 03853
Email: sales.id@suto-itec.com

SUTO iTEC (ASIA) Co. Limited

Room 10, 6/F, Block B, Cambridge Plaza,
188 San Wan Road, Sheung Shui, N.T.,
Hong Kong
Tel: +852 2328 9782
Fax: +852 2671 3863
Email: sales.asia@suto-itec.com

SUTO iTEC Inc.

5460 33rd St SE
Grand Rapids, MI 49512
USA
Tel: +1 (616) 800-SUTO
Fax: +1 (616) 800-7886
Email: sales.us@suto-itec.com

SUTO iTEC (Thailand) Co., Ltd.

Head Office: 91/66 Suwinthawong Rd,
Minburi Bangkok 10510
Thailand
Tel: +66 (0)2108 9658
Fax: +66 (0)2108 9658
Email: sales.th@suto-itec.com

Your local SUTO iTEC Agency