

## MANUAL



**Nagman<sup>®</sup>**  
**HYDRAULIC HAND PUMP**  
**HHP 700 / 1000**

## BRIEF PROFILE



An ISO 9001-2015 certified Instrumentation company (since 1972) serving Industries in India & Worldwide thro' the Manufacture & Supply of World-Class Calibration Instruments & Systems like Temperature, Pressure & Signal Calibrators, Black Body Calibration Sources, Pneumatic & Hydraulic Hand Pumps, Dead Weight & Comparison Testers, Calibration Test Benches, etc.

*Dear User,*

*Thank you for selecting **Nagman's Hydraulic Hand Pump** and becoming a proud owner of this Calibration Instrument.*

*We have strived hard to ensure the accuracy of the contents of this manual. We would appreciate any suggestions/feedback to correct any errors noticed and to improve the quality of contents of this Manual*

*Specifications are subject to change owing to continuous development and we reserve rights to effect Changes / Modifications to this Manual.*

*Read the Instructions before starting to use the Product.*

*Wishing you for a long association with us.*

*For any service related issues, please contact [service@nagman.com](mailto:service@nagman.com)*

### **VERSION CONTROL**

<b>Version No.</b>	<b>Updated on</b>	<b>Updated by</b>
V 1.1	01.09.2022	Nagman

## CONTENTS

---

<b>S.No.</b>	<b>Description</b>	<b>Page No.</b>
1.	Introduction .....	5
2.	Specification.....	6
3.	Standard Delivery & Optional Accessories .....	7
4.	Parts Identification .....	8
5.	Connection Diagram .....	9
6.	Safety Instructions .....	10
7.	Operating Instructions .....	12
8.	Troubleshooting / Maintenance.....	14

---

## 1. INTRODUCTION

Nagman's calibration hand pump is designed to manually generate pressure between 700 / 1000 bar (depends on model).

This pump is manufactured with high quality components for calibrating Analog / Digital gauges by comparison method. It can be used for lab and field applications.

**HHP** is an ideal pressure source for calibrating pressure transmitters, pressure transducers and pressure gauges.

There is a Low / High pressure selector switch in the pump, which is used for selecting low/high pressure output. It is fitted with a fine Adjustment valve and a Release valve.

The output pressure / vacuum of the hand pump can be adjusted precisely by the fine Adjustment valve while calibration. Release valve is used for releasing the pressure / vacuum after calibration.

The output pressure model ranges are :

Model	Range
HHP 700	Upto 700 bar
HHP 1000	Upto 1000 bar

## 2. SPECIFICATION

Ranges	Upto 700 / 1000 bar
Gauge / Indicator Connection Port	3/8" (F) BSP
Test Connection Port	1/4" (F) BSP
Medium	Oil / (Water : Optional)
Oil Reservoir Material	Transparent Acrylic
Reservoir Capacity	100 cc
Stabilization time	15 – 20 minutes
Instrument Dimension	240 x 185 x 95 mm (H x W x D)
Instrument Weight (approx.)	1.8 Kg.

### 3. STANDARD DELIVERY & OPTIONAL ACCESSORIES

#### Standard Delivery

- Basic Unit (Hydraulic Hand Pump)
- Hydraulic Oil : 100 cc
- Cap for dust protection
- Set of Seals
- Conformance Certificate
- Instruction Manual

#### Optional Accessories

- Carrying Case (Soft/Hard)
- Analog / Digital Pressure Gauges
- Quick Connector
- Spare Seals Kit
- Hydraulic Hose with end fittings (Length : 1 Meter)
- Water operated Hand Pump
- Suitable Bonded Seals and Nylon Washers for the above adaptors
- Set of Adaptors
  - 1/8" BSP(F) X 1/4" BSP (M)
  - 1/2" BSP(F) X 1/4" BSP (M)      BSP
  - 3/8" BSP(F) X 1/4" BSP (M)
  - 1/8" NPT(F) X 1/4" BSP (M)
  - 1/4" NPT(F) X 1/4" BSP (M)      NPT
  - 1/2" NPT(F) X 1/4" BSP (M)
  - 3/8" NPT(F) X 1/4" BSP (M)

#### 4. PARTS IDENTIFICATION

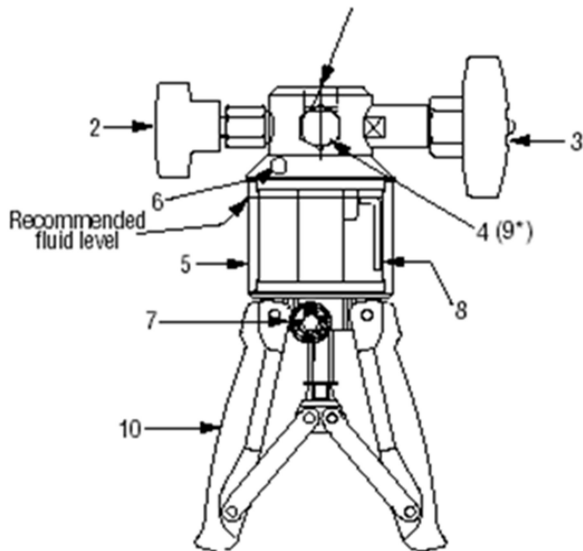

- 1) Connection for ¼" BSP Male adapter to Master Instrument.
- 2) Pressure Release Valve.
- 3) Fine Adjustment Valve
- 4) Front Port: 1/4" BSP female.
- 5) Reservoir
- 6) Reservoir Filling Plug / Safety valve
- 7) Low / High Pressure Selector.
- 8) Fluid Inlet tube.
- 9) Rear Port: ¼" BSP (F) reserved for Pressure Relief Valve. (Do not open)
- 10) Pump Handles





## 5. CONNECTION DIAGRAM



1. Master / Reference Measurement
2. Unit Under Test

## 6. SAFETY INSTRUCTIONS

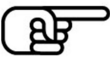
S. No.	Symbol	Description
1		Read the user manual before operating the instrument.
2		Warning - conditions that may pose hazards to the user.
3		Caution-conditions that may damage the instrument.
4		Special Information

- Check all system fittings and connections are tight and leak free.
- Tighten the pressure release valve fully.
- 80% of the required pressure can be developed using handle and the remaining 20% using fine adjustment valve.
- Not to use Synthetic fluids.



- Careful use of the pressure release valve and fine adjustment valve enables a controlled release of pressure, essential for calibration purposes.



- Handles are to be fully squeezed together on each stroke to achieve maximum pressure output.
- Allow the pressure to settle for few minutes before taking the readings, to avoid pressure drop due to thermodynamic effects, setting of seals and expansion of pressure measuring hose.
- As soon as dirt is noticed, change the oil.

- Do not release maximum pressure using Pressure release valve, but use fine adjustment valve to avoid damage to the instrument.



- Do not exceed maximum pressure indicated on pump label.
- It is not advisable to use hydraulic oil operated pump for water / oxygen ranges by removing oil & replacing with distilled water & vice versa. Do not use oil in water operated hand pump as it would damage the inner seals & critical parts.

## 7. OPERATING INSTRUCTIONS

- Remove reservoir filling plug (6) and fill reservoir (5) with the oil / water (whichever specified) up to the marked level and replace plug.
- Turn pressure release valve (2) fully closed in clockwise direction.
- Operate fine adjustment valve (3) & bring it to 'mid-position' in anti-clockwise direction.
- Fully squeeze handles (10) in and turn Low / High pressure selector (7) to low position.
- The following figure shows the selector in Low position

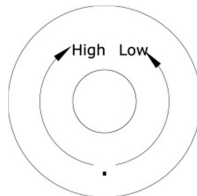

- The following figure shows the selector in High position

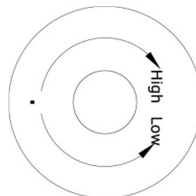

- Connect the Master Instrument to pump (at the top) through connection (1) using the appropriate seals and adaptors.

- Connect the test instrument to flexible hose/gauge adaptor and attach to pump through the quick-fit connection (4).
- Turn pressure release valve fully in anti-clockwise direction.
- Generate pressure by squeezing the pump handles together.
- Ensure selector position kept at Low and the handles are fully squeezed together to achieve up to 30 bar pressure and then change the selector position to high for generating required maximum pressure (depends on model).
- Generate the remaining pressure using fine adjustment valve by turning it in clock-wise direction.
- Selection Low / High depends on the range and easiness of generating of pressure with minimum strokes.
- Release the pressure using the fine adjustment valve by turning it in anti-clockwise direction and then use the pressure release valve by turning one turn in clockwise direction.
- After each operation (water medium), the reservoir must be emptied and let out dry.

## 8. TROUBLESHOOTING / MAINTENANCE

If the HHP fails to develop the Pressure (Increase / Decrease) even after considerable pumping action of the handle, check the following:

- Ensure that the connections between the pump, the hose end and the Test / Master Instrument(s) are tight and then retry pumping.
- Check for any leak at all port connections, and ensure for no trace of oil leak at connection ports.
- Check that the Release Valve is fully closed.
- Pump servicing work should be carried out only by the manufacturer (Nagman).

Chances are there that one of the seals in the HHP is leaking and needs to be replaced, if the applied pressure still cannot be developed.

If functionality of HHP is not normal, please do not Continue Pumping.

If functionality of HHP is not normal, please do not Continue Pumping.

## **Returning Instrument for Service**

When returning the instrument to the manufacturer for service, please provide complete information about the problems faced for clear analysis of the problem. The calibrator should be returned in the original packing.

### **Nagman's liability ceases if :**

- Parts are replaced / repaired using spare parts which are not identical to those recommended by the manufacturer.

Nagman's liability is restricted to errors that originated from the factory.

---

*For more details, write to :*

**NAGMAN INSTRUMENTS AND ELECTRONICS  
PRIVATE LIMITED**

170/1a2, Chennai Bangalore Highway Road,  
Sembarambakkam, Chennai - 600 123. INDIA.

Phone: +91-44-66777000, 011, 022, 033

Email: [support@nagman.com](mailto:support@nagman.com)

Website : [www.nagman.com](http://www.nagman.com)