

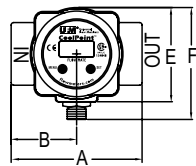

Series CP/CN/CT/CX | U.M. CoolPoint® Vortex Shedding Flowmeter

Specifications - Installation and Operating Instructions



CP2, CP3, CP4

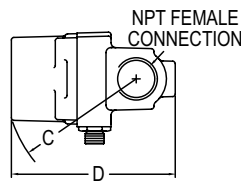

CONTROL BOX CAN BE ROTATED TO ANY OF [4] DETENTED POSITIONS IN 90° INCREMENTS

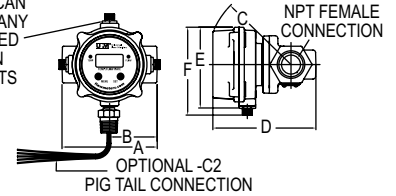

CTx (shown with -C2 pig tail connection)

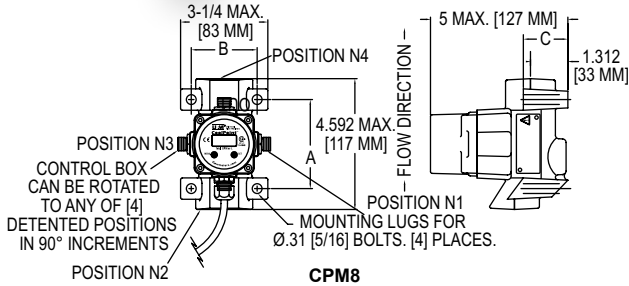

CPM8

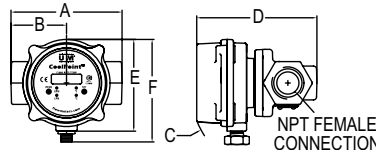

CP/CN6, CP/CN8, CN12, CN16

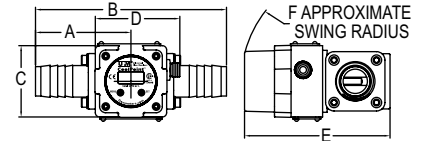

CX8-M7

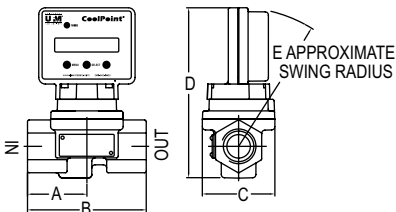

CPX-V8

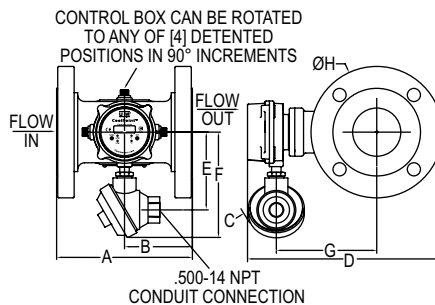

CP24, 32 (shown with -C3/-C14 conduit box)

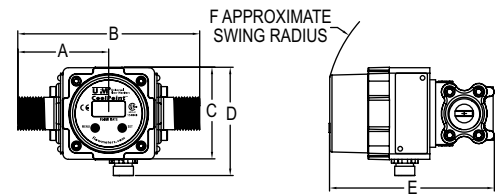

CXX-M5

The Series CP/CN/CT/CX CoolPoint® Vortex Shedding Flowmeter is made for water, water/glycol mixtures, or low viscosity fluids. These units contain no moving parts to clog or wear, allowing for minimal maintenance in the field. This series has two versions: a 3-wire version, where power is supplied separate from the 4-20 mA output, and a 2-wire loop-powered version. The 3-wire version is equipped with a solid state relay that can be configured in the field to be either an alarm or a pulse output, an LED display which allows the user to choose between selectable engineering units (GPM or LPM), and a high temperature option. The alarm on this version is selectable between a high or low alarm (NO or NC) and the pulse output option is set at a frequency at a specific pulses per gallon. The 2-wire option allows for operation in an intrinsically safe mode only when used in conjunction with an approved intrinsic safety barrier meeting required entity parameters. This version does not come with a display or relay contacts to allow for this operation mode.

SPECIFICATIONS

Service: Compatible liquids.

Range: See flow rate chart.

Display: 3-digit or 4-digit LED (pipe sizes > 3"), 0.3" (7.6 mm) digit height; CP-V8: 3-digit LCD (6-digit LCD totalizer mode), 0.3" (7.6 mm) digit height.

Wetted Materials: Flow body: 316 SS or brass; Sensor: PEEK; Seals: FKM.

Accuracy: Flow: ±2% FS; Temperature: ±2°F (±0.1°C) (model selectable).

Repeatability: ±0.25% of reading.

Turndown: 10:1 (20:1 optional).

Temperature Limits: 35 to 210°F (2 to 99°C).

Pressure Limits: 10 to 300 psig (0.7 to 20.7 bar); CP flange and CX: 200 psig (20.7 bar) max.

Response Time: 450 ms.

Power Requirements: 10-30 VDC @ 80 mA standard; 25 mA for 2 wire option; CP-V8: 2 AA alkaline batteries, not included (45 day battery life).

Output: 4-20 mA; 100 pulses per gallon (3-wire models only); 2", 3", and 4": 25 pulses per gallon.

Deadband: Alarm output: 2.5% FS for up to 1/2"; 5% FS for larger than 1/2".

Viscosity: 15 cP max.

Enclosure Rating: NEMA 4X (IP65).

Process Connection: Female NPT, BSPT, or BSPP (model selectable).

Electrical Connection: Male DC micro 5 pin connector; Pigtails or junction box with terminal strip (model selectable).

Weight: CX: 1.5 lb (0.7 kg); CP: 3.3 lb (1.5 kg); CP-V8: 4 lb (1.8 kg); CN, CT: 7 lb (3.2 kg).

Compliance: CE, ETL.

Model	Option	A in [mm]	B in [mm]	C in [mm]	D in [mm]	E in [mm]	F in [mm]	G in [mm]	H in [mm]	
CT2-CT8	Standard	4-1/2 [114.3]	2-1/4 [57.15]	4-3/64 [102.62]	4-59/64 [124.97]	3-3/4 [95.25]	4-3/16 [106.43]	-	-	
CT12, CT16		6-3/4 [171.45]	3-3/8 [85.72]	4-23/32 [119.85]	6-9/64 [155.96]	3-3/4 [95.25]	4-3/16 [106.43]	-	-	
CP2-V8 CP3-V8 CP4-V8		1-53/64 [46.48]	3-21/32 [92.71]	2-3/8 [60.32]	5-29/32 [50.11]	4-61/64 [125.73]	-	-	-	
CP6-V8 CP8-V8		2-1/4 [57.15]	4-1/2 [114.3]	2-3/4 [69.85]	6-7/16 [163.51]	5-17/64 [133.6]	-	-	-	
CP12-V8 CP16-V8		3-3/8 [85.72]	6-3/4 [171.45]	2-7/8 [73.02]	7-11/16 [195.33]	6 [152.4]	-	-	-	
CPM8		2-7/8 [73]	2-1/2 [63.5]	2 [51]	-	-	-	-	-	
CP2, CP3, CP4		C1 and C2 options	3-1/4 [82.55]	1-11/64 [41.15]	3-1/4 [82.55]	4-5/64 [103.38]	2-15/64 [59.44]	2-49/64 [70.36]	-	-
CN6, CN8		4-1/2 [114.3]	2-1/4 [57.15]	3-35/64 [90.17]	4-39/64 [116.84]	2-3/4 [69.85]	3-3/16 [80.96]	-	-	
CP6, CP8		4-1/2 [114.3]	2-1/4 [57.15]	4-3/64 [102.62]	4-59/64 [124.97]	3-3/4 [95.25]	4-3/16 [106.43]	-	-	
CN12, CN16		6-3/4 [171.45]	3-3/8 [85.72]	4-1/4 [107.7]	5-55/64 [148.59]	2-7/8 [73.02]	3-1/4 [82.55]	-	-	
CP24 CT24	7-3/4 [196.85]	3-7/8 [98.55]	8-29/32 [226]	11-1/8 [282.57]	11-1/8 [282.57]	7-1/2 [190.5]	5-47/64 [146]	7-1/2 [190.5]		
CP32 CT32	10-3/4 [273.05]	5-3/5 [136.65]	9-15/32 [240]	12-37/64 [319.48]	12-37/64 [319.48]	9 [228.6]	6-7/16 [163.51]	9 [228.6]		
CP2, CP3, CP4	C3 = Conduit box	3-1/4 [82.55]	1-11/64 [41.15]	5-13/32 [137.16]	4-5/64 [103.38]	2-15/64 [59.44]	6-13/32 [162.81]	-	-	
CN6, CN8	4-1/2 [114.3]	2-1/4 [57.15]	5-11/16 [144.53]	4-39/64 [116.84]	2-3/4 [69.85]	6-51/64 [172.47]	-	-		
CP6, CP8	4-1/2 [114.3]	2-1/4 [57.15]	6-33/64 [165.61]	4-59/64 [124.97]	3-3/4 [95.25]	7-51/64 [198.04]	-	-		
CN12, CN16	6-3/4 [171.45]	3-3/8 [85.72]	6 [152.4]	5-55/64 [148.59]	2-7/8 [73.02]	6-55/64 [173.99]	-	-		
CP12, CP16	6-3/4 [171.45]	3-3/5 [91.44]	6-7/8 [174.5]	6-9/64 [155.96]	3-3/4 [95.25]	7-51/64 [198.04]	-	-		
CT2-CT8	4-1/2 [114.3]	2-1/4 [57.15]	6-3/64 [165.61]	4-59/64 [124.97]	3-3/4 [95.25]	7-51/64 [198.04]	-	-		
CT12, CT16	6-3/4 [171.45]	3-3/8 [85.72]	6-23/32 [174.5]	6-9/64 [155.96]	3-3/4 [95.25]	7-51/64 [198.04]	-	-		
CP24 CT24	7-3/4 [196.85]	3-7/8 [98.55]	8-29/32 [226]	11-1/8 [282.57]	11-1/8 [282.57]	7-1/2 [190.5]	5-47/64 [146]	7-1/2 [190.5]		
CP32 CT32	10-3/4 [273.05]	5-3/5 [136.65]	9-15/32 [240]	12-37/64 [319.48]	12-37/64 [319.48]	9 [228.6]	6-7/16 [163.51]	9 [228.6]		
CX8	M7 = Hose barb	3-3/16 [80.96]	6-23/64 [161.54]	2-1/2 [63.5]	2-27/32 [72.14]	4-21/32 [118.27]	3-39/64 [91.69]	-	-	
	M8 = Nylon Endcaps	2-1/2 [63.5]	4-61/64 [125.73]	2-13/32 [60.96]	2-13/16 [71.37]	4-21/32 [118.36]	3-39/64 [91.69]	-	-	
CX2, CX3, CX4	T1 = NPT female thread	1-63/64 [50.29]	3-31/32 [100.84]	2-13/32 [60.96]	4-13/16 [122.17]	4-9/32 [108.71]	3-39/64 [91.69]	-	-	
CX6, CX8	T1 = NPT female thread	2-3/8 [60.32]	4-3/4 [120.65]	2-13/32 [60.96]	2-13/16 [71.37]	4-55/64 [123.19]	3-13/16 [96.52]	-	-	
CX2, CX3, CX4	T6 = NPT male thread	2-3/8 [60.32]	4-23/32 [119.85]	2-23/64 [59.94]	2-13/16 [71.37]	4-9/32 [108.71]	3-39/64 [91.69]	-	-	
CX6, CX8	T6 = NPT male thread	3-5/16 [83.82]	6-39/64 [167.89]	2-13/32 [60.96]	2-13/16 [71.37]	4-55/64 [123.19]	3-13/16 [96.52]	-	-	

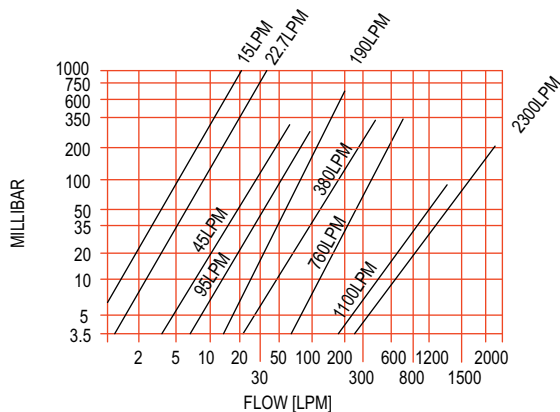
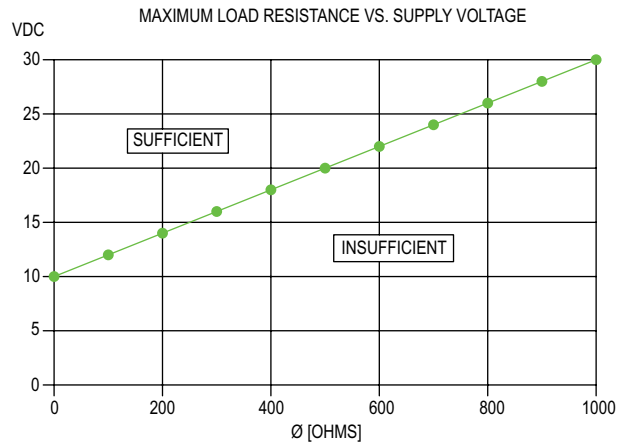
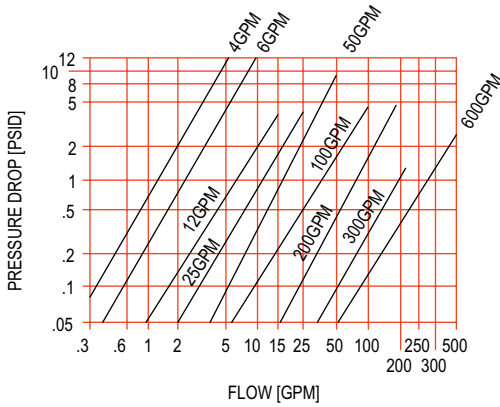

MODEL CHART																																								
Example	CP	2	-M1	T1	C1				-W1	CP2-M1T1C1-W1																														
Series	CX CP CN CT CPM									Polysulfone body vortex shedding flowmeter Metal body vortex shedding flowmeter with rotatable display Metal body vortex shedding flowmeter Metal body vortex shedding flowmeter with temperature sensor and rotatable display Polysulfone body vortex shedding flowmeter with integral lugs integral to body for concrete trucks (only available with pipe size 8 or 1")																														
Pipe Size		2 3 4 6 8 12 16 24 32								<table border="1"> <thead> <tr> <th>GPM</th> <th>LPM</th> <th></th> </tr> </thead> <tbody> <tr> <td>3</td> <td>11</td> <td>1/4" (8 mm)</td> </tr> <tr> <td>6</td> <td>23</td> <td>3/8" (10 mm)</td> </tr> <tr> <td>12</td> <td>45</td> <td>1/2" (15 mm)</td> </tr> <tr> <td>25</td> <td>95</td> <td>3/4" (20 mm)</td> </tr> <tr> <td>50</td> <td>190</td> <td>1" (25 mm)</td> </tr> <tr> <td>100</td> <td>380</td> <td>1-1/2" (40 mm)</td> </tr> <tr> <td>200</td> <td>750</td> <td>2" (50 mm)</td> </tr> <tr> <td>300</td> <td>1136</td> <td>3" (80 mm)</td> </tr> <tr> <td>600</td> <td>2271</td> <td>4" (100 mm)</td> </tr> </tbody> </table>	GPM	LPM		3	11	1/4" (8 mm)	6	23	3/8" (10 mm)	12	45	1/2" (15 mm)	25	95	3/4" (20 mm)	50	190	1" (25 mm)	100	380	1-1/2" (40 mm)	200	750	2" (50 mm)	300	1136	3" (80 mm)	600	2271	4" (100 mm)
GPM	LPM																																							
3	11	1/4" (8 mm)																																						
6	23	3/8" (10 mm)																																						
12	45	1/2" (15 mm)																																						
25	95	3/4" (20 mm)																																						
50	190	1" (25 mm)																																						
100	380	1-1/2" (40 mm)																																						
200	750	2" (50 mm)																																						
300	1136	3" (80 mm)																																						
600	2271	4" (100 mm)																																						
Battery Option			- V8							No battery Battery operated																														
Material				M1 M2 M5 M7 M8						Brass 316 SS Polysulfone Brass with nylon endcaps Brass with nylon hosebarbs																														
Process Connection					T1 T2 T3 T6					NPT female BSPT BSPP NPT male																														
Electrical Connection						C1 C2 C3 C7 C14				Male 5 pin 3-wire pig tail leads 3.3 ft (1 m) Aluminum conduit box 3-wire pig tail leads with PG7 connector 3.3 ft (1 m) 316 SS conduit box																														
Output and Display							- D1 D3 D4E10 D4E1			4-20 mA output with high and low solid state relays 4-20 mA out with 3 digit of rate display (only for series=CPM) Pulse out with 3 digit display of total (only for series=CPM) pulse out no display (only for series=CPM) 4-20 mA out with no display (only for series=CPM)																														
Orientation								- N1 N2 N3 N4		Standard display orientation Flow right Flow up Flow left Flow down																														
Special Options									E14 NIST W1	4-20 mA 2-wire, intrinsically safe NIST traceable calibration certificate 20:1 extended turndown																														

Installation

For best results, the meters may be installed in any position as long as proper piping installation requirements are observed. This includes sufficient support of adjacent piping to minimize the system's inherent vibration. Unions of the same pipe size and full port isolation ball valves may be installed for ease of removal and servicing of equipment, if necessary. Meters should be placed in horizontal, slightly ascending runs or vertical runs to prevent trapped air from accumulating in the meter. Furthermore, the meters should not be placed at the highest point in the piping. The piping system should be filled slowly to prevent water hammer from damaging the flow sensor. Please note that reverse flow can also damage the flow sensor.

In order to achieve the stated accuracy, a straight pipe run of 10 pipe-diameters (minimum) is required upstream of the meter, as well as 5 pipe-diameters downstream. Isolation ball valves, when used, should be in the full open position. Throttling valves should always be placed downstream of the meter. A minimum straight run of 50 pipe-diameters is required between an upstream valve and the flowmeter.

If PTFE tape or pipe sealant is used, the user must ensure that no loose parts become wrapped around the bluff or the flow sensor when flow starts.

Use of diaphragm or piston pumps affects the meter's performance unless they are installed with a properly sized pulsation dampener and pressure control. The piping system must create some back pressure on the meter to allow vortex formation and to prevent cavitation, especially at full flow. Minimum required back pressure is 10 psig at maximum flow and at 70°F (21°C). Higher back pressures are required at elevated temperatures and occasional surges to 125% of maximum flow.

In rare situations, the user may notice an intermittent flow display that drops off while the flow is held steady. In this case, please contact Dwyer Instruments to discuss the back pressure requirements.

Electrical Connections

CAUTION The unit shall be supplied by a Class 2 or SELV (safety extra-low voltage) source in accordance with CSA C22.4 No. 61010-1-012. Failure to do so may result in equipment damage.

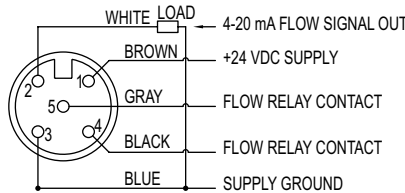

CP
[FLOW ONLY]
WIRING

- PIN CONFIGURATION:**
 1: +24 VDC POWER SUPPLY
 2: 4-20 mA FLOW SIGNAL OUT
 3: POWER SUPPLY GROUND
 4: FLOW RELAY CONTACT
 5: FLOW RELAY CONTACT

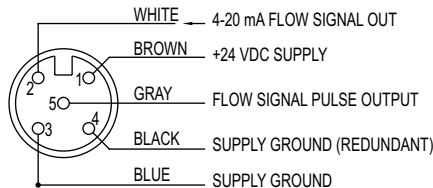

- CONFIGURATION:**
 1: +24 VDC POWER SUPPLY
 2: NOT USED
 3: SUPPLY GROUND
 4: SUPPLY GROUND
 5: FLOW SIGNAL PULSE OUTPUT
 NOTE: THERE IS AN INTERNAL 10K Ω PULL-UP RESISTOR ON THE PULSE OUTPUT LINE (PIN 5).

Totalizer with pulse output

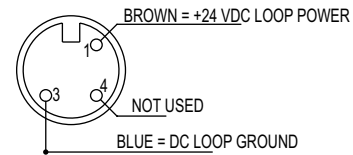

CX2 wire transmitter

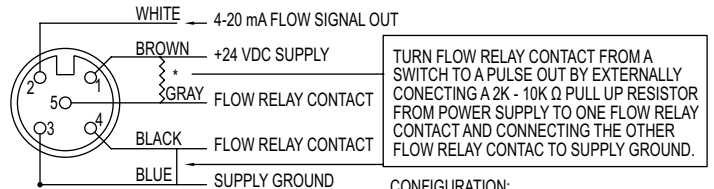

- CONFIGURATION:**
 1: +24 VDC POWER SUPPLY
 2: 4-20 mA FLOW SIGNAL OUT
 3: SUPPLY GROUND
 4: FLOW RELAY CONTACT
 5: FLOW RELAY CONTACT

PIN connector standard wiring

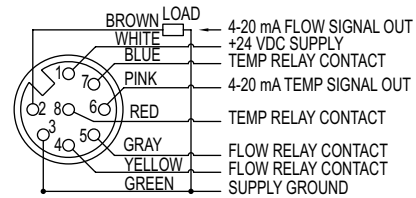

- PIN CONFIGURATION:**
 1: +24 VDC POWER SUPPLY
 2: 4-20 mA FLOW SIGNAL OUT
 3: POWER SUPPLY GROUND
 4: FLOW RELAY CONTACT
 5: FLOW RELAY CONTACT
 6: 4-20 mA TEMP SIGNAL OUT
 7: TEMP RELAY CONTACT
 8: TEMP RELAY CONTACT

CT (flow and temperature) wiring

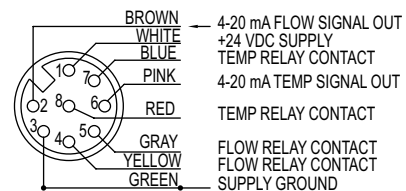

CT wiring

Operation

The CoolPoint® inline flowmeter utilizes the vortex shedding principle. The fluid strikes a bluff body, generating vortices (eddies) that move downstream. The vortices form alternately, from one side to the other. A piezoelectric sensor housed in a sensor tube directly downstream of the bluff senses the pressure zones created by the vortices. The sensor generates a frequency directly proportional to the vortices (flow). The pulses are then amplified by the circuit board and converted to a 4-20 mA output, which is also linear with flow. Flow is displayed on the LEDs in either GPM or LPM. Selection of the preferred units of measure is made by using the SET push button. A solid-state relay can also be set for a low-flow alarm, typically from 15% to 90% of full-scale flow. The relay can be configured to be either NC (normally-closed) or NO (normally-open), or for a pulse output.

FLOW SET POINT RANGES						
Meter Size	Setpoint Min.		Setpoint Max.		Hysteresis	
	GPM	LPM	GPM	LPM	GPM	LPM
1/4"	0.4	1.5	3	12	0.1	0.4
3/8"	0.6	2.3	6	23	-	-
1/2"	1.2	4.5	12	45	-	-
3/4"	3	11	22.5	85	1.2	5
1"	7.5	30	45	170	2.5	9
1 1/2"	15	56	90	341	5	18
2"	30	113	180	682	10	37
3"	40	151	280	1059	15	57
4"	80	302	560	2119	30	114

CT flowmeters can combine temperature measurement with the flow-measuring feature. An internal temperature sensor, housed in a small thermowell downstream of the flow sensor, measures the liquid temperature. Temperature can be displayed in either degrees Fahrenheit or Celsius, and is selected by using the SET push button. There is an independent 4-20 mA output proportional to temperature and an independent solid-state relay that can be configured as a high temperature alarm. The relay state (NC or NO) is the same as that selected for flow alarm. The user can select either flow or temperature to be displayed on the LEDs by using the MENU push button.

TEMPERATURE SET POINT RANGES						
Meter Size	Setpoint Min.		Setpoint Max.		Hysteresis	
	°F	°C	°F	°C	°F	°C
All CT Models	35	1	200	93	4	2

Cleaning: These meters do not require any special cleaning of the external surfaces. If cleaning is deemed necessary, strong solvents, detergents, or chemicals should not be used. A damp cloth may be used to wipe off dirt or debris.

SETUP AND CONFIGURATION

Factory Default Settings

Flow Units: GPM

Set Point: 00.0. NO/NC is set to NC. Flow averaging filter set to F 08.

Temperature Units: °F

Initial Power Up

Upon supplying the initial DC power, the unit goes into a set-up mode. First, it will energize the LED display, showing that all segments of the display functions (8.8.8. is displayed), along with the GPM/LPM LEDs. Then it will display the firmware revision by stating the revision (4.5P for example). Then finally, it will go into the run mode and give the flow rate (or if no flow, 00.0).

When a flow alarm occurs, the second LED (either GPM or LPM) will blink as a visual indicator. Please note the solid LED indicates engineering units of the display and blinking indicates a flow alarm.

One of the two LEDs is lit all the time. Use the SET push button to toggle between the two. If flow is available, the GPM and LPM flow rates will be displayed (again the LPM flow rate is greater than the GPM).

Model CT

In addition to the above-mentioned LEDs, there are two more individual LEDs for temperature – °F and °C. If the meter is displaying flow, these LEDs are off. Use the MENU push button to toggle between "flow" and "temperature" displays.

When the "temperature" display is selected, the GPM and LPM LEDs turn off and either the °F or the °C LED lights up. Use the SET push button to toggle between °F and °C.

Flow Alarm - If a low-flow alarm occurs while the meter is displaying temperature, both GPM and LPM LEDs start blinking. If the meter is in "flow" display mode, the °F and °C LEDs remain off and either the GPM or LPM LED blinks.

Temperature Alarm – If a high-temperature alarm occurs while the meter is displaying flow, both °F and °C LEDs start blinking. If the meter is in "temperature" display mode, both the GPM and LPM LEDs remain off, and either the °F or °C LED blinks.

Configuring the solid state relay as alarm output:

1. Make sure the meter is in "flow" display mode. The MENU push button is used to toggle between the "flow" and "temperature" displays. When in "flow" mode, either the GPM or the LPM LED lights up (both °F and °C LEDs will be off).
2. Press and hold MENU.
3. "FLo" is displayed, followed by either "PUL" (for pulse output) or "ALA" (for alarm output).
4. Release the MENU push button.
5. If "ALA" is displayed, press the SET push button.
6. If "PUL" is displayed, use the MENU push button to change it to "ALA", then press the SET button.
7. The 3-digit value that is displayed is the alarm set point (as stored in the memory).
8. Use the MENU button to change the alarm set point, if needed.
Note 1: When MENU is pressed once, the display increments to the next value. If the MENU button is held down, the display will initially increment slowly, then increment more quickly until the maximum allowed set point is reached. It will then roll over to 0 and start from the minimum set point again. Please refer to Table 1 for the range of acceptable flow set points for each flowmeter size.
Note 2: When the set point is 0, the flow alarm is disabled.
9. Press the SET push button to store the new set point in the memory.
10. The LED then displays either "nc" (normally-closed) or "no" (normally-open). This is the state of the relay when there is no flow alarm.
11. Use the MENU push button to toggle between "nc" and "no".
12. Use the SET push button to store the new relay configuration in memory.

Alarm Relays and Pulse Output

Both CP and CT models can be configured by the user to transmit either a flow alarm signal or a scaled-pulse output. An internal solid-state relay (SSR) is shared between the flow alarm and pulse output.

Model CT has an additional SSR (independent of flow) for transmitting the temperature alarm.

The user menu is entered by pressing (and holding) the MENU push button. In this mode, all subsequent selections must be made within 5 seconds of each other. A period of inactivity (not touching the push buttons) longer than 5 seconds results in the meter's reverting back to normal run mode, without storing the new selection in the memory.

Note: The "LSP" and "HSP" relay contacts are independent of each other and can be set to "nc" or "no" for the flow alarms. When either or both of the alarms are on, the alarm LED will blink.

Configuring the solid state relay as pulse output:

In order to configure the flowmeter for scaled-pulse output, proceed as follows:

1. Make sure the meter is in "flow" display mode. The MENU push button is used to toggle between the "flow" and "temperature" displays. When in "flow" mode, either the GPM or the LPM LED lights up (both °F and °C LEDs will be off).
2. Press and hold MENU.
3. "FLo" is displayed, followed by either "PUL" (for pulse output) or "ALA" (for alarm output).
4. Release the MENU push button.
5. If "PUL" is displayed, press the SET push button.
6. If "ALA" is displayed, use the MENU push button to change it to "PUL", then press the SET button.

Pulse Output: There is an output pulse proportional to flow "rate" as well. The pulse output always indicates flow in GPM. It is driven by an internal solid-state relay with a 10K pull-up resistor to supply voltage (pulse width = 3 msec). It should be noted that the pulse output represents instantaneous flow rate, not an averaged value. Therefore, flow jitter may be present when an external rate indicator is used, unless the indicator is capable of filtering or signal averaging.

The totalizer resolution and the corresponding flow rate pulse output depend on the full-scale setting of the flowmeter, as follows:

Configuring the Temperature Alarm

Only model CT can be configured by the user to transmit a temperature alarm. An internal solid-state relay (independent of flow) is used as a "high alarm" for temperature, meaning that the alarm signal is transmitted when the temperature set point is exceeded.

In order to configure the temperature alarm output, proceed as follows:

1. Make sure the meter is in "temperature" display mode. The MENU push button is used to toggle between the "flow" and "temperature" displays. When in "temperature" mode, either the °F or the °C LED lights up (both GPM and LPM LEDs will be off).
2. Press and hold MENU.
3. "t" is displayed, followed by "AL".
4. Release the MENU push button.
5. The 3-digit value that is displayed is the alarm set point (as stored in the memory).
6. Use the MENU button to change the alarm set point, if needed.
Note 1: When MENU is pressed once, the display increments to the next value. If the MENU button is held down, the display will initially increment slowly, then increment more quickly until the maximum allowed set point is reached. It will then roll over to 0 and start from the minimum set point again. Please refer to Table 2 for the range of acceptable temperature set points.
Note 2: When the set point is 0, the temperature alarm is disabled.
7. Press the SET push button to store the new set point in the memory.
Note: The state of the SSR ("nc" - normally-closed) or ("no" - normally-open) is the same as the flow alarm relay, and can only be changed in the flow alarm menu, regardless of whether the meter is configured for flow alarm or flow pulse output. In other words, in order to select "no" or "nc" for temperature alarm relay, you must repeat Steps 1-12 under "Configuring the Flow Alarm". Later, if the meter is re-configured for scaled-pulse output (flow), it does not affect the temperature relay state.

Configuring response time in filter mode:

The response time for all models (except E4 or D2) can be configured by the user in the range of 0.9 to 7.5 seconds (63% step response). This is achieved by adjusting the "filtering" array size. Slower response typically provides a more steady output signal, as the instantaneous flow variation (dependent on pump, piping, etc.) is averaged out.

It should be noted that the response time refers to the D/A (analog 4-20 mA) output of the flowmeter. The LED display has a slower update rate.

In order to set the response time, proceed as follows:

1. Make sure the meter is in "flow" display mode.
2. Press and hold the MENU button until "Flo" is displayed.
3. Release the MENU button.
4. Depending on the output mode, either "PUL" or "ALA" will be displayed.
5. After approximately 5 seconds "FLt" will be displayed.
6. When "FLt" is displayed, press the SET button.
7. The current filter setting will be displayed (2, 4, 8, 16, or 32 samples averaged to produce the output). The letter "F" will be a prefix to the filter value.

Response time for each setting is as shown in the table:

RESPONSE TIME VS. FILTER VALUE	
Filter Value	Response Time (S)
2	0.9
4	1.4
8	2.3
16	4
32	7.5

8. To change the filter array size, press and release MENU. Alternately, you can press and hold the MENU button and see the values scroll.
9. When the desired filter size is selected, press the SET button.
10. After the filter size is changed, the meter will reboot itself for the changes to take effect.

Step Response Graphs for Various Filter Settings

The following graphs show some examples of the step-response behavior of the meter for various filter settings. The output shown is the 4-20 mA flow signal going from zero to full-scale flow, through a 250-Ω load resistor (no filtering on the analog signal as shown). It is recommended that the user utilizes a filter component (e.g., a 0.1"F capacitor across the load resistor) after installation.

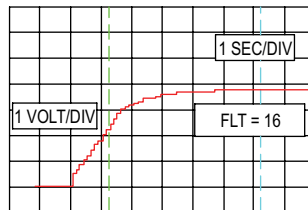
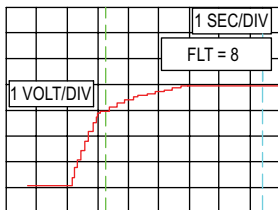
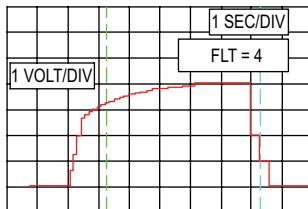

MAINTENANCE/REPAIR

Upon final installation of the Series CP/CN/CT/CX, no routine maintenance is required. The Series CP/CN/CT/CX is not field serviceable and is not possible to repair the unit. Field repair should not be attempted and may void warranty.

WARRANTY/RETURN

Refer to "Terms and Conditions of Sale" in our catalog and on our website. Contact customer service to receive a Return Materials Authorization (RMA) number before shipping the product back for repair. Be sure to include a brief description of the problem plus any additional application notes.

FCC Compliance

This device complies with part 15 of the FCC Rules. Operation is subject to the following two conditions: (1) This device may not cause harmful interference, and (2) this device must accept any interference received, including interference that may cause undesired operation. Changes or modifications not expressly approved by the party responsible for compliance could void the user's authority to operate the equipment.

Note: This equipment has been tested and found to comply with the limits for a Class A digital device, pursuant to part 15 of the FCC Rules. These limits are designed to provide reasonable protection against harmful interference when the equipment is operated in a commercial environment. This equipment generates, uses, and can radiate radio frequency energy and, if not installed and used in accordance with the instruction manual, may cause harmful interference to radio communications. Operation of this equipment in a residential area is likely to cause harmful interference in which case the user will be required to correct the interference at his own expense. CAN ICES-003(A) / NMB-003(A)

This Class A digital apparatus complies with Canadian ICES-003

Cet appareil numérique de la classe A est conforme à la norme NMB-003 du Canada

